

THE STRAMIT *book of* answers[®]

SECOND EDITION

IMPORTANT NOTICE AND DISCLAIMER

The information contained within this book is for general use and information only. Before application in a particular situation, Stramit recommends that you obtain appropriate independent qualified expert advice confirming the suitability of product(s) and information in question for the application proposed. While Stramit accepts its legal obligations, be aware however that to the extent permitted by law, Stramit disclaims all liability (including liability for negligence) for all loss and damage resulting from the use of the information provided in this brochure.

© April 2021 Stramit Corporation Pty Limited ABN 57 005 010 195.
A member of the Fletcher Building Group. Use of ™ and * indicates trade marks of Stramit Corporation Pty Limited.

MagnaFlow® is a registered trademark of Fletcher Building Holdings Limited.

ZAM® is a registered trade mark of Nisshin Steel Co., Ltd.

Sisalation®, Permastop®, Roof Razor®, RoofSafe® and SonoBatts® are registered trademarks of Fletcher Insulation Pty Ltd.

Buildex®, Auto Teks®, Roof Zips® and Square-Lok® are trademarks of Illinois Tool Works Inc.

SUPERDURA™ is a trade mark of BlueScope Steel Limited.
ABN 16 000 011 058.

Colorbond®

The COLORBOND® steel colour swatches and images shown have been reproduced to represent actual product colours as accurately as possible. However, we recommend checking your chosen colour against an actual sample of the product before purchasing, as varying light conditions and limitations of the printing process may affect colour tones. COLORBOND®, ZINCALUME®, Activate®, Thermatech® and * colour names are registered trade marks of BlueScope Steel Limited. ™ colour names are trade marks of BlueScope Steel Limited. ABN 16 000 011 058.



FOREWORD

Once in a while, something comes along that changes the ball game completely.

We created *The Stramit Book of Answers*[®] to do just that.

This book doesn't just give you the numbers – we give you the answers. Why sift through pages of data and do the calculations, when you can get the initial answers straight away.

We've done the work for you, so you can make decisions on the go knowing you're compliant with current building codes and standards. You don't need a computer or calculator either to get a quick indicative answer – simply choose your variables, and we'll give you the answer. You can select your Stramit[®] roofing, walling, rainwater and structural products quickly, knowing that they will work as a complete system.

The Stramit Book of Answers[®] is designed to be the first step towards making the right decisions. Designed as a pocket reference, it contains only the key elements you need for design before you get into the detail available from our other resources like installation instructions and technical manuals.

This book is the product of years of listening to our customers as a business, as well as months of hard work. Together, we have created something that will help so many each and every day.

As always, your local Account Manager is here to help when you're ready to take the next step.

Happy reading,

The Stramit team.

Table of contents

1. About Stramit	6
2. How to use <i>The Stramit Book of Answers</i>[®]	8
3. Stramit by design	12
4. Materials and finishes	14
5. Wind loads	30
6. A complete steel building product solution	38
7. Roofing and wall cladding	41
Roofing and walling general	41
Roofing and walling products	46
Walling products	128
8. Insulation	166
9. Rainwater solutions	174
Quad Gutters	175
Square Gutters	176
Half Round Gutters	177
Metal Fascia	177
10. Purlins and girts	194
11. Top hats	236
12. Roof and ceiling battens	282
13. Formwork	290

14. Flooring	298
15. Roller doors	320
16. Sheds	338
17. Worked example	340
18. Helpful information	352
Design software	355
Our technical services team	356
Material warranties	357
Loading advice	358
Service promise	361
Site conditions checklist	362
Flammability	364
Glossary	366
Hipped roof take-off estimate	382
Helpful tables	386

1. About Stramit

OUR PRODUCTS AND PEOPLE SHAPE HOMES AND COMMUNITIES

Stramit is one of Australia's leading manufacturers and suppliers of roll formed steel building products for the Australian residential, commercial, shed and home improvement industries. A member of the Fletcher Building group, we're passionate about helping improve Australia's built environment.

For us, our role in the building industry is bigger than supplying quality steel roofing, rainwater or structural products. Every day, across the country, we commit to working alongside building professional services and trades to get the job done right, on time, every time — no matter how complex.

We've come a long way

In 2019, Stramit celebrated 30 years in the building business, but our story started long before then. We can trace our history back to various family-owned roofing, rainwater and roll forming businesses — some of which date back to the 1890s. It explains why an entrepreneurial spirit, high quality standards and good old-fashioned customer service runs deep in our DNA today.

Fast forward to 1989. The Stramit we know today was established after KH Stramit and Amatek Building Products joined forces. Since then, we've developed new products which have been recipients of Australian Design Awards. We've also been joined by others who have brought a wealth of experience, including leaders in the roller door business (Taurean Door Systems) and the Australian sheds market (Fair Dinkum Sheds and Shed Boss).

A steel-clad commitment

At Stramit, we understand the successful delivery of projects depends on more than just quality steel roofing, rainwater and structural building products. It depends on a partner you can trust. Our Declaration of Done is our set of promises to our customers that we're in this together. We stand by what we say we'll do and when we don't, we'll fix it. It's our way of making sure we don't let our customers down where it counts most. When you partner with Stramit, you can Consider it Done.



We're invested in our industry

Stramit is one of a very few roll formed steel manufacturers with an in-house research and development facility, which is used exclusively to design, develop and test products for Australian conditions.

When it comes to product development, our Research and Development team works closely with specifiers and customers to identify unmet needs, pain points and emerging building trends. They collaborate with research institutions on how to use new materials and technologies innovatively, and ensure our products are compliant with the National Construction Code (NCC). The result is performance-guaranteed, quality steel building products.

Service you can depend on

With a national footprint supporting local businesses around the country, we make it our business to understand our customers' local challenges so they can depend on us for advice and support to help get the job done.

Our technical services consultants are trusted advisors when it comes to developing the right solutions for projects big and small. Their product knowledge, technical expertise and practical experience create real value through design efficiencies, reduced building costs, and quick and easy installation.

At Stramit, we strive to improve the world around us through smart thinking, simply delivered. From ordering through to invoicing, we continually work on how we can make it easier for our customers to build spaces that will support Australian households, communities and businesses for years to come.

And we'll continue to evolve.

We know the best is yet to come.

2. How to use The Stramit Book of Answers®

HINTS, TIPS AND THE FINE PRINT

All building design is a compromise between strength and economy. In *The Stramit Book of Answers*® we help designers navigate their way through a simplified process to determine if our product-based design solutions are suitable for their project and represent best value for money.

The wind code

As most of Stramit's products are required to withstand wind loads, we reference a simplified version of AS 4055 Wind Loads for Housing. While this wind code is specific to housing in Australia, experienced designers familiar with AS/NZ 1170 part 2, the Wind Load Code, may also be able to utilise the data as both codes follow a similar pattern in their function. A table of the wind loads for cyclonic and non-cyclonic areas has been included to determine design solutions that cross reference both codes.

Roofing and wall cladding

All the Roofing and Wall Cladding pages give the maximum span applicable to suit a set of circumstances. The tables give specific data for a Stramit profile, the fastener frequency, and the batten or purlin material to suit the required wind load category. Variations in any of the design parameters will change the design solution result. The cladding tables are based upon the minimum result of fastener performance, Serviceability Limit State, Strength Limit State and, where applicable, foot traffic performance. For maximum performance and economy, the tables incorporate Internal and End Span cladding limits.

Rainwater

Gutter and downpipe design on domestic structures plays an important role in capturing rainfall on the roof and either carrying it to the underground drainage system or redirecting it to water storage tanks. In both cases, this redirection of rainfall must be done without creating overflow, and therefore potential damage to the structure. The Stramit data provided in *The Stramit Book of Answers*® includes tables to ensure maximum rainwater collection and overflow provisions in the case of extreme weather events.



Purlins and other structural supports

To maintain a common approach, the tables for battens, top hats and the range of Stramit's C&Z Exacta® purlins have all been redesigned so they reflect a cladding span (purlin spacing) applicable to the required wind load category. This simple approach, which allows for different span types, bridging numbers and bolt types, allows direct comparison to the cladding performance (the cladding span) to determine the best fit for the complete system.

Residential floor framing system

The Stramit® Residential Floor Framing System has been included in *The Stramit Book of Answers*® but with a new set of tables to make floor design much easier. Utilising the common Roof Load Width (RLW) process to determine the loads on the floor bearers, these new tables provide the bearer, joist, FCB3 bracket requirements and all the relevant spans needed for a floor project.

Formwork

A single table for Stramit's Condeck HP® composite slab system gives information on propping, slab thickness and visual appearance to suit a range of floor loadings. The table is applicable to single spans only. Continuous span design, with or without fire design, will require additional reinforcement and crack control mesh but will usually result in a thinner slab. A continuously designed slab is outside the scope of *The Stramit Book of Answers*®, which is designed to give simple and economic solutions.

Roller doors

Roller doors are on the external building envelope and are therefore subject to the same wind loads as wall cladding. We include design tables that allow designers to choose a roller or sectional door to suit the design conditions.

The National Construction Code

Stramit® products shown in this publication conform to the following Australian Standards noted in the National Construction Code, as follows.

Steel material

- All metallic coated steel complies with AS 1397
- Painted steel product conforms with AS/NZS 2728

Roofing and wall cladding

- Roofing/walling profiles conform with AS 1562 and AS 4040 parts 1, 2 and 3
- Corrugated roofing conforms with AS 1445
- Wind load data conforms with AS 4055
- Fasteners conform with AS 3566
- Installation details are in accordance with the Standards Australia Handbook HB39

Rainwater solutions

- Gutters and downpipes conform with AS 2179 part 1
- Drainage is calculated to conform with AS 3500 part 3
- Wind loads on fascia are in accordance with AS 4040 part 2

Purlins

- All purlin profiles conform with AS 4600

Formwork

- Stramit's Condeck HP® composite slab system is in accordance with AS 3600 and AS 3610

Explanation of icons



Suitable for
roofing and
walling



Suitable for
walling only



Suitable for
roofing only



Product data for
non-cyclonic areas



Product data for
cyclonic areas



AVAILABLE



NOT AVAILABLE



With a national footprint Stramit can source all products, even if they're not made in a particular region. Speak to your local Stramit representative for more information.

3. Stramit by design

At Stramit, we recognise the design must be appropriate for the conditions and environment while meeting the customer's ideal requirements.

All design solutions must conform to the design rules provided in the relevant Australian Standards while offering

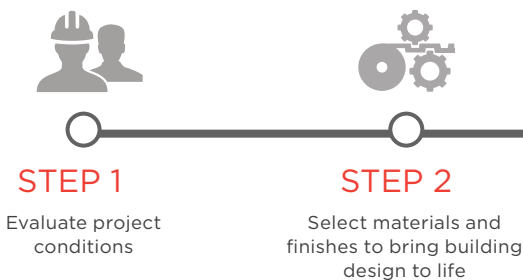

CREATE A BUILDING SPECIFICATION WITH STRAMIT



responsible considerations to cost, appearance, style and ongoing maintenance requirements.

In *The Stramit Book of Answers*[®], we provide specifiers, engineers, building designers and trades with design-related data to evaluate the suitability of Stramit's steel building products for their structures.



STEP 3

Determine the wind load category



STEP 4

Design roof and wall cladding



STEP 5

Assess insulation requirements



STEP 6

Develop a region-specific rainwater solution

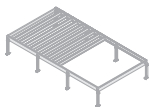

STEP 8

Save time and money with formwork and flooring products



STEP 7

Improve design efficiencies with structural steel products

4. Materials and finishes

MAKE IT YOUR OWN

From traditional galvanised to new generation protective coatings, Stramit® steel building products come in a range of materials and finishes to suit location conditions and architectural design. It's therefore important to start with the end in mind so make time to select materials that are best suited for your project and its local environment. You also need to check that the materials you choose are compatible with other building materials that surround it. The following information on our materials, finishes and colour availabilities will help inform your decision making.

Materials

Australian company BlueScope Steel Limited (BlueScope) supplies Stramit with a range of coated steel in various finishes which enables us to manufacture our metal building products in accordance with the relevant Australian Standards and the National Construction Code of Australia. BlueScope metallic coated steel is made to AS 1397-2021, providing us with the strength and coating class requirements to ensure reliability and long life.

BlueScope offers a variety of warranties subject to product, application and eligibility criteria. You can check what warranties are available and apply for a warranty by visiting BlueScope's website.

Not all materials are available in all products. Please refer to your local Stramit office for details on the local product offer.

Strength

In accordance with AS 1397, Stramit uses G300 (300MPa steel) material for ductile applications such as brackets and flashings. High strength G450, G500 and G550 (450, 500 and 550 MPa steel respectively) material is used where higher strength, damage resistance and lower weight is an advantage.

Thickness

All material thicknesses given in this book are measured in accordance with AS 1397 and are Base Material Thickness (BMT). Total Coated Thickness (TCT) is no longer used as the influx of a wide variety of different coatings—with or without paint—affect the total thickness. As the base metal is also the structural thickness, we recommend only using the BMT as a thickness standard. As a rule, thicker material usually offers better performance.

Coatings

Protective coatings with alloys of zinc, aluminium and magnesium give the steel base protection against corrosion. Coating classes have a naming system with a coating type (Z for galvanised, AM for ZINCALUME® steel and ZM for ZAM® for example) followed by the mass of the coating in grams per square metre (total both sides). AS 1397 has defined coating classes and all metallic coated materials used by Stramit conform to this standard. For more information on the coating class used in each Stramit® product, please refer to the relevant product section of this book. As a rule, thicker coatings of the same type offer increased life.

Stramit also supplies roofing, walling and rainwater products with baked on pre-painted finishes. These pre-painted materials are available in different types to give economical and extended life over a range of different environments. Stramit® purlins and Condeck HP® are also available in different materials to offer better life performance in different environments.

Overpainting

Overpainting and touch up of Stramit® roofing and rainwater products can be accomplished using water based acrylic paints. However, it is not recommended as air drying paint will have different weathering characteristics to the factory applied paint, and could void any manufacturer's warranty*. There is no texture match for COLORBOND® steel Matt, and no colour match for COLORBOND® Metallic steel.

Minor scratches should be ignored unless they are readily seen from the ground, and in the worst cases, the material may require replacement.

**BlueScope does not recommend the use of touch-up paint and a BlueScope warranty will be void if touch-up paints are applied.*

GALVANISED STEEL

Recognised as Australian traditional steel, galvanised cladding is often specified to enrich the appearance of old or traditional buildings.

- Provides cut edge and bend protection to the steel base
- Presents with a large spangle finish
- Available in different coating classes for a range of exposure conditions
- Used for purlins, Condeck HP® and various pressed brackets and accessories

This material should not be used outdoors less than 2km from marine environments.



ZINCALUME® STEEL

Introduced to Australia in the 1970s, you can depend on this durable and resilient coating.

- Next generation ZINCALUME® steel now with Activate® technology
- Provides cut edge and bend protection to the steel base
- Presents a flat, smooth and lightly spangled appearance

The performance of the coating now with Activate® technology, allows this material to be used as close as 200m to a marine environment for roofs, and more than 1km away for commercial and industrial walling.



COLORBOND® STEEL

COLORBOND® steel (XRW prepainted steel for exterior roofing and walling) continues to inspire the Australian building industry with its colour range and long life.

- Tested under Australian conditions
- Five layers of protection
- Activate® technology for improved corrosion performance
- Durable topcoat with Thermatech® solar reflectance technology*

With a steel substrate which includes a aluminium, zinc, magnesium alloy coating, this material can be used as close as 200m to a marine environment for roofs, and more than 1km for walls.

CLASSIC COLOURS

CLASSIC
CREAM™

PAPERBARK®

PALE
EUCALYPT®

COTTAGE
GREEN®

MANOR
RED®

DEEP
OCEAN®

WOODLAND
GREY®

NIGHT SKY®

CONTEMPORARY COLOURS

SURFMIST®

SHALE
GREY™

EVENING
HAZE®

DUNE®

JASPER®

GULLY®

COVE®

MANGROVE®

WINDSPRAY®

WALLABY®

BASALT®

IRONSTONE®

TERRAIN®

MONUMENT®

**Thermatech® technology is not available in the colour Night Sky®.*

COLORBOND® STEEL MATT

This finish effortlessly combines durability and subtlety while creating the perfect backdrop for everyday living spaces.

- Tested under Australian conditions
- Activate® technology for improved corrosion performance
- Five layers of protection
- Durable topcoat with Thermatech® solar reflectance technology*
- Easy to maintain

With a steel substrate which includes a aluminium, zinc, magnesium alloy coating, this material can be used as close as 200m to a marine environment for roofs, and more than 1km for walls.

SURFMIST®
MATT

BASALT®
MATT

MONUMENT®
MATT

*Dune® Matt and
Shale Grey™ Matt
available on request.*

**Thermatech® technology is not available in the colour Night Sky®.*

COLORBOND® METALLIC STEEL

Make a bold metallic statement, with the added advantage of reflective light and colour.

- Designed for prestigious architectural projects with an aesthetically distinctive metallic effect
- Supports bold design while remaining strong and durable
- Tested in Australian conditions
- Activate® technology for improved corrosion performance
- Durable topcoat with Thermatech® solar reflectance technology* and metallic lustre

To maintain appearance and longevity, do not use this material less than 1km from marine environments for commercial or industrial applications, or 2km for residential buildings.

GALACTIC®

COSMIC®

RHEA®

ASTRO®

ARIES®

CELESTIAN®

**Thermatech® technology is not available in the colour Night Sky®.*



COLORBOND® ULTRA STEEL

More protection for buildings in severe coastal and industrial environments with an improved substrate system.

- Specifically designed for severe coast and industrial environments
- Tested in Australian conditions
- Thicker aluminium, zinc and magnesium alloy coating for additional durability
- Durable topcoat with Thermatech(R) solar reflectance technology*
- Easy to maintain

This material is suitable for use at sites greater than 100m from marine environments for roofs, or 500m for walls.

SURFMIST®

DUNE®

WINDSPRAY®

WALLABY®

WOODLAND
GREY®

MONUMENT®

**Thermatech® technology is not available in the colour Night Sky®.*



SUPERDURA™ STAINLESS STEEL

Choose a stainless steel substrate for structures within 100m of severe environments.

- Tested in Australian conditions
- BlueScope's ultimate pre-painted product in corrosion resistance and weatherability in exterior applications
- Durable topcoat with Thermatech® solar reflectance technology*

For applications closer than 100m to the marine environment, for both roofs and walls, this material has the best performance of all the available materials.

SURFMIST®

DUNE®

WINDSPRAY®

DEEP
OCEAN®

**Thermatech® technology is not available in the colour Night Sky®.*

ZAM[®]

Developed by Nisshin Steel, this new generation coating technology provides exceptional corrosion resistance for thicker sections such as purlins, girts and floor systems.

- Suitable for severe environments
- Aluminium, zinc and magnesium material elements combine to form a protective barrier on the coating surface over time
- Provides additional protection for purlins and Condeck HP[®] composite slab system
- Replaces the need for higher coating weights
- Provides raw edge protection and is concrete compatible and scratch resistant
- Can replace stainless steel and aluminium in some applications

Designed for the environments that are normally not covered by galvanised steel, ZAM[®] complies with AS 1397. Warranties for this material are supplied on a project basis.

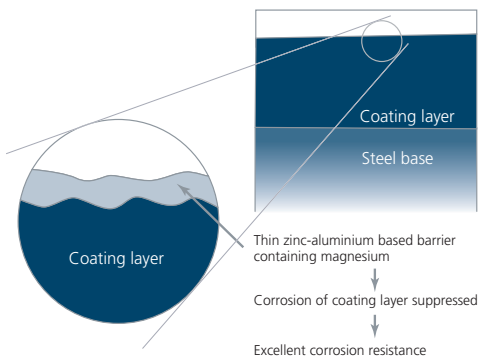

PCC MAGNAFLOW®

Apply MagnaFlow® sheeting to your steel building projects for more durability and protection in corrosive environments.

- ZAM® base for maximum protection
- Delivers more durable site performance than normal unpainted or painted products
- Suitable for severe environments
- Scratch, impact, heat and humidity resistant
- Applied to Stramit materials by New Zealand-based Pacific Coil Coaters (PCC)

For exposed applications where durability is paramount, MagnaFlow® sheeting has a tough paint system applied to a ZAM® base. Warranties are available from Stramit to suit the application.

OFF WHITE

ARMOUR

BIRCH

MONOLITH

SLATE GREY



Flammability

Stramit® roofing, cladding, rainwater and structural building products are manufactured from steel produced by BlueScope or Unicote®. Both organisations have their materials independently tested to ensure flammability thresholds comply with the National Construction Code (NCC). In Australia, the testing is conducted by CSIRO and AWTA in accordance with AS 1530.3 Simultaneous Determination of Ignitability, Flame Propagation, Heat Release and Smoke Release.

Table 4.1 Results summary

Product	Ignitability index (0-20)	Spread of flame index (0-10)	Heat evolved index (0-10)	Smoke developed index (1-10)
Galvanised steel	0	0	0	2
ZINCALUME® steel	0	0	0	2
Pre-painted steel	0	0	0	2

Direct contact between materials

To ensure the best result when combining materials, always consider the environment as this may have a marked effect of the life of the materials. Please also ensure that any accessory or flashing material attached to the roof or wall cladding complies with the following table.

Table 4.2 Direct contact between materials

Cladding material	Accessory or flashing material																								
	ZINCALUME® steel		COLORBOND® steel		COLORBOND® Metallic steel		COLORBOND® Ultra steel		SUPERDURA™ Stainless steel		Galvanised		Al-Zn coated steel		Aluminium		Copper		Zinc		Lead		PCC Magnaflow®		
	Mild	Severe	Mild	Severe	Mild	Severe	Mild	Severe	Mild	Severe	Mild	Severe	Mild	Severe	Mild	Severe	Mild	Severe	Mild	Severe	Mild	Severe	Mild	Severe	
ZINCALUME® steel	Yes	Yes	Yes	Yes	Yes	Yes	Yes	No	No	Yes	Yes	Yes	Yes	Yes	Yes	No	No	No	No	Yes	Yes	Yes	Yes	Yes	Yes
COLORBOND® steel	Yes	Yes	Yes	Yes	Yes	Yes	Yes	No	No	Yes	Yes	Yes	Yes	Yes	Yes	No	No	No	No	Yes	Yes	Yes	Yes	Yes	Yes
COLORBOND® Metallic steel	Yes	Yes	Yes	Yes	Yes	Yes	Yes	No	No	Yes	Yes	Yes	Yes	Yes	Yes	No	No	No	No	Yes	Yes	Yes	Yes	Yes	Yes
COLORBOND® Ultra steel	Yes	Yes	Yes	Yes	Yes	Yes	Yes	No	No	Yes	Yes	Yes	Yes	Yes	Yes	No	No	No	No	Yes	Yes	Yes	Yes	Yes	Yes
SUPERDURA™ Stainless steel	No	No	No	No	No	No	No	Yes	Yes	No	No	No	No	Yes	Yes	No	No	No	No	Yes	Yes	Yes	Yes	No	No
Galvanised	Yes	Yes	Yes	Yes	Yes	Yes	Yes	No	No	Yes	Yes	Yes	Yes	Yes	Yes	No	No	No	No	Yes	Yes	Yes	Yes	Yes	No
Al-Zn coated steel	Yes	Yes	Yes	Yes	Yes	Yes	Yes	No	No	Yes	Yes	Yes	Yes	Yes	Yes	No	No	No	No	Yes	Yes	Yes	Yes	Yes	No
Aluminium	Yes	Yes	Yes	Yes	Yes	Yes	Yes	No	No	Yes	Yes	Yes	Yes	Yes	Yes	No	No	No	No	Yes	Yes	Yes	Yes	Yes	Yes
Copper	No	No	No	No	No	No	No	No	No	No	No	No	No	No	Yes	Yes	Yes	Yes	Yes	No	No	No	No	No	No
Zinc	Yes	Yes	Yes	Yes	Yes	Yes	Yes	No	No	Yes	Yes	Yes	Yes	Yes	Yes	No	No	No	No	Yes	Yes	Yes	Yes	Yes	No
PCC Magnaflow®	Yes	Yes	Yes	Yes	Yes	Yes	Yes	No	No	Yes	Yes	Yes	Yes	Yes	Yes	No	No	No	No	Yes	Yes	Yes	Yes	Yes	Yes

BlueScope branded materials Mild environments are more than 1 km from marine or industrial pollution areas
 Other materials Severe environments occur up to 200m from marine areas

Accessory material compatibility

Smaller accessories and fasteners used on Stramit® cladding need to be compatible with the sheeting itself. Any sealing washers must not contain any carbon black material.

Table 4.3 Accessory material compatibility

Cladding material	Accessory or fastener material									
	ZINCALUME® steel	Galvanised steel	Al-Zn coated steel	Zinc	Stainless (300 series)	Aluminium	Copper and Brass	Lead	Monel	Carbon black
ZINCALUME® steel	Yes	Yes	Yes	Yes	No	Yes	No	No	No	No
COLORBOND® steel	Yes	Yes	Yes	Yes	No	Yes	No	No	No	No
COLORBOND® Metallic steel	Yes	Yes	Yes	Yes	No	Yes	No	No	No	No
COLORBOND® Ultra steel	Yes	Yes	Yes	Yes	No	Yes	No	No	No	No
SUPERDURA™ Stainless steel	No	No	No	No	Yes	No	No	No	No	No
Galvanised	Yes	Yes	Yes	Yes	No	Yes	No	Yes	No	No
Al-Zn coated steel	Yes	Yes	Yes	Yes	No	Yes	No	No	No	No
Zinc	Yes	Yes	Yes	Yes	No	Yes	No	Yes	No	No
PCC Magnaflow®	Yes	Yes	Yes	Yes	No	Yes	No	No	No	No

BlueScope branded materials

Other materials

Roof drainage

Water flow from one roof to another, or into a gutter profile, must comply with this table. Non-conformance will lead to premature failure of the lower roof sheet or gutter system.

Table 4.4 Roof drainage

Lower roof or gutter material	Upper roof cladding material													
	ZINCALUME® steel	COLORBOND® steel	COLORBOND® Metallic steel	COLORBOND® Ultra steel	COLORBOND® SUPERDURA™ Stainless steel	Galvanised	Al-Zn coated steel	Stainless Steel	Aluminium	Copper	Zinc	Lead	Inert Materials	PCC Magnatflow
ZINCALUME® steel	OK	OK	OK	OK	OK	OK	OK	NO	OK	NO	OK	NO	OK	OK
COLORBOND® steel*	OK	OK	OK	OK	OK	OK	OK	OK	OK	NO	OK	NO	OK	OK
COLORBOND® Metallic steel	OK	OK	OK	OK	OK	OK	OK	OK	OK	OK	OK	NO	OK	OK
COLORBOND® Ultra steel	OK	OK	OK	OK	OK	OK	OK	OK	OK	OK	OK	NO	OK	OK
SUPERDURA™ Stainless steel	OK	OK	OK	OK	OK	OK	OK	OK	OK	OK	OK	OK	OK	OK
Galvanised	NO	NO	NO	NO	NO	OK	NO	NO	NO	NO	OK	OK	NO	NO
Al-Zn coated steel	OK	OK	OK	OK	OK	OK	OK	OK	OK	OK	OK	NO	OK	OK
Stainless Steel	OK	OK	OK	OK	OK	OK	OK	OK	OK	OK	OK	OK	OK	OK
Aluminium	OK	OK	OK	OK	OK	OK	OK	OK	OK	OK	OK	NO	OK	OK
Copper	OK	OK	OK	OK	OK	OK	OK	OK	OK	OK	OK	OK	OK	OK
Zinc	NO	NO	NO	NO	NO	OK	NO	NO	NO	NO	OK	OK	NO	NO
Inert Materials	OK	OK	OK	OK	OK	OK	OK	OK	OK	OK	OK	OK	OK	OK
PCC Magnatflow	OK	OK	OK	OK	OK	OK	OK	OK	OK	OK	OK	NO	OK	OK

*Includes COLORBOND® steel Matt

BlueScope branded materials

Other materials

Custom colours

Most Stramit® roofing and rainwater products can be manufactured from 22 colours in the COLORBOND® steel range so you can use your steel building materials to set the tone and style of your project.

However, you're not limited to that range.

Our profiles and accessories can be manufactured in the colour of your choice, including special colours to suit personal, corporate or architectural needs. You even have the option to select gloss, paint film or substrate to match your environment.

Minimum quantities apply so contact your local Stramit office to find out how we can help you bring your building design to life through colour.

Summary Checklist

- ✔ Many Stramit® products are available in various material thicknesses
- ✔ Thicker material usually offers more performance
- ✔ Cladding and rainwater products are usually available in unpainted or pre-painted options
- ✔ Pre-painted materials are usually available in a range of material types to meet the exposure conditions
- ✔ Stramit® purlins are also available in different materials to meet the durability requirements

5. Wind loads

All buildings in Australia need to be designed to carry the applicable serviceability and strength wind loads as determined from AS 1170 part 2 or AS 4055. This publication uses AS 4055 as these loads are in common use and suitable for class 1 and 10 structures. Additionally, we have included the actual wind load used so users of AS 1170 part 2 can reference the data for other classes of buildings. All wind loads are for importance level 2 buildings only.

All Stramit® products included in *The Stramit Book of Answers*® that require wind load performance have span or load tables that reference AS 4055.

For more information on wind loads, and the relevant rules, please refer to AS 4055-2012 (or AS 1170.2). This handbook has a simplified version to assist designers on the loads applicable to their structure.

Wind load classification

Determining the wind load classification is a 5 step process.

Step 1

Using the map below select the wind region where the structure is to be built.

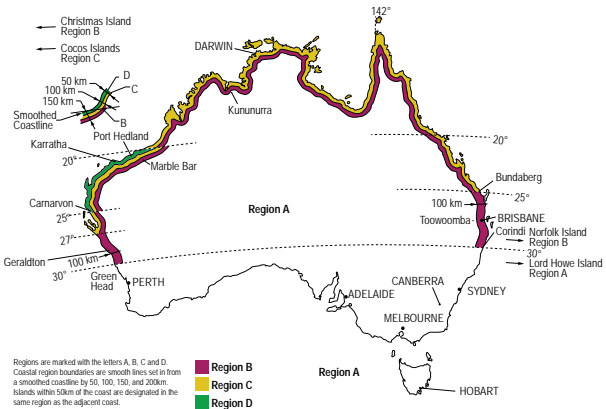

Reference: AS/NZS 4055 (modified)

Step 2

Determine the terrain category. Terrain categories are determined by the surface roughness in any direction from the building site for a distance of 500 metres. They are based on the likely terrain situation 5 years after design. Table 5.1 below explains the five terrain categories available.

Table 5.1 Terrain category

Terrain category	Description
TC1	Very open terrain with few or no obstructions
TC1.5	Open water surfaces with shoaling waves
TC2	Open grasslands with well scattered obstructions with heights from 1.5 to 5m
TC2.5	Developing outer suburban areas that are in transition between category TC2 and TC3
TC3	Numerous closely spaced house sized obstructions, usually 3 to 10m in height

Reference: AS 4055 Clause 2.3 (a); (b); (c); (d) and (e) paraphrased

Additionally, roads, rivers, lakes and canals less than 200m wide are included in TC3. Parks less than 250000m² are usually TC3. Building sites less than 200m from the boundaries of open areas larger than 250000m² and surrounded by suburban terrain, are considered to be the same as the open area itself.

Step 3

The topography relating to a site location is often the most difficult to determine and misunderstood. Unfortunately, the topographic factors can significantly increase the wind loads particularly if the structure is near the top of a hill or escarpment. It is suggested that mapping software such as Google Earth be used to determine the size and slope of any undulation around the building. The position of the structure and the slope and height of a hill, ridge or escarpment all effect the wind loads.

Generally use the areas L, M and T on the diagrams following corresponding to the third points on the rise. The bottom of a hill is defined as that area where the average slope is less than 1 in 20. Should the structure be built on the lower third of the hill then there will be little impact caused by topography.

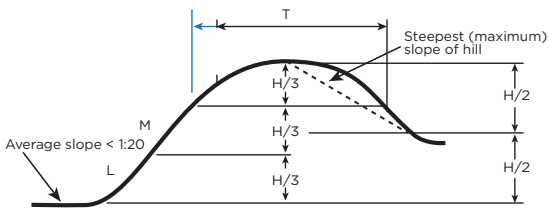

(a) Hills

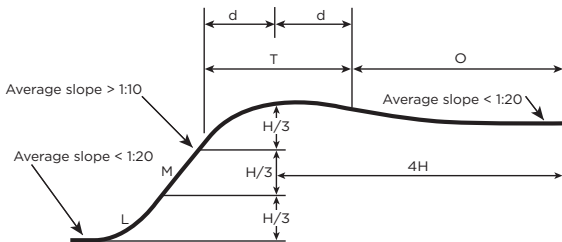

(b) Escarpments

LEGEND:

- H = height of the hill, ridge or escarpment
- d = average horizontal distance measured from the crest of the escarpment to the near top-third zone
- L = lower third of the hill, ridge or escarpment
- M = middle third of the hill, ridge or escarpment
- T = top third of the hill, ridge or escarpment
- O = overtop zone (for escarpment only)

Reference: AS 4055 Figure 2.2

As a guide,

- a) Firstly, determine the boundaries and height of the hill
- b) If the structure is in the bottom third of the hill, go to step f)
- c) Find the mid-point (in height) of the hill
- d) Above this point determine the steepest (maximum) slope to the hill crest
- e) Determine if the site is in the mid, or top third of the hill height
- f) Refer to table 5.2 to determine the relevant Topography classification

Table 5.2 Topographic classification for hills, ridges and escarpments

Maximum slope		Site location					Over top escarpment (O)
		Lower third (L)	Mid third (M)	Top third (T)			
				H < 10m	H = 10-30m	H > 30m	
<2.9°	<1:20	T0	T0	T0	T0	T0	T0
2.9° - 5.7°	1:20-1:10	T0	T0	T1	T1	T1	T0
5.7° - 7.6°	1:10 - 1:7.5	T0	T1	T1	T2	T2	T0
7.6° - 11.3°	1:7.5 - 1:5	T0	T1	T2	T2	T3	T1
11.3° - 18.4°	1:5 - 1:3	T0	T2	T2	T3	T4	T2
>18.4°	<1:3	T0	T2	T3	T4	T5	T3

Reference: AS 4055 Table 2.3 (modified)

Step 4

Determine the shielding class using table 5.3.

Table 5.3 Shielding class

Full shielding (FS)	<p>Only possible with topographic class T0, T1 and T2.</p> <p>At least 2 rows of similar sized houses surround the site.</p> <p>In Region A and B only, permanent, closely spaced trees higher than the considered structure and extending equivalent to three rows of houses.</p> <p>Roads and open spaces less than 100m in any direction can be ignored.</p>
Partial shielding (PS)	<p>In Region A and B only, permanent, closely spaced trees higher than the considered structure and extending equivalent to two rows of houses. Only possible with topographic class T0 to T3.</p> <p>The second row of houses adjacent to open parkland, open water or airfields.</p> <p>Acreage type suburbs.</p>
No shielding (NS)	<p>No permanent obstructions protect the site.</p> <p>The first row of houses adjacent to open parkland, open water or airfields.</p>

Reference: AS 4055 Clause 2.5 (a); (b) and (c) paraphrased

Step 5

Once the geographic region, the terrain category, topography and shielding classifications for the site are completed, use the following table to determine the actual wind classification. The simple wind levels of N1 to N6 for non-cyclonic and C1 to C4 for cyclonic areas are used throughout *The Stramit Book of Answers*® for all products subject to wind load.

Table 5.4 Wind classification

Wind region	Terrain category	Topographic class																							
		T0			T1			T2			T3			T4			T5								
		FS	PS	NS	FS	PS	NS	FS	PS	NS	FS	PS	NS	FS	PS	NS	FS	PS	NS						
A	3	N1	N1	N1	N1	N2	N2	N2	N2	N2	N2	N2	N2	N2	N2	N2	N2	N2	N2	N2					
	2.5	N1	N1	N2	N1	N2	N2	N2	N3	N2	N3	N3	N3	N3	N3	N3	N3	N3	N3	N3	N3				
	2	N1	N2	N2	N2	N2	N3	N2	N3	N2	N3	N3	N3	N3	N3	N3	N3	N3	N3	N3	N3	N3			
	1.5	N2	N2	N2	N2	N2	N3	N2	N3	N2	N3	N3	N3	N3	N3	N3	N3	N3	N3	N3	N3	N3			
	1	N2	N3	N3	N2	N3	N3	N2	N3	N2	N3	N3	N3	N3	N3	N3	N3	N3	N3	N3	N3	N3	N3		
B	3	N2	N2	N3	N2	N3	N2	N3	N3	N3	N3	N3	N3	N3	N3	N3	N3	N3	N3	N3	N3	N3	N3		
	2.5	N2	N3	N3	N3	N3	N3	N3	N3	N3	N3	N3	N3	N3	N3	N3	N3	N3	N3	N3	N3	N3	N3		
	2	N2	N3	N3	N3	N3	N3	N3	N3	N3	N3	N3	N3	N3	N3	N3	N3	N3	N3	N3	N3	N3	N3	N3	
	1.5	N3	N3	N4	N3	N4	N3	N4	N4	N3	N4	N4	N4	N4	N4	N4	N4	N4	N4	N4	N4	N4	N4	N4	
	1	N3	N4	N4	N4	N4	N4	N4	N4	N4	N4	N4	N4	N4	N4	N4	N4	N4	N4	N4	N4	N4	N4	N4	
C	3	C1	C1	C2	C1	C2	C1	C2	C2	C2	C2	C2	C2	C2	C2	C2	C2	C2	C2	C2	C2	C2	C2	C2	
	2.5	C1	C2	C2	C2	C2	C2	C2	C2	C2	C2	C2	C2	C2	C2	C2	C2	C2	C2	C2	C2	C2	C2	C2	
	2	C1	C2	C2	C2	C2	C2	C2	C2	C2	C2	C2	C2	C2	C2	C2	C2	C2	C2	C2	C2	C2	C2	C2	C2
	1.5	C2	C2	C3	C2	C3	C2	C3	C3	C3	C3	C3	C3	C3	C3	C3	C3	C3	C3	C3	C3	C3	C3	C3	C3
	1	C2	C3	C3	C3	C3	C3	C3	C3	C3	C3	C3	C3	C3	C3	C3	C3	C3	C3	C3	C3	C3	C3	C3	C3
D	3	C2	C3	C3	C2	C3	C3	C3	C3	C3	C3	C3	C3	C3	C3	C3	C3	C3	C3	C3	C3	C3	C3	C3	
	2.5	C2	C3	C3	C3	C3	C3	C3	C3	C3	C3	C3	C3	C3	C3	C3	C3	C3	C3	C3	C3	C3	C3	C3	
	2	C3	C3	C4	C3	C4	C3	C4	C4	C4	C4	C4	C4	C4	C4	C4	C4	C4	C4	C4	C4	C4	C4	C4	
	1.5	C3	C4	C4	C4	C4	C4	C4	C4	C4	C4	C4	C4	C4	C4	C4	C4	C4	C4	C4	C4	C4	C4	C4	
	1	C3	C4	C4	C4	C4	C4	C4	C4	C4	C4	C4	C4	C4	C4	C4	C4	C4	C4	C4	C4	C4	C4	C4	

Additional information

The following tables provide designers with additional wind speed and load information.

Table 5.5 Design gust wind speed (m/s)

Wind region	Wind category	Serviceability limit state	Strength limit state
A & B	N1	26	34
	N2	26	40
	N3	32	50
	N4	39	61
	N5	47	74
	N6	55	86
C & D	C1	32	50
	C2	39	61
	C3	47	74
	C4	55	86

Reference: AS 4055 Tables 2.1A and 2.1B compilation

Table 5.6 Wind load (kPa) for the wind load classification

Wind load category		Serviceability limit state			Strength limit state			
		General areas	Edge areas	Corner areas	General areas	Edge areas	Corner areas	
Walls	N1	-0.31	-0.55	-0.94	-0.53	-0.74	-1.30	
	N2	-0.31	-0.55	-0.94	-0.53	-0.74	-1.30	
	N3	-0.47	-0.83	-2.03	-1.16	-1.72	-3.01	
	N4	-0.70	-1.23	-3.01	-1.72	-2.53	-4.44	
	N5	-1.02	-1.79	-4.44	-2.53	-3.42	-5.99	
	N6	-1.40	-2.45	-5.99	-3.42	-1.80	-2.70	
	C1	-0.47	-0.83	-2.70	-1.80	-2.68	-4.02	
	C2	-0.70	-1.23	-4.02	-2.68	-3.94	-5.91	
	C3	-1.02	-1.79	-5.91	-3.94	-5.33	-7.99	
	C4	-1.40	-2.45	-7.99	-5.33	-0.69	-1.81	
	Roofs	N1	-0.40	-0.73	-1.81	-0.69	-1.25	-2.51
		N2	-0.40	-0.73	-1.81	-0.95	-1.73	-3.92
N3		-0.61	-1.11	-3.92	-1.49	-2.70	-5.83	
N4		-0.90	-1.64	-5.83	-2.21	-4.02	-8.58	
N5		-1.31	-2.39	-8.58	-3.25	-5.91	-11.58	
N6		-1.80	-3.27	-11.58	-4.39	-7.99	-4.59	
C1		-0.61	-1.11	-4.59	-2.16	-3.38	-6.83	
C2		-0.90	-1.64	-6.83	-3.21	-5.02	-10.05	
C3		-1.31	-2.39	-10.05	-4.73	-7.39	-13.58	
C4		-1.80	-3.27	-13.58	-6.39	-9.98		

Reference: AS 4055 Tables 3.3 and 3.4 compilation

Shaded columns are used in the product span charts to determine the maximum span for that profile.

Negative numbers are due to suction wind loads.

AS 4055 limitations

Please refer to AS 4055 for limitations on the use of this domestic house (class 1) and shed (class 10) wind code.

General limitations are a maximum average roof height of 6.5m and roof pitches below 35 degrees.

Summary Checklist

- ✓ *The Stramit Book of Answers*[®] uses AS 4055 and is suitable for Class 1 and 10 buildings only.
- ✓ Determine the appropriate factors for terrain category, topography and shielding classifications to suit the structure location.
- ✓ For other structures and designs using AS 1170 part 2, select a wind category with an equal or higher wind pressure using table 5.6.

Notes:

6. A complete steel building product solution

Whatever your steel roofing, rainwater or structural product need, we've got you covered.

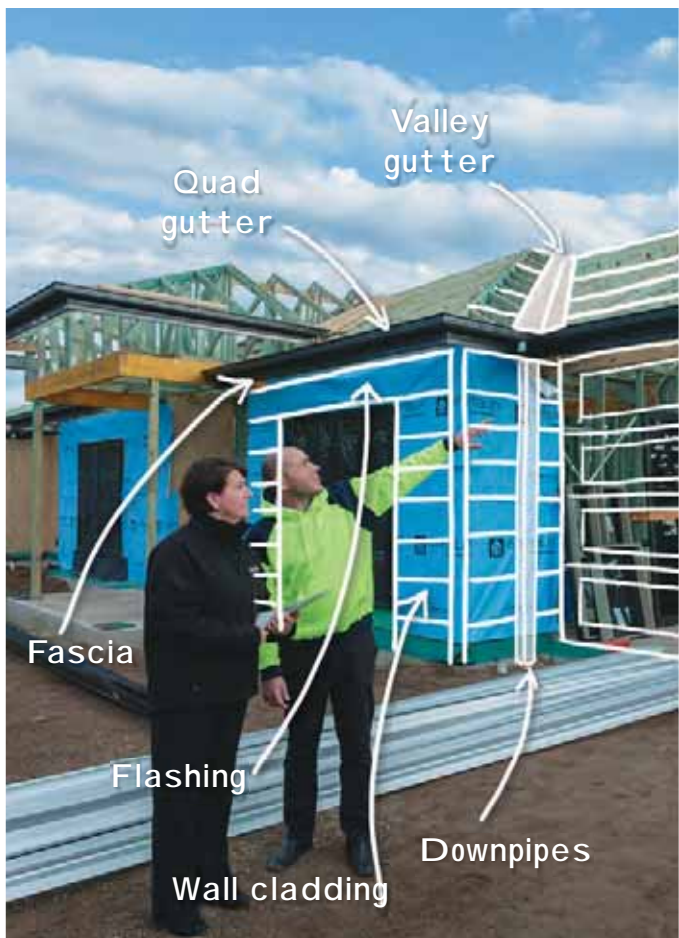

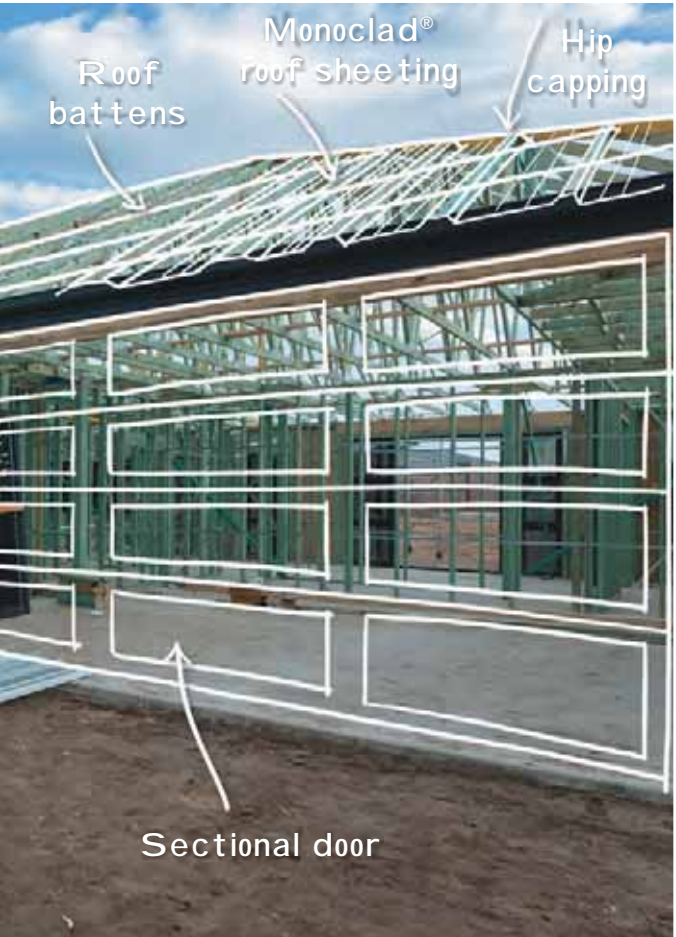

Notes:



7. Roofing and Wall Cladding to suit any Aussie building

STRAMIT'S GOT YOU COVERED WITH ROOFING AND WALL CLADDING FOR ANY ARCHITECTURAL STYLE OR APPLICATION

We manufacture a wide range of profiles to suit all types of projects, from houses and home improvements through to large-scale commercial and industrial developments. Most Stramit® profiles can be used in flat, pitched or curved roof applications, and while roof profiles are often used in wall applications, wall cladding is not suitable for roofing.

Our profiles can vary in thickness, fastener frequency and batten type, all of which affects the cladding span and results in significant differences in product performance. There is no right or wrong answer, as the variables all impact the final economic solution.

As a general rule, use thicker supports to obtain the most performance, and variable fastener patterns to cater for local pressure zones in corners. The data in *The Stramit Book of Answers*® is always presented in the same way, with all cladding, purlin and top hat tables reflecting the cladding span to suit a particular wind load. This allows for easy design by providing similar answers regardless of the selected profile.

Stramit also produces two specialist products from these profiles. The Stramit® acoustic wall system allows designers to create aesthetically pleasing walls that absorb sound, and the Uniguard™ fire resisting wall system can be used on some buildings where boundary conditions require fire protection.

For further information please refer to the relevant Stramit® product technical manual or contact your local technical services consultant.

Performance

The cladding performance data used in this Roofing and Wall Cladding section has been produced at Stramit's in-house research and development facility in Sydney. All profile load tables are the result of testing on specially designed roof testing rigs, with profiles tested multiple times to obtain statistical performance data.

The tables reflect the performance in the Ultimate and Serviceability Limit States as well as the foot traffic limit for roofing cladding. All tests have been undertaken in accordance with AS 1562 and AS 4040 and the tables reflect the wind load categories from AS 4055 for both non-cyclonic (N1 to N6) and cyclonic (C1 to C4) regions.

Cyclonic areas have their own testing criteria that create a different wind load table for Stramit® cladding profiles. This fatigue inducing test requires the application of repeated loads in a particular sequence. This low-high-low testing procedure is conducted on purpose-built testing equipment at the Stramit research and development facility.

For more information on the use of Stramit® profiles in Darwin, please refer to the *Darwin Area Building Manual* data sheets for the profile selected.

Limit states

At the Serviceability Limit State wind load, all Stramit® cladding meets the deflection criteria and serviceability requirements. At the Strength Limit State, the profile remains in place although some buckling may have occurred to the product. Both Limit States have been used in the design tables, with the lower performance selected.

Please note that serviceability deflection criteria has been relaxed for the SharpLine® series of roof and wall cladding, and Sunset roof cladding.

Foot traffic

All Stramit® roof profiles have recommended span limits to allow for foot traffic across the roof, which we define as roof maintenance and occasional traffic (refer to AS 1170.1 for details on R2 - Other Roofs). Care must be taken when walking across the profile to place feet in the profile trays (or pans)—or in the case of multi-ribbed profiles, across two ribs—to prevent roof damage.

Where applicable, and if controlling, the foot traffic limit has been used in the product performance table. For more information please refer to the Stramit® *Foot Traffic Guide*.

Thermal expansion

All metal roof sheeting will expand and contract due to the heat radiated from the sun. Roof temperatures can rise up to three times the ambient temperature depending upon the roof colour. This temperature variation causes the roof to expand. Stramit has recommended length limitations to prevent permanent damage to the roof sheeting and fasteners. Curved roofs have less ability to resist the expansion without problems.

Concealed fixed roof decking has been designed to accommodate the expansion and therefore allows longer lengths to be used.

Table 7.1 Thermal expansion

Maximum sheet length (m)						
Roof type	Through fixed		Concealed fixed			
Roof colour	Light	Dark	Light		Dark	
			SDU	SD500	SDU	SD500
Flat	25	17	42	35	30	25
Spring curved	20	17	30	30	20	20

Span types

The structural performance of a roof/wall sheet system is affected by the span configuration. Like all structural products the span type will change the amount of stress within the sheeting and deflection in the individual spans. For simplicity, Stramit has produced span charts with a small variety of span types to allow designers to choose the type that best matches their project. For best economy Stramit will always recommend the reduced end span system. We do not supply single span data as the size and type of support affects the cladding performance significantly.

Double spans



Double spans are two spans with the same length in each span. For double span performance tables please refer to the Stramit® product technical manual for the selected product. Alternatively, for convenience, a conservative double span value can be calculated by deducting 15% from the value of an equal span system.

Equal spans



Equal spans are the common span type used across Australia where all spans along the cladding run are the same length and there is a minimum of 3 spans.

Internal/end spans

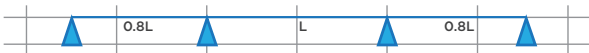

Internal/end spans are the preferred span arrangement to produce the lowest cost cladding structure. Internal spans can be increased slightly, and end spans are always at 80% of the internal span. This arrangement reduces stress and deflection in the end span which would normally dictate the design. In this arrangement, there is a minimum 3-span requirement (with a single internal span with an end span on either side).

Please note that other ratios of internal/end spans do not comply with the data contained in this book.

Fasteners

All fasteners used with Stramit® cladding must conform to AS 3566. Class 4 screws are recommended to ensure adequate life performance of the fastener and cladding. All the span charts in this book include a fastener recommendation to suit the thickness of the supporting batten or purlin. The pressure of thick insulation and/or softwood battens may require longer screws.

Batten or purlin

The thickness of the supporting batten or purlin can have a significant effect on the performance of the cladding system. Generally, a thicker support gives better performance. The cladding performance tables reflect the variation caused by the support thickness so designers can determine the most appropriate design solution.

Roof slope

The roof slope can have a significant effect on building cost. Lower roof pitches save building height and some vertical cladding costs. However, a higher pitch (above 5 degrees) improves roof drainage, wind resistance, and can lead to self-cleaning, more durable roofs free of debris. Increased roof pitch does require more care to be taken by tradespeople walking on the roof, and steeper pitches may require the use of ladders and safety harnesses to gain access.

The following slope/roof run tables are based on a rainfall intensity of a 100-year ARI (Average Recurrence Interval) of 5 minutes duration. Rainfall intensities used in the calculations are derived from the National Construction Code Volume 2 and the Bureau of Meteorology website. We define the roof run length as the combined length of roofing run contributing to water flow in any one sheeting pan (or trough) at the lowest edge.

Please refer to the Stramit *Roof Slope Design Guide* for more details, particularly if roof penetrations are present. The table lists locations throughout each state and territory and products highlighted in red are at their minimum pitch recommendations.

Roof slope drainage

QUEENSLAND AND NORTHERN TERRITORY

Table 7.2 Roof run (m) at roof slope (pitch) shown

Roof slope (deg)		1			1.5		2		
Northern Territory and Queensland	Locality	Rainfall intensity (mm/hr)	Speed Deck Ultra®	CapacityPLUS™660	Speed Deck Ultra®	CapacityPLUS™660	Speed Deck Ultra®	CapacityPLUS™660	Monoclad®
	Northern Territory	Darwin	274	105	>150	120	>150	133	>150
Katherine		250	116	>150	132	>150	146	>150	88
Alice Springs		239	121	>150	138	>150	>150	>150	92
Far North Queensland	Cairns	278	104	>150	118	>150	131	>150	79
	Innisfail	301	96	>150	109	>150	121	>150	73
	Townsville	300	96	>150	110	>150	121	>150	73
	Charters Towers	250	116	>150	132	>150	146	>150	88
North West Queensland	Cloncurry	278	104	>150	118	>150	131	>150	79
	Mt Isa	260	111	>150	127	>150	140	>150	84
Central Queensland	Proserpine	293	99	>150	112	>150	124	>150	75
	Mackay	316	91	145	104	>150	115	>150	69
	Rockhampton	300	96	>150	110	>150	121	>150	73
	Longreach	251	115	>150	131	>150	145	>150	87
South East Queensland	Bundaberg	340	85	134	97	>150	107	>150	64
	Gympie	278	104	>150	118	>150	131	>150	79
	Noosa Heads	331	87	138	99	>150	110	>150	66
	Brisbane	305	95	>150	108	>150	119	>150	72
	Southport	335	86	136	98	>150	109	>150	65
South West Queensland	Toowoomba	268	108	>150	123	>150	136	>150	82
	Warwick	252	115	>150	131	>150	144	>150	87
	Goondiwindi	258	112	>150	128	>150	141	>150	85
	Charleville	238	122	>150	138	>150	>150	>150	92



	3					4					5					
	Speed Deck Ultra®	CapacityPLUS™660	Monoclad®	Stramit Longspan®	SharpLine®	Speed Deck Ultra®	CapacityPLUS™660	Monoclad®	Stramit Longspan®	SharpLine®	Speed Deck Ultra®	CapacityPLUS™660	Monoclad®	Stramit Longspan®	SharpLine®	Corrugated
	>150	>150	93	23	57	>150	>150	104	25	64	>150	>150	114	27	70	15
	>150	>150	102	25	63	>150	>150	114	28	70	>150	>150	125	30	77	16
	>150	>150	107	26	65	>150	>150	119	29	73	>150	>150	131	32	80	17
	>150	>150	92	23	56	>150	>150	103	25	63	>150	>150	112	27	69	15
	140	>150	85	21	52	>150	>150	95	23	58	>150	>150	104	25	64	13
	141	>150	85	21	52	>150	>150	95	23	58	>150	>150	104	25	64	13
	>150	>150	102	25	63	>150	>150	114	28	70	>150	>150	125	30	77	16
	>150	>150	92	23	56	>150	>150	103	25	63	>150	>150	112	27	69	15
	>150	>150	98	24	60	>150	>150	110	27	67	>150	>150	120	29	74	16
	144	>150	87	22	53	>150	>150	97	24	60	>150	>150	107	26	65	14
	134	>150	80	20	49	>150	>150	90	22	55	>150	>150	99	24	61	13
	141	>150	85	21	52	>150	>150	95	23	58	>150	>150	104	25	64	13
	>150	>150	101	25	62	>150	>150	114	28	70	>150	>150	125	30	76	16
	124	>150	75	18	46	139	>150	84	20	51	>150	>150	92	22	56	12
	>150	>150	92	23	56	>150	>150	103	25	63	>150	>150	112	27	69	15
	128	>150	77	19	47	143	>150	86	21	53	>150	>150	94	23	58	12
	139	>150	83	21	51	>150	>150	93	23	57	>150	>150	102	25	63	13
	126	>150	76	19	47	141	>150	85	21	52	>150	>150	93	22	57	12
	>150	>150	95	24	58	>150	>150	106	26	65	>150	>150	117	28	72	15
	>150	>150	101	25	62	>150	>150	113	28	69	>150	>150	124	30	76	16
	>150	>150	99	24	61	>150	>150	111	27	68	>150	>150	121	29	74	16
	>150	>150	107	27	66	>150	>150	120	29	74	>150	>150	131	32	81	17

Roof slope drainage

NEW SOUTH WALES AND ACT

Table 7.3 Roof run (m) at roof slope (pitch) shown

Roof slope (deg)			1		1.5		2		
New South Wales and ACT	Locality	Rainfall intensity (mm/hr)	Speed Deck Ultra®	CapacityPLUS™660	Speed Deck Ultra®	CapacityPLUS™660	Speed Deck Ultra®	CapacityPLUS™660	Monoclad®
	North Coast NSW	Lismore	270	107	>150	122	>150	135	>150
Coffs Harbour		382	76	120	86	136	95	>150	57
Kempsey		287	101	>150	115	>150	127	>150	76
Port Macquarie		313	92	146	105	>150	116	>150	70
Armidale		238	122	>150	138	>150	>150	>150	92
Central Coast NSW	Maitland	266	109	>150	124	>150	137	>150	82
	Newcastle	316	91	145	104	>150	115	>150	69
	Gosford	313	92	146	105	>150	116	>150	70
	Wyong	320	90	143	103	>150	114	>150	68
	Sydney	262	110	>150	126	>150	139	>150	84
	Parramatta	209	138	>150	>150	>150	>150	>150	105
	Riverstone	234	124	>150	141	>150	>150	>150	94
	Penrith	244	119	>150	135	>150	149	>150	90
Western Slopes NSW	Lithgow	196	148	>150	>150	>150	>150	>150	112
	Bathurst	164	>150	>150	>150	>150	>150	>150	134
	Orange	186	>150	>150	>150	>150	>150	>150	118
	Cowra	190	>150	>150	>150	>150	>150	>150	115
	Dubbo	222	130	>150	148	>150	>150	>150	99
	Forbes	205	141	>150	>150	>150	>150	>150	107
Southern Highlands NSW	Bowral	220	132	>150	>150	>150	>150	>150	100
	Mittagong	222	130	>150	148	>150	>150	>150	99
	Goulburn	156	>150	>150	>150	>150	>150	>150	141
South Coast NSW	Wollongong	308	94	148	107	>150	118	>150	71
	Nowra	247	117	>150	133	>150	147	>150	89
	Batemans Bay	268	108	>150	123	>150	136	>150	82
South West NSW/ACT	Canberra	193	>150	>150	>150	>150	>150	>150	114
	Wagga Wagga	208	139	>150	>150	>150	>150	>150	105
	Albury	180	>150	>150	>150	>150	>150	>150	122
	Broken Hill	219	132	>150	>150	>150	>150	>150	100



	3					4					5					
	Speed Deck Ultra®	CapacityPLUS™660	Monoclad®	Stramit Longspan®	SharpLine®	Speed Deck Ultra®	CapacityPLUS™660	Monoclad®	Stramit Longspan®	SharpLine®	Speed Deck Ultra®	CapacityPLUS™660	Monoclad®	Stramit Longspan®	SharpLine®	Corrugated
	>150	>150	94	23	58	>150	>150	106	26	65	>150	>150	116	28	71	15
	111	>150	66	16	41	124	>150	75	18	46	136	>150	82	20	50	10
	147	>150	89	22	54	>150	>150	99	24	61	>150	>150	109	26	67	14
	135	>150	81	20	50	>150	>150	91	22	56	>150	>150	100	24	61	13
	>150	>150	107	27	66	>150	>150	120	29	74	>150	>150	131	32	81	17
	>150	>150	96	24	59	>150	>150	107	26	66	>150	>150	118	28	72	15
	134	>150	80	20	49	>150	>150	90	22	55	>150	>150	99	24	61	13
	135	>150	81	20	50	>150	>150	91	22	56	>150	>150	100	24	61	13
	132	>150	79	20	49	148	>150	89	22	55	>150	>150	98	23	60	13
	>150	>150	97	24	60	>150	>150	109	27	67	>150	>150	119	29	73	15
	>150	>150	122	30	75	>150	>150	137	33	84	>150	>150	>150	36	92	20
	>150	>150	109	27	67	>150	>150	122	30	75	>150	>150	134	32	82	17
	>150	>150	104	26	64	>150	>150	117	29	72	>150	>150	128	31	79	17
	>150	>150	130	32	80	>150	>150	146	36	89	>150	>150	>150	39	98	21
	>150	>150	>150	39	95	>150	>150	>150	43	107	>150	>150	>150	46	117	25
	>150	>150	137	34	84	>150	>150	>150	38	94	>150	>150	>150	41	103	22
	>150	>150	134	33	82	>150	>150	>150	37	92	>150	>150	>150	40	101	22
	>150	>150	115	29	70	>150	>150	129	31	79	>150	>150	141	34	86	18
	>150	>150	124	31	76	>150	>150	139	34	85	>150	>150	>150	37	94	20
	>150	>150	116	29	71	>150	>150	130	32	80	>150	>150	142	34	87	19
	>150	>150	115	29	70	>150	>150	129	31	79	>150	>150	141	34	86	18
	>150	>150	>150	41	100	>150	>150	>150	45	112	>150	>150	>150	49	123	26
	137	>150	83	20	51	>150	>150	93	23	57	>150	>150	101	24	62	13
	>150	>150	103	26	63	>150	>150	116	28	71	>150	>150	127	30	78	16
	>150	>150	95	24	58	>150	>150	106	26	65	>150	>150	117	28	72	15
	>150	>150	132	33	81	>150	>150	148	36	91	>150	>150	>150	39	99	21
	>150	>150	123	31	75	>150	>150	137	34	84	>150	>150	>150	36	92	20
	>150	>150	142	35	87	>150	>150	>150	39	97	>150	>150	>150	42	107	23
	>150	>150	116	29	71	>150	>150	130	32	80	>150	>150	143	34	88	19

Roof slope drainage

VICTORIA, TASMANIA AND SOUTH AUSTRALIA

Table 7.4 Roof run (m) at roof slope (pitch) shown

Roof slope (deg)			1		1.5		2		
Victoria, Tasmania and South Australia	Locality	Rainfall intensity (mm/hr)	Speed Deck Ultra®		Speed Deck Ultra®		Speed Deck Ultra®		
			Stramit Speed Deck® 500		Stramit Speed Deck® 500		Stramit Speed Deck® 500		Monoclad®
Victoria	Mildura	218	133		>150		>150		101
	Stawell	186	>150		>150		>150		118
	Ballarat	188	>150		>150		>150		117
	Melbourne	187	>150		>150		>150		117
	Geelong	144	>150		>150		>150		>150
	Lakes Entrance	198	146		>150		>150		111
Tasmania	Launceston	121	>150	>150	>150	>150	>150	>150	>150
	Burnie	180	>150	136	>150	>150	>150	>150	122
	Hobart	116	>150	>150	>150	>150	>150	>150	>150
South Australia	Port Augusta	199	145		>150		>150		110
	Adelaide	184	>150		>150		>150		119
	Mt Gambier	144	>150		>150		>150		>150

Roof slope drainage

WESTERN AUSTRALIA

Table 7.5 Roof run (m) at roof slope (pitch) shown

Roof slope (deg)			1		1.5		2		
Western Australia	Locality	Rainfall intensity (mm/hr)	Speed Deck Ultra®		Speed Deck Ultra®		Speed Deck Ultra®		Monoclad®
North Coast WA	Broome	287	101		115		127		76
	Port Hedland	230	126		143		>150		95
	Geraldton	193	>150		>150		>150		114
South West WA	Perth	172	>150		>150		>150		128
	Bunbury	199	145		>150		>150		110
	Albany	178	>150		>150		>150		123



	3					4					5					
	Speed Deck Ultra®	Stramit Speed Deck® 500	Monoclad®	Stramit Longspan®	SharpLine®	Speed Deck Ultra®	Stramit Speed Deck® 500	Monoclad®	Stramit Longspan®	SharpLine®	Speed Deck Ultra®	Stramit Speed Deck® 500	Monoclad®	Stramit Longspan®	SharpLine®	Corrugated
	>150		117	29	72	>150		131	32	80	>150		144	35	88	19
	>150		137	34	84	>150		>150	38	94	>150		>150	41	103	22
	>150		136	34	83	>150		>150	37	93	>150		>150	40	102	22
	>150		136	34	84	>150		>150	37	94	>150		>150	40	103	22
	>150		>150	44	109	>150		>150	49	122	>150		>150	53	133	29
	>150		129	32	79	>150		144	35	88	>150		>150	38	97	21
	>150	>150	>150	53	129	>150	>150	>150	58	145	>150	>150	>150	63	>150	34
	>150	>150	142	35	87	>150	>150	>150	39	97	>150	>150	>150	42	107	23
	>150	>150	>150	55	135	>150	>150	>150	61	>150	>150	>150	>150	65	>150	36
	>150		128	32	79	>150		144	35	88	>150		>150	38	96	21
	>150		139	35	85	>150		>150	38	95	>150		>150	41	104	22
	>150		>150	44	109	>150		>150	49	122	>150		>150	53	133	29



	3				4				5				
	Speed Deck Ultra®	Monoclad®	Stramit Longspan®	SharpLine®	Speed Deck Ultra®	Monoclad®	Stramit Longspan®	SharpLine®	Speed Deck Ultra®	Monoclad®	Stramit Longspan®	SharpLine®	Corrugated
	147	89	22	54	>150	99	24	61	>150	109	26	67	14
	>150	111	28	68	>150	124	30	76	>150	136	33	83	18
	>150	132	33	81	>150	148	36	91	>150	>150	39	99	21
	>150	148	37	91	>150	>150	41	102	>150	>150	44	112	24
	>150	128	32	79	>150	144	35	88	>150	>150	38	96	21
	>150	143	36	88	>150	>150	39	98	>150	>150	42	108	23

Spring curving

Stramit® cladding can be spring curved, concave or convex, including curved ridges, provided it is sealed at the apex, and within the following limitations.

Table 7.6 Spring curving limitations*

Profile	Thickness	Minimum radius (m)	Max int. span at min rad. (mm)	Min radius for normal spans	Max radius due to water capacity	Roof crest sealed distance (m)
Corrugated	0.42	12	900	25	37	3.3
	0.48	10	900	25	37	3.3
	0.60	8	900	26	37	3.3
Stramit Longspan®	0.42	30	1200	88	78	2.1
	0.48	20	1200	113	78	2.1
Monoclad®	0.42	70	1200	132	105	3.7
	0.48	60	1200	132	105	3.7
Stramit Speed Deck® 500	0.42	70	1200	198	210	3.7
	0.48	50	1200	159	210	3.7
Speed Deck Ultra®	0.42	90	1200	99	225	4.0
	0.48	70	1200	99	225	4.0
Capacity PLUS™660	0.42	90	1200	100	225	4.0
	0.48	70	1200	100	225	4.0

* At rainfall intensity of 370mm/hr

Notes: The minimum radius above has been determined to ensure serviceability of the profile, and, in the case of tray type profiles, to limit the amount of tray buckle to acceptable limits. At all radii below the 'normal span' radius above, purlin spacing should be reduced as shown to ensure a smooth curve. At very large radii, at the top of the curve where the minimum roof pitch is not met, the sheet sidelaps should be sealed to prevent water entry. The values above for the sealed distance are to be applied on either side of the theoretical ridge.

Impact

For wall areas likely to be subject to human impact, cladding spans should be reduced. Impact loads will vary considerably and these are not prescribed in Australian Standards. A span of 900mm is suggested for such areas, but this should be adjusted dependent upon the exposure, the profile selected, and the importance of the application.

Cladding load tables

Each Stramit® roof or wall profile in this book has its own span table. The tables include allowance for different batten types and thicknesses. Batten selection is important as thicker battens create more fastener load resistance and therefore longer product spans. All wind load categories for both roofs and walls from AS 4055 are provided. There are tables for different numbers of fasteners, where appropriate, and for equal and reduced end span systems. The required fastener type is given at the top of each table.

Please note that no design data is provided for the capacity of timber battens. Metal battens, top hats and purlin tables can be found in subsequent sections of *The Stramit Book of Answers*®.

How to use the roofing and wall cladding load tables

1. Determine the required wind load category using:

- The wind load section of this publication on page 30, or
- AS 4055 to obtain a more comprehensive answer for Class 1 or 10 buildings, or
- AS/NZ 1170 part 2 to determine the required wind pressure, and then refer to the pressure table (table 5.6) on page 35, and select a wind load category that matches or exceeds that wind pressure.

2. Consider how the roof or wall cladding performance will be impacted by the following variables:

- Batten or purlin thickness
- Preferred cladding profile
- Fastener frequency (if available)
- Profile thickness
- The difference between cyclonic and non-cyclonic test results

The slight variations that occur between competitor products affect performance so the span tables provided in this book only apply to Stramit® products. Designers can start with the wind load category, and with any of the above variables, then continue to refine the design parameters until all options have been considered.

3. Use the tables to determine the maximum span for both an internal/end span combination, or an equal span solution.

The internal/end span arrangement, with the end span always set at 80% of the internal span, is usually the most economical solution. With the span solution in mind, the designer can move on to Step 4, or alternatively repeat Step 2 using different variables to obtain different results.

The final solution may be determined by the designer's understanding of the cost effectiveness of a cladding system that includes an appreciation of cladding span, batten details and fastener installation costs.

4. Calculate the actual spans to suit the actual roof sheet run length using either the combination or equal span limitations.

All spans in this book are maximum spans. In practice the cladding run length is set by the limitations on structure size or height. Normally designers calculate the actual sheet length or run, and then divide by the maximum span to determine the number of spans. The actual span is usually lower than the maximum span.

Hint: to calculate the internal span of a reduced end span use the following steps:

- Divide the run length by the maximum internal span.
- If the fraction remaining is greater than 0.6, round the number up to the next whole figure, otherwise round down to the integer value.
- Add 0.6, then divide the actual run length by this new number.
- This will give you the internal span, and multiply this by 0.8, and you will get the end span value.
- Rounding of the values to the nearest 10mm is allowed.

5. Review the spans and determine the roof corner area design.

The roof spans given in the tables allow for the building edge wind pressure as determined in AS 4055. For corner areas, and only for roof pitches less than 10 degrees, designers can add an intermediate batten between the first and second battens at each end of the roof. This batten would be at least 1200mm in length, and the roof cladding would be attached using the nominated fasteners. Alternatively, it may be possible after referencing the wind load table 5.6 in chapter 5 to select a higher wind load category and compare the actual roof span against the maximum allowable for the higher load. This often allows the original span to be maintained without any additional battens.

As wall claddings have already been designed with corner pressures in mind, no additional work is required. However, designers should refer to AS 4055 for more detail should the building aspect ratio exceed 1.

Please refer to chapter 17 for a worked example on how to use the roofing and wall cladding tables.

Summary Checklist

- ✓ Use the table for the required batten/purlin thickness.
- ✓ Check different thickness claddings to obtain the best performance fit
- ✓ Utilise different fastener frequencies to obtain the best economic fit
- ✓ Always use the correct fastener specification given at the top of each table
- ✓ Reduce the number of battens/purlins by using the internal/end span combination
- ✓ Compare different profiles to gain the product advantage
- ✓ For more information go to stramit.com.au/products/

Table 7.7 Cladding profile dimensions

Profile	Rib height (mm)	Cover width (mm)	Rib spacing (mm)
Corrugated	16	762	76.2
Monoclad®	29	762	190
Stramit Longspan®	27	700	100
CapacityPLUS™660	50	660	220
Speed Deck Ultra®	43	700	233
Stramit Speed Deck® 500	41	500	250
SharpLine® Direct	25	290	290
	25	490	490
	38	265	265
	38	465	465
SharpLine® Clip	25	320	320
	25	520	520
	38	285	285
	38	485	485
K Panel®	12	864	216
Monoclad® wall	29	762	190
Mini Corry®	6	825	25
Stramit Minirib®	4	900	60
Monopanel®	12.5	250	100
C-Clad 280	15	280	120
Premier 300™	15	300	125
Sunset® Patio	43	290	290

ROOF AND WALL CLADDING PROFILES



Corrugated Roof and Wall Cladding



Monoclad® Roof and Wall Cladding



Stramit Longspan® Roof and Wall Cladding



CapacityPLUS™660 Deep Roof Cladding



Speed Deck Ultra® Concealed Fixed Decking



Stramit Speed Deck® 500 Concealed Fixed Decking

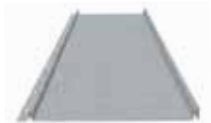

SharpLine® Direct



SharpLine® Clip

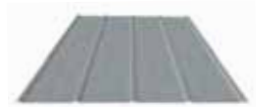

K-Panel® Wall Sheeting



Monoclad® Wall Sheeting



Mini Corry® Panelling



Stramit Minirib® Panelling



Monopanel®
Wall Cladding



C-Clad 280
Wall Sheeting



Premier 300™
Architectural Cladding

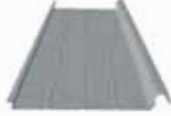

Sunset® Patio Panel



Uniguard™ Fire Resisting
Wall System

Notes:

Corrugated



Stramit's Corrugated roof and wall cladding is a traditional roofing profile enhanced by modern materials and finishes.

- Lightweight and easy to handle
- Cost-effective to use and quick to install
- Uses conventional through-fixed screws
- Available in an extensive range of colours

Mass

Table 7.8 Sheetting mass (kg/m² of area)

BMT (mm)	Grade	ZINCALUME® steel	COLORBOND® steel*	Galvanised
0.42	550MPa	4.28	4.35	4.65
0.48	550MPa	4.86	4.93	5.23
0.60	300MPa	6.02	6.09	6.39

For more details on Corrugated cladding, please refer to the Stramit Corrugated technical manual.

Minimum roof slope

Stramit's Corrugated roof and wall cladding can be used to a minimum 5-degree roof pitch (1 in 12). Please refer to tables 7.2 to 7.5 for roof slope limitations.

**The above values relate to COLORBOND® steel only and may be different for COLORBOND® Ultra steel, COLORBOND® Metallic steel and SUPERDURA™ Stainless steel.*



AVAILABLE



NOT AVAILABLE



Overhangs

The maximum overhang limits for both free edge and stiffened overhangs are shown below. An overhang is defined as the sheet projection past the last row of fasteners and has a minimum value of 50mm. Stiffened overhangs require attachment of an angle or gutter to prevent flexing of the sheet edge.

Table 7.9 Maximum overhang

BMT (mm)	Non-cyclonic		Cyclonic	
	Free edge	Stiffened	Free edge	Stiffened
0.42	100	250	100	250
0.48	100	300	100	300
0.6	100	250	100	250

But in all cases limited to:

- Free edge: to 20% of the back (adjacent end) span
- Stiffened by gutter or angles: to 33% of the back (adjacent end) span

Fastener locations

Corrugated cladding can be fixed with either 3 or 5 fasteners per sheet at each batten/purlin to meet the required performance values, as shown below:

Crest fastener locations



5 fasteners per sheet



3 fasteners per sheet

For roof spans exceeding 900mm and wall spans exceeding 1200mm, stitch the side laps at midspan.

Valley fastener location (walls only)



5 fasteners per sheet



3 fasteners per sheet

Accessories

Stramit can supply matching accessories for this profile including flashings, roll top ridges, barges, fasteners and translucent sheet in either polycarbonate or fibreglass.

Performance

The maximum span to suit the design variables can be determined from the following tables. For more information please refer to the How to use the roofing and wall cladding load tables section on page 53. Walls may be subject to impact loads, please refer to page 52 for recommendations.

Please note that Corrugated performance depends upon the batten or purlin used and the fastener specified at the top of each table.

Table 7.10 Stramit Corrugated on 0.48mm batten

Maximum span (mm)

Fasteners:

Roof: 12 x 50mm hex head Type 17 screws with neoprene washers or M6x50mm hex head Zip screws with neoprene washer

Wall: 10 x 25mm hex head Type 17 screws with neoprene washers or M6x25mm hex head Zip screws with neoprene washer

Number of fasteners

3/sheet

Cladding thickness		0.42mm BMT			0.48mm BMT			0.60mm BMT		
Span type		Internal	End	Equal	Internal	End	Equal	Internal	End	Equal
Roof	Wind load									
	N1	1300	900	900	1800	1400	1400	1900	1500	1500
	N2	1300	900	900	1500	1200	1350	1500	1200	1350
	N3	950	750	850	950	750	850	950	750	850
	N4	650	500	550	650	500	550	650	500	550
	N5									
	N6									
Wall	Wind load									
	N1	1950	1550	1750	1950	1550	1750	1950	1550	1750
	N2	1400	1100	1250	1400	1100	1250	1400	1100	1250
	N3	900	700	800	900	700	800	900	700	800
	N4	600	450	500	600	450	500	600	450	500
	N5									
	N6									

Number of fasteners

5/sheet

Cladding thickness		0.42mm BMT			0.48mm BMT			0.60mm BMT		
Span type		Internal	End	Equal	Internal	End	Equal	Internal	End	Equal
Roof	Wind load									
	N1	1300	900	900	1800	1400	1400	1900	1500	1500
	N2	1300	900	900	1800	1400	1400	1900	1500	1500
	N3	1300	900	900	1700	1350	1400	1700	1350	1500
	N4	1100	850	900	1100	850	950	1100	850	950
	N5	800	600	700	800	600	700	800	600	700
	N6	550	400	450	550	400	450	550	400	450
Wall	Wind load									
	N1	2600	2050	2150	2850	2250	2350	3000	2400	2600
	N2	2500	2000	2150	2500	2000	2250	2500	2000	2250
	N3	1600	1250	1400	1600	1250	1400	1600	1250	1400
	N4	1050	800	900	1050	800	900	1050	800	900
	N5	700	550	600	700	550	600	700	550	600
	N6	500	400	450	500	400	450	500	400	450



Table 7.11 Stramit Corrugated on 0.55mm batten

NON
CYCLONIC
AREAS 

Maximum span (mm)

Fasteners:

Roof: 12 x 50mm hex head Type 17 screws with neoprene washers

or M6x50mm hex head Zip screws with neoprene washer

Wall: 10 x 25mm hex head Type 17 screws with neoprene washers

or M6x25mm hex head Zip screws with neoprene washer

Number of fasteners

3/sheet

Cladding thickness		0.42mm BMT			0.48mm BMT			0.60mm BMT		
Span type		Internal	End	Equal	Internal	End	Equal	Internal	End	Equal
Roof	Wind load									
	N1	1300	900	900	1800	1400	1400	1900	1500	1500
	N2	1300	900	900	1700	1350	1400	1700	1350	1500
	N3	1100	850	900	1100	850	950	1100	850	950
	N4	700	550	600	700	550	600	700	550	600
	N5	500	400		500	400	450	500	400	450
	N6									
Wall	Wind load									
	N1	2350	1850	2100	2350	1850	2100	2350	1850	2100
	N2	1700	1350	1500	1700	1350	1500	1700	1350	1500
	N3	1100	850	950	1100	850	950	1100	850	950
	N4	700	550	600	700	550	600	700	550	600
	N5	500	400	450	500	400	450	500	400	450
	N6									

Number of fasteners

5/sheet

Cladding thickness		0.42mm BMT			0.48mm BMT			0.60mm BMT		
Span type		Internal	End	Equal	Internal	End	Equal	Internal	End	Equal
Roof	Wind load									
	N1	1300	900	900	1800	1400	1400	1900	1500	1500
	N2	1300	900	900	1800	1400	1400	1900	1500	1500
	N3	1300	900	900	1800	1400	1400	1900	1500	1500
	N4	1300	900	900	1300	1000	1150	1300	1000	1150
	N5	850	650	750	850	650	750	850	650	750
	N6	650	500	550	650	500	550	650	500	550
Wall	Wind load									
	N1	2600	2050	2150	2850	2250	2350	3000	2400	2600
	N2	2600	2050	2150	2850	2250	2350	3000	2400	2600
	N3	1900	1500	1700	1900	1500	1700	1900	1500	1700
	N4	1300	1000	1150	1300	1000	1150	1300	1000	1150
	N5	850	650	750	850	650	750	850	650	750
	N6	650	500	550	650	500	550	650	500	550

Table 7.12 Stramit Corrugated on 0.75mm batten/top hat

Maximum span (mm)

Fasteners:

Roof: M6 x 50mm hex head Zip screws with neoprene washers

Wall: M6 x 25mm hex head Zip screws with neoprene washers

Number of fasteners

3/sheet

Cladding thickness		0.42mm BMT			0.48mm BMT			0.60mm BMT		
Span type		Internal	End	Equal	Internal	End	Equal	Internal	End	Equal
Roof	Wind load									
	N1	1300	900	900	1800	1400	1400	1900	1500	1500
	N2	1300	900	900	1800	1400	1400	1900	1500	1500
	N3	1300	900	900	1500	1200	1350	1500	1200	1350
	N4	1000	800	900	1000	800	900	1000	800	900
	N5	600	450		650	500	550	650	500	550
	N6				500	400	450	500	400	450
Wall	Wind load									
	N1	2750	2150	2150	3000	2400	2400	2700	2150	2650
	N2	2750	2150	2150	3000	2400	2400	2700	2150	2650
	N3	2000	1600	1700	2000	1600	1800	2000	1600	1800
	N4	1350	1050	1200	1350	1050	1200	1350	1050	1200
	N5	900	700	800	900	700	800	900	700	800
	N6				650	500	550	650	500	550

Number of fasteners

5/sheet

Cladding thickness		0.42mm BMT			0.48mm BMT			0.60mm BMT		
Span type		Internal	End	Equal	Internal	End	Equal	Internal	End	Equal
Roof	Wind load									
	N1	1300	900	900	1800	1400	1400	1900	1500	1500
	N2	1300	900	900	1800	1400	1400	1900	1500	1500
	N3	1300	900	900	1800	1400	1400	1900	1500	1500
	N4	1300	900	900	1750	1400	1400	1750	1400	1500
	N5	1200	900	900	1200	950	1050	1200	950	1050
	N6	900	700	800	900	700	800	900	700	800
Wall	Wind load									
	N1	2600	2050	2150	2850	2250	2350	3000	2400	2600
	N2	2600	2050	2150	2850	2250	2350	3000	2400	2600
	N3	2250	1800	1850	2450	1950	2050	2600	2050	2200
	N4	1950	1550	1600	2100	1650	1750	2200	1750	1800
	N5	1600	1250	1400	1600	1250	1400	1600	1250	1400
	N6	1200	950	1050	1200	950	1050	1200	950	1050

Table 7.13 Stramit Corrugated on 1.00mm purlin/top hat

Maximum span (mm)

Fasteners:

Roof: M6 x 50mm hex head Zip screws with neoprene washers

Wall: M6 x 25mm hex head Zip screws with neoprene washers

Number of fasteners

3/sheet

Cladding thickness		0.42mm BMT			0.48mm BMT			0.60mm BMT		
Span type		Internal	End	Equal	Internal	End	Equal	Internal	End	Equal
Roof	Wind load									
	N1	1300	900	900	1800	1400	1400	1900	1500	1500
	N2	1300	900	900	1800	1400	1400	1900	1500	1500
	N3	1300	900	900	1800	1400	1400	1800	1400	1500
	N4	1000	800	900	1200	950	1050	1200	950	1050
	N5	600	450		800	600	700	800	600	700
	N6				600	450	500	600	450	500
Wall	Wind load									
	N1	2750	2150	2150	3000	2400	2400	2700	2150	2650
	N2	2750	2150	2150	3000	2400	2400	2700	2150	2650
	N3	2300	1700	1700	2400	1900	1900	2350	1850	2150
	N4	1550	1200	1300	1600	1250	1400	1600	1250	1400
	N5	950	750	800	1100	850	950	1100	850	950
	N6				800	600	700	800	600	700

Number of fasteners

5/sheet

Cladding thickness		0.42mm BMT			0.48mm BMT			0.60mm BMT		
Span type		Internal	End	Equal	Internal	End	Equal	Internal	End	Equal
Roof	Wind load									
	N1	1300	900	900	1800	1400	1400	1900	1500	1500
	N2	1300	900	900	1800	1400	1400	1900	1500	1500
	N3	1300	900	900	1800	1400	1400	1900	1500	1500
	N4	1300	900	900	1800	1400	1400	1900	1500	1500
	N5	1300	900	900	1400	1100	1250	1400	1100	1250
	N6	1050	800	900	1050	800	900	1050	800	900
Wall	Wind load									
	N1	2600	2050	2150	2850	2250	2350	3000	2400	2600
	N2	2600	2050	2150	2850	2250	2350	3000	2400	2600
	N3	2250	1800	1850	2450	1950	2050	2600	2050	2200
	N4	1950	1550	1600	2100	1650	1750	2200	1750	1800
	N5	1600	1250	1400	1800	1400	1500	1800	1400	1500
	N6	1400	1100	1200	1400	1100	1250	1400	1100	1250

Table 7.14 Stramit Corrugated on 1.20mm steel purlin

Maximum span (mm)

Fasteners:

Roof: 12 x 35mm hex head SD screws with neoprene washers

Wall: 10 x 25mm hex head SD screws with neoprene washers

Number of fasteners

3/sheet

Cladding thickness		0.42mm BMT			0.48mm BMT			0.60mm BMT		
Span type		Internal	End	Equal	Internal	End	Equal	Internal	End	Equal
Roof	Wind load									
	N1	1300	900	900	1800	1400	1400	1900	1500	1500
	N2	1300	900	900	1800	1400	1400	1900	1500	1500
	N3	1300	900	900	1800	1400	1400	1900	1500	1500
	N4	1000	800	900	1300	1000	1050	1300	1000	1150
	N5	600	450		850	650	750	850	650	750
	N6				650	500	550	650	500	550
Wall	Wind load									
	N1	2750	2150	2150	3000	2400	2400	2700	2150	2650
	N2	2750	2150	2150	3000	2400	2400	2700	2150	2650
	N3	2000	1600	1700	2000	1600	1800	2000	1600	1800
	N4	1350	1050	1200	1350	1050	1200	1350	1050	1200
	N5	900	700	800	900	700	800	900	700	800
	N6				650	500	550	650	500	550

Number of fasteners

5/sheet

Cladding thickness		0.42mm BMT			0.48mm BMT			0.60mm BMT		
Span type		Internal	End	Equal	Internal	End	Equal	Internal	End	Equal
Roof	Wind load									
	N1	1300	900	900	1800	1400	1400	1900	1500	1500
	N2	1300	900	900	1800	1400	1400	1900	1500	1500
	N3	1300	900	900	1800	1400	1400	1900	1500	1500
	N4	1300	900	900	1800	1400	1400	1900	1500	1500
	N5	1300	900	900	1550	1200	1350	1550	1200	1300
	N6	1050	800	900	1150	900	1000	1150	900	1000
Wall	Wind load									
	N1	2600	2050	2150	2850	2250	2350	3000	2400	2600
	N2	2600	2050	2150	2850	2250	2350	3000	2400	2600
	N3	2250	1800	1850	2450	1950	2050	2600	2050	2200
	N4	1950	1550	1600	2100	1650	1750	2200	1750	1800
	N5	1600	1250	1400	1600	1250	1400	1600	1250	1400
	N6	1200	950	1050	1200	950	1050	1200	950	1050

Table 7.15 Stramit Corrugated on 1.50mm (and thicker) steel purlin and timber battens



Maximum span (mm)

Fasteners:

Steel Roof: 12 x 35mm hex head SD screws with neoprene washers
 Wall: 10 x 25mm hex head SD screws with neoprene washers

Timber Roof: 12 x 50mm hex head Type 17 screws with neoprene washers
 Wall: 10 x 25mm hex head Type 17 screws with neoprene washers

Number of fasteners 3/sheet

Cladding thickness		0.42mm BMT			0.48mm BMT			0.60mm BMT		
Span type		Internal	End	Equal	Internal	End	Equal	Internal	End	Equal
Roof	Wind load									
	N1	1300	900	900	1800	1400	1400	1900	1500	1500
	N2	1300	900	900	1800	1400	1400	1900	1500	1500
	N3	1300	900	900	1800	1400	1400	1900	1500	1500
	N4	1050	800	900	1400	1050	1050	1650	1300	1500
	N5	600	450		1050	800	850	1300	1000	1150
	N6				800	600	700	950	750	900
Wall	Wind load									
	N1	2750	2150	2150	3000	2400	2400	2700	2150	2650
	N2	2750	2150	2150	3000	2400	2400	2700	2150	2650
	N3	2300	1700	1700	2400	1900	1900	2350	1850	2300
	N4	1550	1200	1300	1800	1400	1400	1950	1550	1750
	N5	950	750	800	1300	1000	1000	1350	1050	1200
	N6				1000	800	800	1000	800	900

Number of fasteners 5/sheet

Cladding thickness		0.42mm BMT			0.48mm BMT			0.60mm BMT		
Span type		Internal	End	Equal	Internal	End	Equal	Internal	End	Equal
Roof	Wind load									
	N1	1300	900	900	1800	1400	1400	1900	1500	1500
	N2	1300	900	900	1800	1400	1400	1900	1500	1500
	N3	1300	900	900	1800	1400	1400	1900	1500	1500
	N4	1300	900	900	1800	1400	1400	1900	1500	1500
	N5	1300	900	900	1600	1250	1350	1550	1200	1300
	N6	1150	900	900	1400	1100	1150	1300	1000	1100
Wall	Wind load									
	N1	2600	2050	2150	2850	2250	2350	3000	2400	2600
	N2	2600	2050	2150	2850	2250	2350	3000	2400	2600
	N3	2250	1800	1850	2450	1950	2050	2600	2050	2200
	N4	1950	1550	1600	2100	1650	1750	2200	1750	1800
	N5	1650	1300	1400	1800	1400	1500	1800	1400	1500
	N6	1400	1100	1200	1550	1200	1300	1500	1200	1250

Table 7.16 Stramit Corrugated on 0.75mm batten/top hat



Maximum span (mm)

Fasteners:

Roof: M6 x 50mm hex head Zip screws with neoprene washers

Wall: M6 x 25mm hex head Zip screws with neoprene washers

Number of fasteners

5/sheet

Cladding thickness		0.42mm BMT			0.48mm BMT			0.60mm BMT		
Span type		Internal	End	Equal	Internal	End	Equal	Internal	End	Equal
Roof	Wind load									
	C1	1100	850	900	1250	1000	1100	1050	800	1000
	C2	800	600	700	850	650	750	800	600	700
	C3	550	400	500	550	400	450	550	400	450
	C4									
Wall	Wind load									
	C1	1600	1250	1400	1500	1200	1400	1200	950	1150
	C2	1050	800	900	1050	800	900	950	750	900
	C3	700	550	600	700	550	600	650	500	600
	C4	500	400	450	500	400	450	500	400	450

Fasteners:

Roof: M6 x 50mm hex head Zip screws with cyclone assemblies

Number of fasteners

5/sheet plus Cyclone caps

Cladding thickness		0.42mm BMT			0.48mm BMT			0.60mm BMT		
Span type		Internal	End	Equal	Internal	End	Equal	Internal	End	Equal
Roof	Wind load									
	C1	1250	900	900	1250	1000	1100	1200	950	1100
	C2	850	650	750	850	650	750	850	650	750
	C3	550	400	450	550	400	450	550	400	450
	C4									



Table 7.17 Stramit Corrugated on 1.00mm purlin/top hat

Maximum span (mm)

Fasteners:

Roof: 14 x 42mm hex head SD screws with neoprene washers

Wall: 14 x 22mm hex head SD screws with neoprene washers

Number of fasteners

5/sheet

Cladding thickness		0.42mm BMT			0.48mm BMT			0.60mm BMT		
Span type		Internal	End	Equal	Internal	End	Equal	Internal	End	Equal
Roof	Wind load									
	C1	1100	850	900	1450	1150	1350	1050	800	1000
	C2	800	600	700	1050	800	950	800	600	700
	C3	550	400	500	750	600	650	550	400	450
	C4				500	400	450			
Wall	Wind load									
	C1	1800	1400	1600	1500	1200	1500	1200	950	1150
	C2	1350	1050	1250	1400	1100	1250	950	750	900
	C3	950	750	850	950	750	850	650	500	600
	C4	700	550	600	700	550	600	500	400	450

Fasteners:

Roof: 14 x 42mm hex head SD screws with cyclone assemblies

Number of fasteners

5/sheet plus cyclone caps

Cladding thickness		0.42mm BMT			0.48mm BMT			0.60mm BMT		
Span type		Internal	End	Equal	Internal	End	Equal	Internal	End	Equal
Roof	Wind load									
	C1	1300	900	900	1650	1300	1400	1200	950	1200
	C2	1100	850	900	1100	850	950	1100	850	950
	C3	750	600	650	750	600	650	750	600	650
	C4	550	400	450	550	400	450	500		

Table 7.18 Stramit Corrugated on 1.20mm purlin/top hat

Maximum span (mm)

Fasteners:

Roof: 14 x 42mm hex head SD screws with neoprene washers

Wall: 14 x 22mm hex head SD screws with neoprene washers



Number of fasteners		5/sheet								
Cladding thickness		0.42mm BMT			0.48mm BMT			0.60mm BMT		
Span type		Internal	End	Equal	Internal	End	Equal	Internal	End	Equal
Roof	Wind load									
	C1	1100	850	900	1450	1150	1350	1050	800	1000
	C2	800	600	700	1100	850	1000	800	600	700
	C3	550	400	500	750	600	650	550	400	450
	C4				500	400	450			
Wall	Wind load									
	C1	1800	1400	1600	1500	1200	1500	1200	950	1150
	C2	1400	1100	1250	1500	1200	1450	950	750	900
	C3	1000	800	950	1150	900	1050	650	500	600
	C4	800	600	700	900	700	800	500	400	450

Fasteners:

Roof: 14 x 42mm hex head SD screws with cyclone assemblies

Number of fasteners		5/sheet plus cyclone caps								
Cladding thickness		0.42mm BMT			0.48mm BMT			0.60mm BMT		
Span type		Internal	End	Equal	Internal	End	Equal	Internal	End	Equal
Roof	Wind load									
	C1	1300	900	900	1800	1400	1400	1200	950	1200
	C2	1250	900	900	1550	1200	1350	1150	900	1050
	C3	950	750	900	1050	800	900	750	600	700
	C4	750	600	650	800	600	700	500	400	

Table 7.19 Stramit Corrugated on 1.50mm (and thicker) steel purlin and timber battens



Maximum span (mm)

Fasteners:

Steel Roof: 14 x 42mm hex head SD screws with neoprene washers
 Wall: 14 x 22mm hex head SD screws with neoprene washers

Timber Roof: 14 x 50mm hex head Type 17 screws with neoprene washers
 Wall: 14 x 25mm hex head Type 17 screws with neoprene washers

Number of fasteners

5/sheet

Cladding thickness		0.42mm BMT			0.48mm BMT			0.60mm BMT		
Span type		Internal	End	Equal	Internal	End	Equal	Internal	End	Equal
Roof	Wind load									
	C1	1100	850	900	1450	1150	1350	1050	800	1000
	C2	800	600	700	1100	850	1000	800	600	700
	C3	550	400	500	750	600	650	550	400	500
	C4				500	400	450			
Wall	Wind load									
	C1	1800	1400	1600	1500	1200	1500	1200	950	1150
	C2	1400	1100	1250	1500	1200	1450	950	750	900
	C3	1000	800	950	1150	900	1050	650	500	600
	C4	800	600	700	900	700	800	500	400	450

Fasteners:

Steel roof: 14 x 42mm hex head SD screws with cyclone assemblies

Timber roof: 14 x 50mm hex head Type 17 screws with cyclone assemblies

Number of fasteners

5/sheet plus cyclone caps

Cladding thickness		0.42mm BMT			0.48mm BMT			0.60mm BMT		
Span type		Internal	End	Equal	Internal	End	Equal	Internal	End	Equal
Roof	Wind load									
	C1	1300	900	900	1800	1400	1400	1200	950	1200
	C2	1250	900	900	1600	1250	1400	1100	900	1050
	C3	950	750	900	1150	900	1050	750	600	700
	C4	750	600	650	900	700	800	500		

Monoclad®

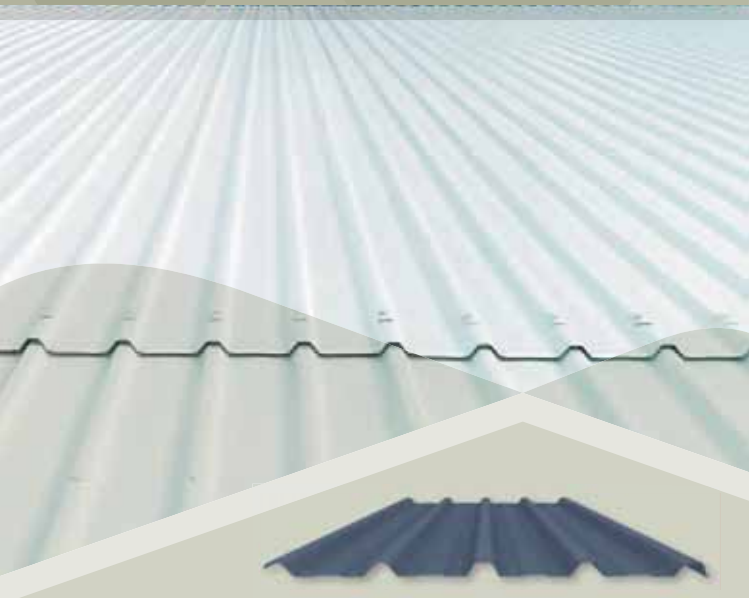

A balanced design of water-carrying capacity, wind load performance and simple fixing makes Monoclad® roof and wall cladding versatile to use.

- 29mm ribs provide excellent spanning and water-carrying capacity
- Compatible with Stramit's MonoLap® roof lap joint system which allows for single plane, long run roofs
- Some system and span combinations certified to FM Global approval standard FM 4471

Mass

Table 7.20 Sheeting mass (kg/m² of area)

BMT (mm)	ZINCALUME® steel	COLORBOND® steel*
0.42	4.28	4.35
0.48	4.86	4.93

For more details on Monoclad® roof and wall cladding, please refer to the Stramit Monoclad® technical manual.

**The above values relate to COLORBOND® steel only and may be different for COLORBOND® Ultra steel, COLORBOND® Metallic steel and SUPERDURA™ Stainless steel.*



AVAILABLE



NOT AVAILABLE



Minimum roof slope

The minimum roof slope for Monoclad® roof and wall cladding is 2 degrees (1 in 30). Please refer to tables 7.2 to 7.5 for roof slope limitations.

Overhangs

The maximum overhang limits for both free edge and stiffened overhangs are shown below. An overhang is defined as the sheet projection past the last row of fasteners and has a minimum value of 50mm. Stiffened overhangs require attachment of an angle or gutter to prevent flexing of the sheet edge.

Table 7.21 Maximum overhang

BMT (mm)	Non-cyclonic		Cyclonic	
	Free edge	Stiffened	Free edge	Stiffened
0.35	100	350	75	150
0.42	150	400	100	200
0.48	200	500	100	250

But in all cases limited to:

- Free edge: to 20% of the back (adjacent end) span
- Stiffened by gutter or angles: to 33% of the back (adjacent end) span

Fastener locations

Stramit's Monoclad® roof and wall cladding can be fixed with 4 fasteners per sheet (at every rib) at each batten/purlin to meet the required performance values.

For roof spans exceeding 900mm and wall spans exceeding 1200mm, stitch side laps at midspan.

Accessories

Stramit can supply matching accessories for this profile including flashings, roll formed ridges, barges, fasteners and translucent sheet in either polycarbonate or fibreglass.

MonoLap® roof lap joint system

This roof lap joint system allows for the installation of lapped sheets on standard purlin framing, without the need for conventional stepped jointing. Stramit's MonoLap® roof lap joints can only be used with Monoclad® roof and wall cladding and with the following provisions:

- Installed on roofs specifically designed for its use
- All purlins must be in a single plane, i.e. no step down
- Purlins must be spaced to allow for sheeting end spans on either side of the joint
- Translucent sheeting joints must coincide with the decking joint

FM Global

The approved system consists of Stramit's Monoclad® roof and wall cladding and 762mm effective cover sheets produced from high tensile steel with class AZ coatings to AS 1397 in plain or pre-painted finish.

The sheet must be secured using either Buildex Auto Tek® M5.5-14 x 50mm or Buildex Roof Zips® M6-11 x 50mm screws at each crest.

Where sidelaps are recommended, they must be Buildex® No 8-15 x 15mm hex head screws and should be used at every lap joint of sheeting at midspan only.

Cyclone assemblies are Buildex cyclone assemblies with No 14-10 x 50mm hex head screws. All steel supports should be a minimum of 1.5mm thick.

Please refer to the Stramit *Roofing Systems with FM Approved Certification* brochure for more details of load and span combinations applicable.

Table 7.22 Monoclad® FM Global specifications on 1.50mm (and thicker) steel purlin

Maximum span (mm)

Fasteners:

Buildex 14 x 50 Auto Tek® or

Buildex M6 x 50 Roof Zips

Sidelap fasteners:

Buildex 8 x 15 DSD hex head screws at midspan on every sidelap

Cyclone assemblies:

Buildex cyclone assemblies with Buildex 14 x 50 SD hex head screws

Base metal thickness (mm)	Support spacing	Additional component	Rating achieved
0.42	900		Class 1-135
0.42	1700	Sidelap fastener	Class 1-90
0.42	900	Cyclone assembly	Class 1-210
0.42	1500	Cyclone assembly & sidelap fasteners	Class 1-150

Performance

The maximum span to suit the design variables can be determined from the following tables. For more information please refer to the How to use the cladding tables section on page 53.

Walls may be subject to impact loads, please refer to page 52 for recommendations.

Please note that Monoclad® roof and wall cladding performance depends upon the batten or purlin used and the fastener specified at the top of each table.

Table 7.23 Monoclad® on 0.48mm batten**Maximum span (mm)**

Fasteners:

Roof: 12 x 50mm hex head Type 17 screws with neoprene washers
or M6 x 65mm hex head Zip screws with neoprene washersWall: 10 x 25mm hex head Type 17 screws with neoprene washers
or M6 x 25mm hex head Zip screws with neoprene washers**Number of fasteners****4/sheet**

Cladding thickness		0.35mm BMT			0.42mm BMT			0.48mm BMT		
Span type		Internal	End	Equal	Internal	End	Equal	Internal	End	Equal
Roof	Wind load									
	N1				2000	1600	1600	2700	2000	2000
	N2				2000	1600	1600	2100	1650	1850
	N3				1350	1050	1200	1350	1050	1200
	N4				900	700	800	900	700	800
	N5				600	450	500	600	450	500
	N6				450	350		450	350	
Wall	Wind load									
	N1	2700	2150	2450	2750	2200	2450	2750	2200	2450
	N2	2000	1600	1800	2000	1600	1800	2000	1600	1800
	N3	1250	1000	1100	1250	1000	1100	1250	1000	1100
	N4	850	650	750	850	650	750	850	650	750
	N5	550	400	450	550	400	450	550	400	450
	N6									

Table 7.24 Monoclad® on 0.55mm batten**Maximum span (mm)**

Fasteners:

Roof: 12 x 50mm hex head Type 17 screws with neoprene washers
or M6 x 65mm hex head Zip screws with neoprene washersWall: 10 x 25mm hex head Type 17 screws with neoprene washers
or M6 x 25mm hex head Zip screws with neoprene washers**Number of fasteners****4/sheet**

Cladding thickness		0.35mm BMT			0.42mm BMT			0.48mm BMT		
Span type		Internal	End	Equal	Internal	End	Equal	Internal	End	Equal
Roof	Wind load									
	N1				2000	1600	1600	2700	2000	2000
	N2				2000	1600	1600	2400	1900	2000
	N3				1550	1200	1350	1550	1200	1350
	N4				1000	800	900	1000	800	900
	N5				700	550	600	700	550	600
	N6				500	400		500	400	450
Wall	Wind load									
	N1	2700	2150	2650	3000	2400	2700	3000	2400	2700
	N2	2400	1900	2150	2400	1900	2150	2400	1900	2150
	N3	1550	1200	1350	1550	1200	1350	1550	1200	1350
	N4	1000	800	900	1000	800	900	1000	800	900
	N5	700	550	600	700	550	600	700	550	600
	N6	500	400	450	500	400	450	500	400	450

Table 7.25 Monoclad® on 0.75mm batten/top hat

Maximum span (mm)

Fasteners:

Roof: M6 x 65mm hex head Zip screws with neoprene washers

Wall: M6 x 25mm hex head Zip screws with neoprene washers

Number of fasteners

4/sheet

Cladding thickness		0.35mm BMT			0.42mm BMT			0.48mm BMT		
Span type		Internal	End	Equal	Internal	End	Equal	Internal	End	Equal
Roof	Wind load									
	N1				2000	1600	1600	2700	2000	2000
	N2				2000	1600	1600	2700	2000	2000
	N3				2000	1600	1600	2100	1650	1850
	N4				1400	1100	1250	1400	1100	1250
	N5				950	750	850	950	750	850
	N6				650	500		700	550	600
Wall	Wind load									
	N1	2700	2150	2650	3000	2400	2700	3000	2400	2700
	N2	2700	2150	2650	3000	2400	2700	3000	2400	2700
	N3	2650	2050	2050	2850	2250	2350	2850	2250	2550
	N4	1900	1500	1650	1900	1500	1700	1900	1500	1700
	N5	1300	1000	1150	1300	1000	1150	1300	1000	1150
	N6	950	750	800	950	750	850	950	750	850

Table 7.26 Monoclad® on 1.00mm batten/top hat

Maximum span (mm)

Fasteners:

Roof: M6 x 65mm hex head Zip screws with neoprene washers

Wall: M6 x 25mm hex head Zip screws with neoprene washers

Number of fasteners

4/sheet

Cladding thickness		0.35mm BMT			0.42mm BMT			0.48mm BMT		
Span type		Internal	End	Equal	Internal	End	Equal	Internal	End	Equal
Roof	Wind load									
	N1				2000	1600	1600	2700	2000	2000
	N2				2000	1600	1600	2700	2000	2000
	N3				2000	1600	1600	2500	2000	2000
	N4				1700	1350	1500	1700	1350	1500
	N5				1150	900	1000	1150	900	1000
	N6				750	600		800	600	600
Wall	Wind load									
	N1	2700	2150	2650	3000	2400	2700	3000	2400	2700
	N2	2700	2150	2650	3000	2400	2700	3000	2400	2700
	N3	2650	2050	2050	2950	2350	2350	3000	2400	2550
	N4	2050	1600	1650	2250	1800	1900	2250	1800	2000
	N5	1500	1200	1250	1500	1200	1350	1500	1200	1350
	N6	1100	850	950	1100	850	950	1100	850	950

Table 7.27 Monoclad® on 1.20mm purlin/top hatNON
CYCLONIC
AREAS 

Maximum span (mm)

Fasteners:

Roof: 12 x 50mm hex head SD screws with neoprene washers

Wall: 10 x 25mm hex head SD screws with neoprene washers

Number of fasteners

4/sheet

Cladding thickness		0.35mm BMT			0.42mm BMT			0.48mm BMT		
Span type		Internal	End	Equal	Internal	End	Equal	Internal	End	Equal
Roof	Wind load									
	N1				2000	1600	1600	2700	2000	2000
	N2				2000	1600	1600	2700	2000	2000
	N3				2000	1600	1600	2700	2000	2000
	N4				1800	1400	1600	1800	1400	1600
	N5				1200	950	1050	1200	950	1050
	N6				900	700		900	650	650
Wall	Wind load									
	N1	2700	2150	2650	3000	2400	2700	3000	2400	2700
	N2	2700	2150	2650	3000	2400	2700	3000	2400	2700
	N3	2650	2050	2050	2850	2250	2350	2850	2250	2550
	N4	1900	1500	1650	1900	1500	1700	1900	1500	1700
	N5	1300	1000	1150	1300	1000	1150	1300	1000	1150
	N6	950	750	800	950	750	850	950	750	850

Table 7.28 Monoclad® on 1.50mm (and thicker) steel purlin and timber battensNON
CYCLONIC
AREAS 

Maximum span (mm)

Fasteners:

Steel Roof: 12 x 50mm hex head SD screws with neoprene washers

Wall: 10 x 25mm hex head SD screws with neoprene washers

Timber Roof: 12 x 65mm hex head Type 17 screws with neoprene washers

Wall: 10 x 25mm hex head Type 17 screws with neoprene washers

Number of fasteners

4/sheet

Cladding thickness		0.35mm BMT			0.42mm BMT			0.48mm BMT		
Span type		Internal	End	Equal	Internal	End	Equal	Internal	End	Equal
Roof	Wind load									
	N1				2000	1600	1600	2700	2000	2000
	N2				2000	1600	1600	2700	2000	2000
	N3				2000	1600	1600	2700	2000	2000
	N4				2000	1600	1600	2350	1850	2000
	N5				1450	1150	1300	1750	1400	1600
	N6				1000	800		1250	950	950
Wall	Wind load									
	N1	2700	2150	2650	3000	2400	2700	3000	2400	2700
	N2	2700	2150	2650	3000	2400	2700	3000	2400	2700
	N3	2650	2050	2050	2950	2350	2350	3000	2400	2550
	N4	2050	1600	1650	2450	1900	1900	2750	2200	2250
	N5	1500	1200	1250	1850	1450	1550	1850	1450	1650
	N6	1200	950	1000	1400	1100	1250	1400	1100	1250

Table 7.29 Monoclad® on 0.75mm batten/top hat



Maximum span (mm)

Fasteners:

Roof: M6 x 50mm hex head Zip screws with neoprene washers

Wall: M6 x 25mm hex head Zip screws with neoprene washers

Number of fasteners

4/sheet

Cladding thickness		0.42mm BMT			0.48mm BMT		
Span type		Internal	End	Equal	Internal	End	Equal
Roof	Wind load						
	C1	850	650	800	1000	800	900
	C2	550	400	550	650	500	550
	C3	450	350		450	350	
	C4						
Wall	Wind load						
	C1	1250	1000	1100	1250	1000	1100
	C2	850	650	750	850	650	750
	C3	550	400	450	550	400	450
	C4						

Fasteners:

Roof: M6 x 50mm hex head Zip screws with cyclone assemblies

Number of fasteners

4/sheet

Cladding thickness		0.42mm BMT			0.48mm BMT		
Span type		Internal	End	Equal	Internal	End	Equal
Roof	Wind load						
	C1	1000	800	900	1000	800	900
	C2	650	500	550	650	500	550
	C3	450	350		450	350	
	C4						

Table 7.30 Monoclad® on 1.00mm purlin/top hat

Maximum span (mm)

Fasteners:

Roof: 14 x 53mm hex head SD screws with neoprene washers

Wall: 14 x 22mm hex head SD screws with neoprene washers

Number of fasteners

4/sheet

Cladding thickness		0.42mm BMT			0.48mm BMT		
Span type		Internal	End	Equal	Internal	End	Equal
Roof	Wind load						
	C1	850	650	800	1050	800	950
	C2	550	400	550	700	550	600
	C3	450	350		450	350	450
	C4						
Wall	Wind load						
	C1	1550	1200	1400	1650	1300	1450
	C2	1100	850	950	1100	850	950
	C3	750	600	650	750	600	650
	C4	550	400	450	550	400	450

Fasteners:

Roof: 14 x 53mm hex head SD screws with cyclone assemblies

Number of fasteners

4/sheet

Cladding thickness		0.42mm BMT			0.48mm BMT		
Span type		Internal	End	Equal	Internal	End	Equal
Roof	Wind load						
	C1	1300	1000	1150	1300	1000	1150
	C2	850	650	800	850	650	800
	C3	600	450	500	600	450	500
	C4	450	350		450	350	

Table 7.31 Monoclad® on 1.20mm purlin

Maximum span (mm)

Fasteners:

Roof: 14 x 53mm hex head SD screws with neoprene washers

Wall: 14 x 22mm hex head SD screws with neoprene washers



Number of fasteners		4/sheet					
Cladding thickness		0.42mm BMT			0.48mm BMT		
Span type		Internal	End	Equal	Internal	End	Equal
Roof	Wind load						
	C1	850	650	800	1050	800	950
	C2	550	400	550	700	550	600
	C3	450	350		450	350	450
	C4						
Wall	Wind load						
	C1	1550	1200	1400	1750	1400	1500
	C2	1150	900	1100	1200	950	1150
	C3	900	700	800	900	700	850
	C4	650	500	600	650	500	600

Fasteners:

Roof: 14 x 53mm hex head SD screws with cyclone assemblies

Number of fasteners		4/sheet					
Cladding thickness		0.42mm BMT			0.48mm BMT		
Span type		Internal	End	Equal	Internal	End	Equal
Roof	Wind load						
	C1	1800	1400	1600	1850	1450	1650
	C2	1250	1000	1100	1250	1000	1100
	C3	850	650	750	850	650	750
	C4	600	450	500	600	450	500

Table 7.32 Monoclad® on 1.50mm (and thicker) steel purlin and timber battens

Maximum span (mm)

Fasteners:

Steel Roof: 14 x 53mm hex head SD screws with neoprene washers
 Wall: 14 x 22mm hex head SD screws with neoprene washers

Timber Roof: 14 x 65mm hex head Type 17 screws with neoprene washers
 Wall: 14 x 25mm hex head Type 17 screws with neoprene washers

Number of fasteners

4/sheet

Cladding thickness		0.42mm BMT			0.48mm BMT		
Span type		Internal	End	Equal	Internal	End	Equal
Roof	Wind load						
	C1	850	650	800	1050	800	950
	C2	550	400	550	700	550	600
	C3	450	350		450	350	450
	C4						
Wall	Wind load						
	C1	1550	1200	1400	1750	1400	1500
	C2	1150	900	1100	1200	950	1150
	C3	900	700	800	900	700	850
	C4	650	500	600	650	500	600

Fasteners:

Steel Roof: 14 x 53mm hex head SD screws with cyclone assemblies

Timber Roof: 14 x 65mm hex head Type 17 screws with cyclone assemblies

Number of fasteners

4/sheet

Cladding thickness		0.42mm BMT			0.48mm BMT		
Span type		Internal	End	Equal	Internal	End	Equal
Roof	Wind load						
	C1	1800	1400	1600	2100	1650	2000
	C2	1250	1000	1200	1600	1250	1450
	C3	950	750	900	1100	850	950
	C4	750	600	650	800	600	700

Stramit Longspan®



The long spans and striking lines of Stramit Longspan® roof and wall cladding provide economical and versatile design options.

- Cost-effective to use and easy to install
- Architectural flexibility accommodates curved roofs and roof pitches as low as 3 degrees
- Variable fixing screw patterns give design flexibility
- Suitable for wall cladding

Mass

Table 7.33 Sheeting mass (kg/m² of area)

BMT (mm)	ZINCALUME® steel	COLORBOND® steel*
0.42	4.66	4.74
0.48	5.29	5.37

For more details on Stramit Longspan® roof and wall cladding, please refer to the Stramit Longspan® technical manual.

**The above values relate to COLORBOND® steel only and may be different for COLORBOND® Ultra steel, COLORBOND® Metallic steel and SUPERDURA™ Stainless steel.*



AVAILABLE



NOT AVAILABLE



Minimum roof slope

The minimum roof slope for Stramit Longspan® roof and wall cladding is 3 degrees (1 in 20). Please refer to tables 7.2 to 7.5 for roof slope limitations.

Overhangs

The maximum overhang limits for both free edge and stiffened overhangs are shown below. An overhang is defined as the sheet projection past the last row of fasteners and has a minimum value of 50mm. Stiffened overhangs require attachment of an angle or gutter to prevent flexing of the sheet edge.

Table 7.34 Maximum overhang

BMT (mm)	Non-cyclonic		Cyclonic	
	Free edge	Stiffened	Free edge	Stiffened
0.42	200	400	100	250
0.48	250	500	150	250

But in all cases limited to:

- Free edge: to 20% of the back (adjacent end) span
- Stiffened by gutter or angles: to 33% of the back (adjacent end) span

Fastener locations

Stramit Longspan® cladding can be fixed with either 3, 4 or 5 fasteners per sheet at each batten/purlin to meet the required performance values, as shown below:

Crest fastener locations



5 fasteners per sheet



4 fasteners per sheet



3 fasteners per sheet

Sidelap fastener

Valley fastener locations (walls only)



4 fasteners per sheet



3 fasteners per sheet

Sidelap fastener

For roof spans exceeding 900mm and wall spans exceeding 1200mm, stitch side laps at midspan.

Accessories

Stramit can supply matching accessories for this profile including flashings, roll formed ridges, barges, fasteners and translucent sheet in either polycarbonate or fibreglass.

Performance

The maximum span to suit the design variables can be determined from the following tables. For more information please refer to the How to use the cladding tables section on page 53.

Walls may be subject to impact loads, please refer to page 52 for recommendations.

Please note that Longspan® roof and wall cladding performance depends on the batten or purlin used and the fastener specified at the top of each table.

Table 7.35 Stramit Longspan® on 0.48mm batten



Maximum span (mm)

Fasteners:

Roof: 12 x 50mm hex head Type 17 screws with neoprene washers or M6 x 65mm hex head Zip screws with neoprene washers

Wall: 10 x 25mm hex head Type 17 screws with neoprene washers or M6 x 25mm hex head Zip screws with neoprene washers

Cladding thickness		Number of fasteners 3/sheet					
		0.42mm BMT			0.48mm BMT		
Span type		Internal	End	Equal	Internal	End	Equal
Roof	Wind load						
	N1	2200	1750	1800	2200	1750	1950
	N2	1600	1250	1400	1600	1250	1400
	N3	1000	800	900	1000	800	900
	N4	650	500		650	500	550
	N5				450	350	
	N6						
Wall	Wind load						
	N1	2100	1650	1850	2100	1650	1850
	N2	1500	1200	1350	1500	1200	1350
	N3	950	750	850	950	750	850
	N4	650	500	550	650	500	550
	N5				450	350	
	N6						

Table 7.36 Stramit Longspan® on 0.55mm batten

Maximum span (mm)

Fasteners:

 Roof: 12 x 50mm hex head Type 17 screws with neoprene washers
 or M6 x 65mm hex head Zip screws with neoprene washers

 Wall: 10 x 25mm hex head Type 17 screws with neoprene washers
 or M6 x 25mm hex head Zip screws with neoprene washers

 NON
 CYCLONIC
 AREAS 

Number of fasteners

3/sheet

Cladding thickness		0.42mm BMT			0.48mm BMT		
		Internal	End	Equal	Internal	End	Equal
Roof	Span type						
	Wind load						
	N1	2400	1800	1800	2550	2000	2250
	N2	1800	1400	1600	1800	1400	1600
	N3	1150	900	1000	1150	900	1000
	N4	750	600		750	600	650
	N5				500	400	500
Wall	Span type						
	Wind load						
	N1	2550	2000	2250	2550	2000	2250
	N2	1800	1400	1600	1800	1400	1600
	N3	1150	900	1000	1150	900	1000
	N4	750	600	650	750	600	650
	N5				500	400	450
N6							

Table 7.37 Stramit Longspan® on 0.75mm batten/top hat

Maximum span (mm)

Fasteners:

Roof: M6 x 65mm hex head Zip screws with neoprene washers

Wall: M6 x 25mm hex head Zip screws with neoprene washers

Number of fasteners

3/sheet

Cladding thickness		0.42mm BMT			0.48mm BMT		
Span type		Internal	End	Equal	Internal	End	Equal
Roof	Wind load						
	N1	2400	1800	1800	3000	2250	2250
	N2	2400	1800	1800	2500	2000	2250
	N3	1600	1250	1200	1600	1250	1400
	N4	900	700		1050	800	900
	N5				700	550	700
	N6						
Wall	Wind load						
	N1	3000	2400	2700	3000	2400	2700
	N2	3000	2400	2700	3000	2400	2700
	N3	2150	1700	1900	2150	1700	1900
	N4	1450	1150	1300	1450	1150	1300
	N5				950	750	850
	N6				700	550	

Table 7.38 Stramit Longspan® on 1.00mm steel purlin

Maximum span (mm)

Fasteners:

Roof: M6 x 65mm hex head Zip screws with neoprene washers

Wall: M6 x 25mm hex head Zip screws with neoprene washers

Number of fasteners

3/sheet

Cladding thickness		0.42mm BMT			0.48mm BMT		
Span type		Internal	End	Equal	Internal	End	Equal
Roof	Wind load						
	N1	2400	1800	1800	3000	2250	2250
	N2	2400	1800	1800	3000	2250	2250
	N3	1900	1500	1700	1900	1500	1700
	N4	900	700		1250	1000	1100
	N5				850	650	800
	N6						
Wall	Wind load						
	N1	3000	2400	2700	3000	2400	2700
	N2	3000	2400	2700	3000	2400	2700
	N3	2500	2000	2200	2550	2000	2250
	N4	1700	1350	1500	1700	1350	1500
	N5				1150	900	1000
	N6				850	650	

Table 7.39 Stramit Longspan® on 1.20mm steel purlinNON
CYCLONIC
AREAS 

Maximum span (mm)

Fasteners:

Steel Roof: 12 x 45mm hex head SD screws with neoprene washers

Wall: 10 x 25mm hex head SD screws with neoprene washers

Number of fasteners

3/sheet

Cladding thickness		0.42mm BMT			0.48mm BMT		
Span type		Internal	End	Equal	Internal	End	Equal
Roof	Wind load						
	N1	2400	1800	1800	3000	2250	2250
	N2	2400	1800	1800	3000	2250	2250
	N3	1900	1500	1700	2050	1600	1800
	N4	900	700		1350	1050	1200
	N5				900	700	850
	N6						
Wall	Wind load						
	N1	3000	2400	2700	3000	2400	2700
	N2	3000	2400	2700	3000	2400	2700
	N3	2150	1700	1900	2150	1700	1900
	N4	1450	1150	1300	1450	1150	1300
	N5				950	750	850
	N6				700	550	

Table 7.40 Stramit Longspan® on 1.50mm (and thicker) steel purlin and timber battensNON
CYCLONIC
AREAS 

Maximum span (mm)

Fasteners:

Steel Roof: 12 x 45mm hex head SD screws with neoprene washers

Wall: 10 x 25mm hex head SD screws with neoprene washers

Timber Roof: 12 x 65mm hex head Type 17 screws with neoprene washers

Wall: 10 x 25mm hex head Type 17 screws with neoprene washers

Number of fasteners

3/sheet

Cladding thickness		0.42mm BMT			0.48mm BMT		
Span type		Internal	End	Equal	Internal	End	Equal
Roof	Wind load						
	N1	2400	1800	1800	3000	2250	2250
	N2	2400	1800	1800	3000	2250	2250
	N3	2050	1600	1700	2500	2000	2200
	N4	900	700		1850	1450	1550
	N5				1050	800	900
	N6						
Wall	Wind load						
	N1	3000	2400	2700	3000	2400	2700
	N2	3000	2400	2700	3000	2400	2700
	N3	2500	2000	2200	3000	2400	2700
	N4	1800	1400	1500	2100	1650	1850
	N5				1400	1100	1250
	N6				1050	800	

Table 7.41 Stramit Longspan® on 0.48mm batten

Maximum span (mm)

Fasteners:

Roof: 12 x 50mm hex head Type 17 screws with neoprene washers
or M6 x 65mm hex head Zip screws with neoprene washers

Wall: 10 x 25mm hex head Type 17 screws with neoprene washers
or M6 x 25mm hex head Zip screws with neoprene washers

Number of fasteners

4/sheet

Cladding thickness		0.42mm BMT			0.48mm BMT		
Span type		Internal	End	Equal	Internal	End	Equal
Roof	Wind load						
	N1	2400	1800	1800	2800	2200	2250
	N2	2000	1600	1800	2000	1600	1800
	N3	1250	1000	1100	1250	1000	1100
	N4	850	650	750	850	650	750
	N5	550	400	450	550	400	450
	N6						
Wall	Wind load						
	N1	2650	2100	2350	2650	2100	2350
	N2	1900	1500	1700	1900	1500	1700
	N3	1200	950	1050	1200	950	1050
	N4	800	600	700	800	600	700
	N5	550	400	450	550	400	450
	N6						

Table 7.42 Stramit Longspan® on 0.55mm batten

Maximum span (mm)

Fasteners:

Roof: 12 x 50mm hex head Type 17 screws with neoprene washers
or M6 x 65mm hex head Zip screws with neoprene washers

Wall: 10 x 25mm hex head Type 17 screws with neoprene washers
or M6 x 25mm hex head Zip screws with neoprene washers

Number of fasteners

4/sheet

Cladding thickness		0.42mm BMT			0.48mm BMT		
Span type		Internal	End	Equal	Internal	End	Equal
Roof	Wind load						
	N1	2400	1800	1800	3000	2250	2250
	N2	2300	1800	1800	2300	1800	2050
	N3	1450	1150	1300	1450	1150	1300
	N4	950	750	850	950	750	850
	N5	650	500	550	650	500	550
	N6	450	350	450	500	400	450
Wall	Wind load						
	N1	3000	2400	2700	3000	2400	2700
	N2	2300	1800	2050	2300	1800	2050
	N3	1450	1150	1300	1450	1150	1300
	N4	950	750	850	950	750	850
	N5	650	500	550	650	500	550
	N6	500	400	450	500	400	450

Table 7.43 Stramit Longspan® on 0.75mm batten/top hat

Maximum span (mm)

Fasteners:

Roof: M6 x 65mm hex head Zip screws with neoprene washers

Wall: M6 x 25mm hex head Zip screws with neoprene washers

Number of fasteners		4/sheet					
Cladding thickness		0.42mm BMT			0.48mm BMT		
Span type		Internal	End	Equal	Internal	End	Equal
Roof	Wind load						
	N1	2400	1800	1800	3000	2250	2250
	N2	2400	1800	1800	3000	2250	2250
	N3	2000	1600	1800	2000	1600	1800
	N4	1350	1050	1200	1350	1050	1200
	N5	900	700	800	900	700	800
	N6	650	500	550	650	500	550
Wall	Wind load						
	N1	3000	2400	2700	3000	2400	2700
	N2	3000	2400	2700	3000	2400	2700
	N3	2700	2150	2400	2700	2150	2400
	N4	1800	1400	1600	1800	1400	1600
	N5	1200	950	1050	1200	950	1050
	N6	900	700	800	900	700	800

Table 7.44 Stramit Longspan® on 1.00mm batten/top hat

Maximum span (mm)

Fasteners:

Roof: M6 x 65mm hex head Zip screws with neoprene washers

Wall: M6 x 25mm hex head Zip screws with neoprene washers

Number of fasteners		4/sheet					
Cladding thickness		0.42mm BMT			0.48mm BMT		
Span type		Internal	End	Equal	Internal	End	Equal
Roof	Wind load						
	N1	2400	1800	1800	3000	2250	2250
	N2	2400	1800	1800	3000	2250	2250
	N3	2350	1800	1800	2400	1900	2150
	N4	1600	1250	1400	1600	1250	1400
	N5	1050	800	900	1050	800	900
	N6	700	550	650	800	600	700
Wall	Wind load						
	N1	3000	2400	2700	3000	2400	2700
	N2	3000	2400	2700	3000	2400	2700
	N3	2850	2250	2600	3000	2400	2700
	N4	2150	1700	1900	2150	1700	1900
	N5	1450	1150	1300	1450	1150	1300
	N6	1050	800	900	1050	800	900

Table 7.45 Stramit Longspan® on 1.20mm batten/top hat

Maximum span (mm)

Fasteners:

Steel Roof: 12 x 45mm hex head SD screws with neoprene washers

Wall: 10 x 25mm hex head SD screws with neoprene washers

Number of fasteners		4/sheet					
Cladding thickness		0.42mm BMT			0.48mm BMT		
Span type		Internal	End	Equal	Internal	End	Equal
Roof	Wind load						
	N1	2400	1800	1800	3000	2250	2250
	N2	2400	1800	1800	3000	2250	2250
	N3	2350	1800	1800	2550	2000	2250
	N4	1700	1350	1500	1700	1350	1500
	N5	1150	900	1000	1150	900	1000
	N6	800	600	700	850	650	750
Wall	Wind load						
	N1	3000	2400	2700	3000	2400	2700
	N2	3000	2400	2700	3000	2400	2700
	N3	2700	2150	2400	2700	2150	2400
	N4	1800	1400	1600	1800	1400	1600
	N5	1200	950	1050	1200	950	1050
	N6	900	700	800	900	700	800

Table 7.46 Stramit Longspan® on 1.50mm (and thicker) steel purlin and timber pattens

Maximum span (mm)

Fasteners:

Steel Roof: 12 x 45mm hex head SD screws with neoprene washers

Wall: 10 x 25mm hex head SD screws with neoprene washers

Timber Roof: 12 x 65mm hex head Type 17 screws with neoprene washers

Wall: 10 x 25mm hex head Type 17 screws with neoprene washers

Number of fasteners		4/sheet					
Cladding thickness		0.42mm BMT			0.48mm BMT		
Span type		Internal	End	Equal	Internal	End	Equal
Roof	Wind load						
	N1	2400	1800	1800	3000	2250	2250
	N2	2400	1800	1800	3000	2250	2250
	N3	2350	1800	1800	2950	2250	2250
	N4	1850	1450	1700	2000	1600	1900
	N5	1350	1050	1300	1450	1150	1400
	N6	950	750	950	1100	850	1050
Wall	Wind load						
	N1	3000	2400	2700	3000	2400	2700
	N2	3000	2400	2700	3000	2400	2700
	N3	2850	2250	2600	3000	2400	2700
	N4	2200	1750	2000	2600	2050	2350
	N5	1700	1350	1600	1800	1400	1600
	N6	1300	1000	1150	1300	1000	1150

Table 7.47 Stramit Longspan® on 0.48mm battenNON
CYCLONIC
AREAS **Maximum span (mm)**

Fasteners:

Roof: 12 x 50mm hex head Type 17 screws with neoprene washers
or M6 x 65mm hex head Zip screws with neoprene washersWall: 10 x 25mm hex head Type 17 screws with neoprene washers
or M6 x 25mm hex head Zip screws with neoprene washers

Number of fasteners		5/sheet					
Cladding thickness		0.42mm BMT			0.48mm BMT		
Span type		Internal	End	Equal	Internal	End	Equal
Roof	Wind load						
	N1	2400	1800	1800	3000	2250	2250
	N2	2400	1800	1800	2650	2100	2250
	N3	1700	1350	1500	1700	1350	1500
	N4	1150	900	1000	1150	900	1000
	N5	750	600	650	750	600	650
	N6	550	400	450	550	400	450
Wall	Wind load						
	N1	3000	2400	2700	3000	2400	2700
	N2	2550	2000	2250	2550	2000	2250
	N3	1600	1250	1400	1600	1250	1400
	N4	1100	850	950	1100	850	950
	N5	750	600	650	750	600	650
	N6	550	400	450	550	400	450

Table 7.48 Stramit Longspan® on 0.55mm battenNON
CYCLONIC
AREAS **Maximum span (mm)**

Fasteners:

Roof: 12 x 50mm hex head Type 17 screws with neoprene washers
or M6 x 65mm hex head Zip screws with neoprene washersWall: 10 x 25mm hex head Type 17 screws with neoprene washers
or M6 x 25mm hex head Zip screws with neoprene washers

Number of fasteners		5/sheet					
Cladding thickness		0.42mm BMT			0.48mm BMT		
Span type		Internal	End	Equal	Internal	End	Equal
Roof	Wind load						
	N1	2400	1800	1800	3000	2250	2250
	N2	2400	1800	1800	3000	2250	2250
	N3	1950	1550	1750	1950	1550	1750
	N4	1300	1000	1150	1300	1000	1150
	N5	900	700	800	900	700	800
	N6	650	500	550	650	500	550
Wall	Wind load						
	N1	3000	2400	2700	3000	2400	2700
	N2	3000	2400	2700	3000	2400	2700
	N3	1950	1550	1750	1950	1550	1750
	N4	1300	1000	1150	1300	1000	1150
	N5	900	700	800	900	700	800
	N6	650	500	550	650	500	550

Table 7.49 Stramit Longspan® on 0.75mm batten/top hat

Maximum span (mm)

Fasteners:

Roof: M6 x 65mm hex head Zip screws with neoprene washers

Wall: M6 x 25mm hex head Zip screws with neoprene washers

Number of fasteners

5/sheet

Cladding thickness		0.42mm BMT			0.48mm BMT		
Span type		Internal	End	Equal	Internal	End	Equal
Roof	Wind load						
	N1	2400	1800	1800	3000	2250	2250
	N2	2400	1800	1800	3000	2250	2250
	N3	2400	1800	1800	2700	2150	2250
	N4	1800	1400	1600	1800	1400	1600
	N5	1200	950	1050	1200	950	1050
	N6	900	700	800	900	700	800
Wall	Wind load						
	N1	3000	2400	2700	3000	2400	2700
	N2	3000	2400	2700	3000	2400	2700
	N3	3000	2400	2600	3000	2400	2700
	N4	2400	1900	2150	2400	1900	2150
	N5	1650	1300	1450	1650	1300	1450
	N6	1200	950	1050	1200	950	1050

Table 7.50 Stramit Longspan® on 1.00mm batten/top hat

Maximum span (mm)

Fasteners:

Roof: M6 x 65mm hex head Zip screws with neoprene washers

Wall: M6 x 25mm hex head Zip screws with neoprene washers

Number of fasteners

5/sheet

Cladding thickness		0.42mm BMT			0.48mm BMT		
Span type		Internal	End	Equal	Internal	End	Equal
Roof	Wind load						
	N1	2400	1800	1800	3000	2250	2250
	N2	2400	1800	1800	3000	2250	2250
	N3	2400	1800	1800	3000	2250	2250
	N4	2150	1700	1800	2150	1700	1900
	N5	1450	1150	1300	1450	1150	1300
	N6	1050	800	900	1050	800	900
Wall	Wind load						
	N1	3000	2400	2700	3000	2400	2700
	N2	3000	2400	2700	3000	2400	2700
	N3	3000	2400	2600	3000	2400	2700
	N4	2650	2100	2250	2850	2250	2550
	N5	1950	1550	1750	1950	1550	1750
	N6	1400	1100	1250	1400	1100	1250

Table 7.51 Stramit Longspan® on 1.20mm batten/top hatNON
CYCLONIC
AREAS 

Maximum span (mm)

Fasteners:

Steel Roof: 12 x 45mm hex head SD screws with neoprene washers

Wall: 10 x 25mm hex head SD screws with neoprene washers

Number of fasteners

5/sheet

Cladding thickness		0.42mm BMT			0.48mm BMT		
Span type		Internal	End	Equal	Internal	End	Equal
Roof	Wind load						
	N1	2400	1800	1800	3000	2250	2250
	N2	2400	1800	1800	3000	2250	2250
	N3	2400	1800	1800	3000	2250	2250
	N4	2300	1800	1800	2300	1800	2050
	N5	1550	1200	1350	1550	1200	1350
	N6	1150	900	1000	1150	900	1000
Wall	Wind load						
	N1	3000	2400	2700	3000	2400	2700
	N2	3000	2400	2700	3000	2400	2700
	N3	3000	2400	2600	3000	2400	2700
	N4	2400	1900	2150	2400	1900	2150
	N5	1650	1300	1450	1650	1300	1450
	N6	1200	950	1050	1200	950	1050

Table 7.52 Stramit Longspan® on 1.50mm (and thicker) steel purlin and timber battensNON
CYCLONIC
AREAS 

Maximum span (mm)

Fasteners:

Steel Roof: 12 x 45mm hex head SD screws with neoprene washers

Wall: 10 x 25mm hex head SD screws with neoprene washers

Timber Roof: 12 x 65mm hex head Type 17 screws with neoprene washers

Wall: 10 x 25mm hex head Type 17 screws with neoprene washers

Number of fasteners

5/sheet

Cladding thickness		0.42mm BMT			0.48mm BMT		
Span type		Internal	End	Equal	Internal	End	Equal
Roof	Wind load						
	N1	2400	1800	1800	3000	2250	2250
	N2	2400	1800	1800	3000	2250	2250
	N3	2400	1800	1800	3000	2250	2250
	N4	2350	1800	1800	2750	2200	2250
	N5	1950	1550	1650	2100	1650	1800
	N6	1300	1000	1200	1450	1150	1350
Wall	Wind load						
	N1	3000	2400	2700	3000	2400	2700
	N2	3000	2400	2700	3000	2400	2700
	N3	3000	2400	2600	3000	2400	2700
	N4	2650	2100	2250	3000	2400	2700
	N5	2300	1800	1900	2400	1900	2150
	N6	1750	1400	1550	1750	1400	1550

Table 7.53 Stramit Longspan® on 0.75mm batten/top hat

Maximum span (mm)

Fasteners:

Roof: M6 x 50mm hex head Zip screws with neoprene washers

Wall: M6 x 25mm hex head Zip screws with neoprene washers



Number of fasteners		5/sheet					
Cladding thickness		0.42mm BMT			0.48mm BMT		
Span type		Internal	End	Equal	Internal	End	Equal
Roof	Wind load						
	C1	1000	800	950	1100	850	1050
	C2	700	550	600	800	600	750
	C3				550	400	450
	C4						
Wall 4/ sheet	Wind load						
	C1	1200	950	1100	1200	950	1100
	C2	800	600	700	800	600	700
	C3	550	400	500	550	400	500
	C4						

Fasteners:

Roof: M6 x 50mm hex head Zip screws with cyclone assemblies

Number of fasteners		5/sheet plus cyclone caps					
Cladding thickness		0.42mm BMT			0.48mm BMT		
Span type		Internal	End	Equal	Internal	End	Equal
Roof	Wind load						
	C1	1300	1000	1150	1300	1000	1150
	C2	850	650	750	850	650	750
	C3	550	400	450	550	400	450
	C4						

Table 7.54 Stramit Longspan® on 1.00mm (and thicker) steel purlin and timber battens



Maximum span (mm)

Fasteners:

Steel Roof: 14 x 53mm hex head SD screws with neoprene washers
 Wall: 14 x 22mm hex head SD screws with neoprene washers

Timber Roof: 14 x 65mm hex head Type 17 screws with neoprene washers
 Wall: 14 x 25mm hex head Type 17 screws with neoprene washers

Number of fasteners

5/sheet

Cladding thickness		0.42mm BMT			0.48mm BMT		
Span type		Internal	End	Equal	Internal	End	Equal
Roof	Wind load						
	C1	1000	800	950	1100	850	1050
	C2	700	550	600	800	600	750
	C3				550	400	450
	C4						
Wall 4/ sheet	Wind load						
	C1	1550	1200	1400	1550	1200	1400
	C2	1050	800	950	1050	800	950
	C3	700	550	650	700	550	650
	C4	500	400	450	500	400	450

Fasteners:

Steel Roof: 14 x 53mm hex head SD screws with cyclone assemblies

Number of fasteners

5/sheet plus cyclone caps

Cladding thickness		0.42mm BMT			0.48mm BMT		
Span type		Internal	End	Equal	Internal	End	Equal
Roof	Wind load						
	C1	1650	1300	1450	1650	1300	1450
	C2	1100	850	950	1100	850	950
	C3	750	600	650	750	600	650
	C4	450	350	500	550	400	500

Table 7.55 Stramit Longspan® on 1.20mm purlin/top hat

Maximum span (mm)

Fasteners:

Steel Roof: 14 x 53mm hex head SD screws with cyclone assemblies

Number of fasteners

5/sheet plus cyclone caps

Cladding thickness		0.42mm BMT			0.48mm BMT		
Span type		Internal	End	Equal	Internal	End	Equal
Roof	Wind load						
	C1	1750	1400	1650	2100	1650	2050
	C2	1350	1050	1300	1600	1250	1400
	C3	1000	800	950	1100	850	950
	C4	750	600	650	750	600	700

Table 7.56 Stramit Longspan® on 1.50mm (and thicker) steel purlin and timber battens

Maximum span (mm)

Fasteners:

Steel Roof: 14 x 53mm hex head SD screws with cyclone assemblies

Timber Roof: 14 x 65mm hex head Type 17 screws with cyclone assemblies

Number of fasteners

5/sheet plus cyclone caps

Cladding thickness		0.42mm BMT			0.48mm BMT		
Span type		Internal	End	Equal	Internal	End	Equal
Roof	Wind load						
	C1	1750	1400	1650	2100	1650	2050
	C2	1350	1050	1300	1600	1250	1400
	C3	1000	800	900	1100	850	1050
	C4	750	600	650	900	700	750

Notes:

CapacityPLUS™ 660

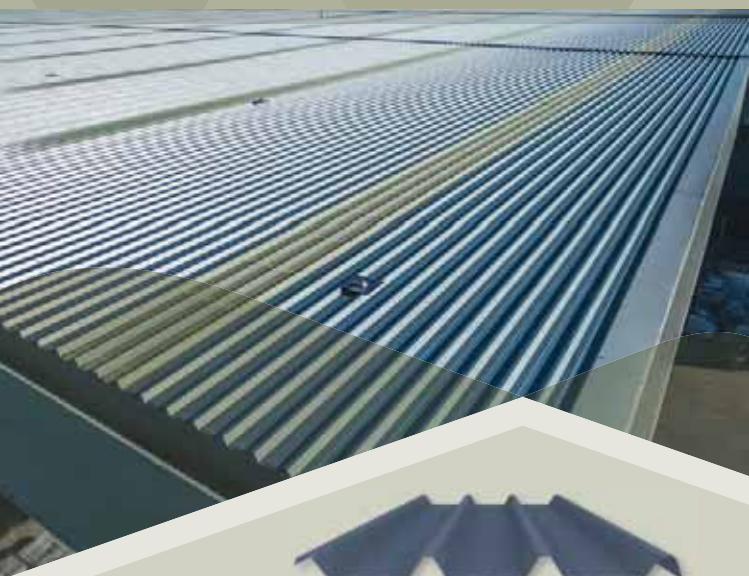

Excellent water drainage and wind load performance make this profile the perfect choice for large roof areas.

- 50mm ribs improve weather tightness and water-carrying capacity
- Rigid profile provides additional spanning capacity
- Screw-fixed for fast handling and laying

Mass

Table 7.57 Sheeting mass (kg/m² of area)

BMT (mm)	ZINCALUME® steel	COLORBOND® steel*
0.42	4.89	4.97
0.48	5.56	5.64

For more details on CapacityPLUS™660 deep roof cladding please refer to the Stramit CapacityPLUS™660 technical manual.

**The above values relate to COLORBOND® steel only and may be different for COLORBOND® Ultra steel, COLORBOND® Metallic steel and SUPERDURA™ Stainless steel.*



Minimum roof slope

The minimum roof slope for Stramit's CapacityPLUS™660 deep roof cladding is 1 degree (1 in 60). Please refer to tables 7.2 to 7.5 for roof slope limitations.

Overhangs

The maximum overhang limits for both free edge and stiffened overhangs are shown below. An overhang is defined as the sheet projection past the last row of fasteners and has a minimum value of 50mm. Stiffened overhangs require attachment of an angle or gutter to prevent flexing of the sheet edge.

Table 7.58 Maximum overhang

BMT (mm)	Non-cyclonic		Cyclonic	
	Free edge	Stiffened	Free edge	Stiffened
0.42	150	400	150	250
0.48	200	500	150	400

But in all cases limited to:

- Free edge: to 20% of the back (adjacent end) span
- Stiffened by gutter or angles: to 33% of the back (adjacent end) span

Fastener locations

Stramit CapacityPLUS™660 deep roof cladding can be fixed with 3 fasteners per sheet (at every rib) at each batten/purlin to meet the required performance values.

For roof spans exceeding 1500mm and wall spans exceeding 1800mm, stitch side laps at midspan.

Accessories

Stramit can supply matching accessories for this profile including flashings, roll formed ridges, barges, fasteners and fibreglass translucent sheet.

Performance

The maximum span to suit the design variables can be determined from the following tables. For more information please refer to the How to use the cladding tables section on page 53.

Walls may be subject to impact loads, please refer to page 52 for recommendations.

Please note that CapacityPLUS™660 deep roof cladding performance depends upon the batten or purlin used and the fastener specified at the top of each table.

Table 7.59 CapacityPLUS™660 on 0.48mm batten

Maximum span (mm)

Fasteners:

Roof: 12 x 65mm hex head Type 17 screws with neoprene washers
or M6 x 65mm hex head Zip screws with neoprene washers

Wall: 10 x 25mm hex head Type 17 screws with neoprene washers
or M6 x 25mm hex head Zip screws with neoprene washers

Number of fasteners

3/sheet

Cladding thickness		0.42mm BMT			0.48mm BMT		
Span type		Internal	End	Equal	Internal	End	Equal
Roof	Wind load						
	N1	2500	2000	2250	2500	2000	2250
	N2	1800	1400	1600	1800	1400	1600
	N3	1150	900	1000	1150	900	1000
	N4	750	600	650	750	600	650
	N5						
	N6						
Wall	Wind load						
	N1	2400	1900	2150	2400	1900	2150
	N2	1700	1350	1500	1700	1350	1500
	N3	1100	850	950	1100	850	950
	N4	750	600	650	750	600	650
	N5						
	N6						

Table 7.60 CapacityPLUS™660 on 0.55mm batten

Maximum span (mm)

Fasteners:

Roof: 12 x 65mm hex head Type 17 screws with neoprene washers
or M6 x 65mm hex head Zip screws with neoprene washers

Wall: 10 x 25mm hex head Type 17 screws with neoprene washers
or M6 x 25mm hex head Zip screws with neoprene washers

Number of fasteners

3/sheet

Cladding thickness		0.42mm BMT			0.48mm BMT		
Span type		Internal	End	Equal	Internal	End	Equal
Roof	Wind load						
	N1	2900	2300	2600	2900	2300	2600
	N2	2100	1650	1850	2100	1650	1850
	N3	1300	1000	1150	1300	1000	1150
	N4	900	700	800	900	700	800
	N5	600	450		600	450	
	N6						
Wall	Wind load						
	N1	2900	2300	2600	2900	2300	2600
	N2	2050	1600	1800	2050	1600	1800
	N3	1300	1000	1150	1300	1000	1150
	N4	900	700	800	900	700	800
	N5	600	450		600	450	
	N6						

Table 7.61 CapacityPLUS™660 on 0.75mm batten/top hat

Maximum span (mm)

Fasteners:

Roof: M6 x 65mm hex head Zip screws with neoprene washers

Wall: M6 x 25mm hex head Zip screws with neoprene washers

NON
CYCLONIC
AREAS 

Number of fasteners		3/sheet					
Cladding thickness		0.42mm BMT			0.48mm BMT		
Span type		Internal	End	Equal	Internal	End	Equal
Roof	Wind load						
	N1	3000	2400	2700	3000	2400	2700
	N2	2850	2250	2550	2850	2250	2550
	N3	1850	1450	1650	1850	1450	1650
	N4	1200	950	1050	1200	950	1050
	N5	800	600	700	800	600	700
	N6	600	450		600	450	
Wall	Wind load						
	N1	3000	2400	2700	3000	2400	2700
	N2	3000	2400	2700	3000	2400	2700
	N3	2450	1950	2200	2450	1950	2200
	N4	1650	1300	1450	1650	1300	1450
	N5	1100	850	950	1100	850	950
	N6	800	600	700	800	600	700

Table 7.62 CapacityPLUS™660 on 1.00mm batten/top hat

Maximum span (mm)

Fasteners:

Roof: M6 x 65mm hex head Zip screws with neoprene washers

Wall: M6 x 25mm hex head Zip screws with neoprene washers

NON
CYCLONIC
AREAS 

Number of fasteners		3/sheet					
Cladding thickness		0.42mm BMT			0.48mm BMT		
Span type		Internal	End	Equal	Internal	End	Equal
Roof	Wind load						
	N1	3000	2400	2700	3000	2400	2700
	N2	3000	2400	2700	3000	2400	2700
	N3	2150	1700	1900	2150	1700	1900
	N4	1250	1000	1100	1450	1150	1300
	N5	850	650	800	950	750	850
	N6	650	500	600	700	550	600
Wall	Wind load						
	N1	3000	2400	2700	3000	2400	2700
	N2	3000	2400	2700	3000	2400	2700
	N3	2800	2200	2550	2900	2300	2650
	N4	1950	1550	1750	1950	1550	1750
	N5	1100	850	1050	1100	850	1000
	N6	850	650	750	850	650	750

Table 7.63 CapacityPLUS™660 on 1.20mm batten/top hat

Maximum span (mm)

Fasteners:

Roof: 12 x 68mm hex head SD screws with neoprene washers

Wall: 10 x 25mm hex head SD screws with neoprene washers

Number of fasteners

3/sheet

Cladding thickness		0.42mm BMT			0.48mm BMT		
Span type		Internal	End	Equal	Internal	End	Equal
Roof	Wind load						
	N1	3000	2400	2700	3000	2400	2700
	N2	3000	2400	2700	3000	2400	2700
	N3	2200	1750	2000	2350	1850	2100
	N4	1250	1000	1100	1550	1200	1350
	N5	850	650	800	1050	800	900
	N6	650	500	600	700	550	650
Wall	Wind load						
	N1	3000	2400	2700	3000	2400	2700
	N2	3000	2400	2700	3000	2400	2700
	N3	2450	1950	2200	2450	1950	2200
	N4	1650	1300	1500	1650	1300	1450
	N5	1100	850	1000	1100	850	950
	N6	850	650	750	800	600	700

Table 7.64 CapacityPLUS™660 on 1.50mm
(and thicker) steel purlin and timber battens

Maximum span (mm)

Fasteners:

Steel Roof: 12 x 68mm hex head SD screws with neoprene washers

Wall: 10 x 25mm hex head SD screws with neoprene washers

Timber Roof: 12 x 95mm hex head Type 17 screws with neoprene washers

Wall: 10 x 25mm hex head Type 17 screws with neoprene washers

Number of fasteners

3/sheet

Cladding thickness		0.42mm BMT			0.48mm BMT		
Span type		Internal	End	Equal	Internal	End	Equal
Roof	Wind load						
	N1	3000	2400	2700	3000	2400	2700
	N2	3000	2400	2700	3000	2400	2700
	N3	2200	1750	2000	2700	2150	2450
	N4	1250	1000	1100	1650	1300	1450
	N5	850	650	800	1050	800	900
	N6	650	500	600	700	550	600
Wall	Wind load						
	N1	3000	2400	2700	3000	2400	2700
	N2	3000	2400	2700	3000	2400	2700
	N3	2800	2200	2550	3000	2400	2700
	N4	2000	1600	1750	2400	1900	2150
	N5	1100	850	1050	1450	1150	1300
	N6	850	650	800	1000	800	900

Table 7.65 CapacityPLUS™660 on 0.75mm batten/top hat

Maximum span (mm)

Fasteners:

Roof: M6 x 65mm hex head Zip screws with cyclone assemblies

Wall: M6 x 65mm hex head Zip screws with cyclone assemblies

Number of fasteners 3/sheet plus cyclone caps

Cladding thickness		0.42mm BMT			0.48mm BMT		
Span type		Internal	End	Equal	Internal	End	Equal
Roof	Wind load						
	C1	850	650	750	850	650	750
	C2	550	400	450	550	400	450
	C3						
	C4						
Wall	Wind load						
	C1	1100	850	950	1100	850	950
	C2	700	550	600	700	550	600
	C3	500	400	450	500	400	450
	C4						

Note: Walls also require 14 x 25mm hex head SD screws with neoprene washers to be attached to the top girt prior to installation of the main fasteners

Table 7.66 CapacityPLUS™660 on 1.00mm purlin/top hat

Maximum span (mm)

Fasteners:

Roof: 14 x 95mm hex head SD screws with cyclone assemblies

Wall: 14 x 95mm hex head SD screws with cyclone assemblies

Number of fasteners 3/sheet plus cyclone caps

Cladding thickness		0.42mm BMT			0.48mm BMT		
Span type		Internal	End	Equal	Internal	End	Equal
Roof	Wind load						
	C1	1150	900	1000	1150	900	1000
	C2	750	600	650	750	600	650
	C3	500	400	450	500	400	450
	C4						
Wall	Wind load						
	C1	1400	1100	1250	1400	1100	1250
	C2	950	750	850	950	750	850
	C3	650	500	550	650	500	550
	C4	450	350		450	350	

Note: Walls also require 14 x 25mm hex head SD screws with neoprene washers to be attached to the top girt prior to installation of the main fasteners

Table 7.67 CapacityPLUS™660 on 1.20mm purlin

Maximum span (mm)

Fasteners:

Roof: 14 x 95mm hex head SD screws with cyclone assemblies

Wall: 14 x 95mm hex head SD screws with cyclone assemblies

Number of fasteners 3/sheet plus cyclone caps

Cladding thickness		0.42mm BMT			0.48mm BMT		
Span type		Internal	End	Equal	Internal	End	Equal
Roof	Wind load						
	C1	1600	1250	1400	1600	1250	1400
	C2	1050	800	950	1100	850	950
	C3	550	400	450	750	600	650
	C4						
Wall	Wind load						
	C1	2050	1600	1800	2050	1600	1800
	C2	1350	1050	1200	1350	1050	1200
	C3	850	650	700	900	700	800
	C4	500	400		650	500	550

Note: Walls also require 14 x 25mm hex head SD screws with neoprene washers to be attached to the top girt prior to installation of the main fasteners

Table 7.68 CapacityPLUS™660 on 1.50mm (and thicker) steel purlin and timber battens

Maximum span (mm)

Fasteners:

Steel Roof: 14 x 95mm hex head SD screws with cyclone assemblies

Wall: 14 x 95mm hex head SD screws with cyclone assemblies

Timber Roof: 14 x 95mm hex head Type 17 screws with cyclone assemblies

Wall: 14 x 95mm hex head Type 17 screws with cyclone assemblies

Number of fasteners 3/sheet plus cyclone caps

Cladding thickness		0.42mm BMT			0.48mm BMT		
Span type		Internal	End	Equal	Internal	End	Equal
Roof	Wind load						
	C1	2050	1600	1850	2100	1650	1850
	C2	1200	950	950	1400	1100	1250
	C3	550	400	450	950	750	850
	C4						
Wall	Wind load						
	C1	2400	1900	2250	2650	2100	2350
	C2	1750	1400	1550	1750	1400	1550
	C3	850	650	700	1200	950	1050
	C4	500	400		900	650	650

Note: Walls also require 14 x 25mm hex head SD screws (or Type 17 for timber) with neoprene washers to be attached to the top girt prior to installation of the main fasteners

Notes:

Speed Deck Ultra[®]

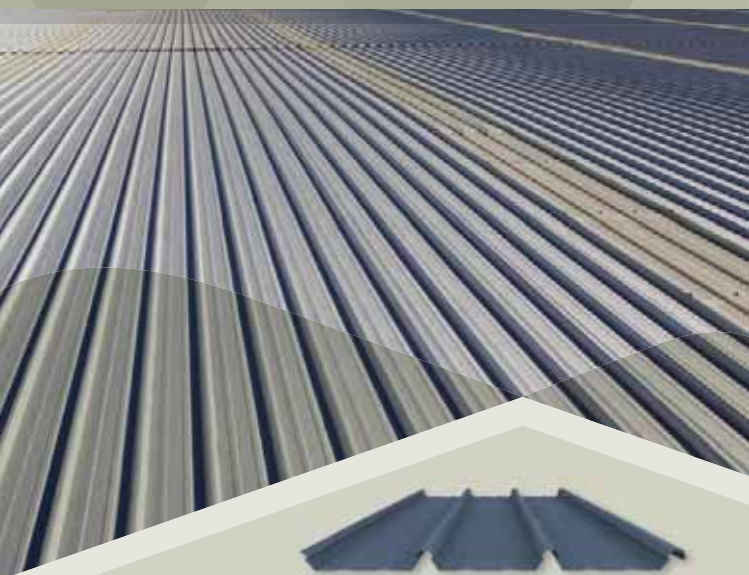

Speed Deck Ultra[®] concealed fixed decking's longer lengths offer unrivalled performance, water-carrying capacity, security and concealed fixing.

- Outstanding wind load resistance and water-carrying capacity
- Full length clips to correctly locate ribs and compress insulation
- Some system and span combinations certified to FM Global approval standard FM 4471
- Automatic bird proofing reduces the need for extra components
- Australian design award winner

Mass

Table 7.69 Sheeting mass (kg/m² of area)

BMT (mm)	ZINCALUME [®] steel	COLORBOND [®] steel*
0.42	4.66	4.74
0.48	5.29	5.37

For more details on Speed Deck Ultra[®] concealed fixed decking, please refer to the Stramit Speed Deck Ultra[®] technical manual.

**The above values relate to COLORBOND[®] steel only and may be different for COLORBOND[®] Ultra steel, COLORBOND[®] Metallic steel and SUPERDURA[™] Stainless steel.*



AVAILABLE



NOT AVAILABLE



Minimum roof slope

The minimum roof slope for Speed Deck Ultra® concealed fixed decking is 1 degree (1 in 60). Please refer to tables 7.2 to 7.5 for roof slope limitations.

Overhangs

The maximum overhang limits for both free edge and stiffened overhangs are shown below. An overhang is defined as the sheet projection past the last row of fasteners and has a minimum value of 50mm. Stiffened overhangs require attachment of an angle or gutter to prevent flexing of the sheet edge.

Table 7.70 Maximum overhang

BMT (mm)	Non-cyclonic		Cyclonic	
	Free edge	Stiffened	Free edge	Stiffened
0.42	150	450	150	450
0.48	200	500	200	450

But in all cases limited to:

- Free edge: to 20% of the back (adjacent end) span
- Stiffened by gutter or angles: to 33% of the back (adjacent end) span

Fastener locations

Stramit's Speed Deck Ultra® concealed fixed decking has purpose made fixing clips to attach the decking to the purlins. These clips require three fasteners positioned between the clip upstands.

Accessories

Stramit can supply matching accessories for this profile including flashings, roll formed ridges, barges, fasteners and fibreglass translucent sheeting.

The Stramit FarLap® roof lap joint

This roof lap joint system allows for the installation of lapped sheets on standard purlin framing, without the need for conventional stepped jointing. Stramit's FarLap® roof lap joints can only be used with Stramit's Speed Deck Ultra® concealed fixed decking and with the following provisions:

- Installed on roofs specifically designed for its use
- All purlins must be in a single plane, i.e. no step down
- Purlins must be spaced to allow for sheeting end spans on either side of the joint
- Translucent sheeting joints using the similar Stramit SkyLap® system, must coincide with the decking joint

FM Global

The approved system consists of Stramit Speed Deck Ultra[®] concealed fixed decking 700mm effective cover sheets produced from hi-tensile steel with Class AZ coating to AS1397-2011 in plain or pre-painted finish.

The sheet has 3 ribs 233mm apart and must be secured using Stramit Speed Deck Ultra[®] clips, with each clip fixed to a steel support of minimum 1.5mm thickness using 3 Buildex[®] 12-14 x 30mm hex head fasteners.

Fletcher Insulation Roof Rack[®] refers to both the 75mm and 100mm high spacers, which are fastened using 3 Buildex[®] 12-14 x 30mm hex head fasteners to the minimum 1.5mm thick steel supports. The Stramit Speed Deck Ultra[®] clips are fastened to the Roof Rack[®] spacers using 3 Buildex[®] 12-14 x 30mm hex head fasteners.

Table 7.71 Speed Deck Ultra[®] FM Global specifications
1.50mm (and thicker) steel purlin

Maximum span (mm)

BMT (mm)	Support spacing	Additional components	Rating achieved
0.48	600	Roof Rack	Class 1-150
0.48	900	Roof Rack	Class 1-150
0.48	1200	Roof Rack	Class 1-90
0.48	1700	Roof Rack	Class 1-75
0.42	600	Roof Rack	Class 1-135
0.42	1200	Roof Rack	Class 1-75

Fasteners: Buildex 12-14x30 hex head fasteners

Roof rack: Both 75mm and 100mm versions installed with 3 Buildex 12-14x30 hex head fasteners

Performance

The maximum span to suit the design variables can be determined from the following tables. For more information please refer to the How to use the cladding tables section on page 53.

Please note that Speed Deck Ultra® concealed fixed decking performance depends upon the batten or purlin used and the fastener specified at the top of each table.

Walls may be subject to impact loads, please refer to page 52 for recommendations.

Table 7.72 Speed Deck Ultra® on 1.00mm steel purlin



Maximum span (mm)

Fasteners:

Roof: 12 x 30mm hex head SD screws

Wall: 12 x 30mm hex head SD screws

Number of fasteners

3/sheet plus 1 fixing clip

Cladding thickness		0.42mm BMT			0.48mm BMT		
Span type		Internal	End	Equal	Internal	End	Equal
Roof	Wind load						
	N1	2300	1800	1850	2900	2300	2400
	N2	2300	1800	1850	2700	2150	2400
	N3	1700	1350	1500	1700	1350	1500
	N4	1150	900	1000	1150	900	1000
	N5	750	600	650	750	600	650
	N6						
Wall	Wind load						
	N1	3000	2400	2650	3000	2400	2700
	N2	3000	2400	2650	3000	2400	2700
	N3	2300	1800	2050	2300	1800	2050
	N4	1550	1200	1350	1550	1200	1350
	N5	1050	800	900	1050	800	900
	N6	750	600	650	750	600	650

Table 7.73 Speed Deck Ultra® on 1.20mm steel purlin

Maximum span (mm)

Fasteners:

Steel Roof: 12 x 30mm hex head SD screws

Wall: 12 x 30mm hex head SD screws

Number of fasteners 3/sheet plus 1 fixing clip

Cladding thickness		0.42mm BMT			0.48mm BMT		
Span type		Internal	End	Equal	Internal	End	Equal
Roof	Wind load						
	N1	2300	1800	1850	2900	2300	2400
	N2	2300	1800	1850	2900	2300	2400
	N3	2200	1750	1850	2200	1750	1950
	N4	1450	1150	1300	1450	1150	1300
	N5	1000	800	900	1000	800	900
	N6						
Wall	Wind load						
	N1	3000	2400	2650	3000	2400	2700
	N2	3000	2400	2650	3000	2400	2700
	N3	2950	2350	2450	2950	2350	2500
	N4	1950	1550	1750	1950	1550	1750
	N5	1350	1050	1200	1350	1050	1200
	N6	1000	800	900	1000	800	900

Table 7.74 Speed Deck Ultra® on 1.50mm (and thicker) steel purlin and timber battens

Maximum span (mm)

Fasteners:

Steel Roof: 12 x 30mm hex head SD screws

Wall: 12 x 30mm hex head SD screws

Timber Roof: 12 x 50mm hex head Type 17 screws

Wall: 12 x 50mm hex head Type 17 screws

Number of fasteners 3/sheet plus 1 fixing clip

Cladding thickness		0.42mm BMT			0.48mm BMT		
Span type		Internal	End	Equal	Internal	End	Equal
Roof	Wind load						
	N1	2300	1800	1850	2900	2300	2400
	N2	2300	1800	1850	2900	2300	2400
	N3	2300	1800	1850	2800	2200	2300
	N4	1950	1550	1700	2100	1650	1800
	N5	1250	1000	1150	1350	1050	1250
	N6						
Wall	Wind load						
	N1	3000	2400	2650	3000	2400	2700
	N2	3000	2400	2650	3000	2400	2700
	N3	3000	2400	2450	3000	2400	2500
	N4	2550	2000	2100	2700	2150	2200
	N5	1750	1400	1550	1900	1500	1650
	N6	1200	950	1150	1350	1050	1250

Table 7.75 Speed Deck Ultra® on 1.50mm
(and thicker) steel purlin and timber battens



Maximum span (mm)

Fasteners:

Steel Roof: 12 x 30mm hex head SD screws

Wall: 12 x 30mm hex head SD screws

Timber Roof: 12 x 50mm hex head Type 17 screws

Wall: 12 x 50mm hex head Type 17 screws

Number of fasteners 3/sheet plus cyclone caps

Cladding thickness		0.42mm BMT			0.48mm BMT		
		Internal	End	Equal	Internal	End	Equal
Roof	Span type						
	Wind load						
	C1	1700	1350	1600	1750	1400	1650
	C2	1300	1000	1200	1300	1000	1200
	C3	900	700	750	900	700	750
	C4				500	400	

Notes:

Stramit Speed Deck® 500



Supplied exclusively in Tasmania, Stramit Speed Deck® 500 concealed fixed decking is lightweight and strong, with improved damage resistance.

- Local supply and delivery make short lead time possible
- Concealed clips for enhanced security and appearance
- Lightweight and high strength with improved damage resistance

Mass

Table 7.76 Sheeting mass (kg/m² of area)

BMT (mm)	ZINCALUME® steel	COLORBOND® steel*
0.42	4.72	4.80
0.48	5.36	5.44
0.60	6.64	6.72

For more details on Stramit Speed Deck® 500 concealed fixed decking, please refer to the Stramit Speed Deck® 500 technical manual.

*The above values relate to COLORBOND® steel only and may be different for COLORBOND® Ultra steel, COLORBOND® Metallic steel and SUPERDURA™ Stainless steel.



AVAILABLE



NOT AVAILABLE



Minimum roof slope

The minimum roof slope for Stramit Speed Deck® 500 concealed fixed decking is 1 degree (1 in 60). Please refer to tables 7.2 to 7.5 for roof slope limitations.

Overhangs

The maximum overhang limits for both free edge and stiffened overhangs are shown below. An overhang is defined as the sheet projection past the last row of fasteners and has a minimum value of 50mm. Stiffened overhangs require attachment of an angle or gutter to prevent flexing of the sheet edge.

Table 7.77 Maximum overhang

BMT	Non-cyclonic	
	Free edge	Stiffened
0.42	100	300
0.48	150	450
0.60	250	500

But in all cases limited to:

- Free edge: to 20% of the back (adjacent end) span
- Stiffened by gutter or angles: to 33% of the back (adjacent end) span

Fastener locations

Stramit Speed Deck® 500 concealed fixed decking has purpose made fixing clips to attach the decking to the purlins. These clips require two fasteners positioned between the clip upstands.

Accessories

Stramit can supply matching accessories for this profile including flashings, roll formed ridges, barges, fasteners and translucent fibreglass sheet.

Performance

The maximum span to suit the design variables can be determined from the following tables. For more information please refer to the How to use the cladding tables section on page 53.

Walls may be subject to impact loads, please refer to page 52 for recommendations.

Please note that Stramit Speed Deck® 500 concealed fixed decking performance depends upon the batten or purlin used and the fastener specified at the top of each table.

Table 7.78 Stramit Speed Deck® 500 on 0.48mm batten

Maximum span (mm)

Fasteners:

Roof: 10 x 25mm wafer head Type 17 screw

Wall: 10 x 25mm wafer head Type 17 screw

Number of fasteners 2/sheet plus 1 fixing clip

Cladding thickness		0.42mm BMT			0.48mm BMT			0.60mm BMT		
Span type		Internal	End	Equal	Internal	End	Equal	Internal	End	Equal
Roof	Wind load									
	N1	1600	1250	1400	1600	1250	1400	1600	1250	1400
	N2	1150	900	1000	1150	900	1000	1150	900	1000
	N3	700	550	600	700	550	600	700	550	600
	N4	450	350	400	450	350	400	450	350	400
	N5									
	N6									
Wall	Wind load									
	N1	2100	1650	1850	2100	1650	1850	2100	1650	1850
	N2	1500	1200	1350	1500	1200	1350	1500	1200	1350
	N3	950	750	850	950	750	850	950	750	850
	N4	650	500	550	650	500	550	650	500	550
	N5	450	350		450	350		450	350	
	N6									

Table 7.79 Stramit Speed Deck® 500 on 0.55mm batten

Maximum span (mm)

Fasteners:

Roof: 10 x 25mm wafer head Type 17 screw

Wall: 10 x 25mm wafer head Type 17 screw

Number of fasteners 2/sheet plus 1 fixing clip

Cladding thickness		0.42mm BMT			0.48mm BMT			0.60mm BMT		
Span type		Internal	End	Equal	Internal	End	Equal	Internal	End	Equal
Roof	Wind load									
	N1	1800	1400	1500	1900	1500	1700	1900	1500	1700
	N2	1350	1050	1200	1350	1050	1200	1350	1050	1200
	N3	850	650	750	850	650	750	850	650	750
	N4	550	400	450	550	400	450	550	400	450
	N5									
	N6									
Wall	Wind load									
	N1	2300	1800	2100	2550	2000	2250	2550	2000	2250
	N2	1800	1400	1600	1800	1400	1600	1800	1400	1600
	N3	1150	900	1000	1150	900	1000	1150	900	1000
	N4	750	600	650	750	600	650	750	600	650
	N5	500	400	450	500	400	450	500	400	450
	N6									

Table 7.80 Stramit Speed Deck® 500 on 0.75mm batten/top hatNON
CYCLONIC
AREAS 

Maximum span (mm)

Fasteners:

Roof: 10 x 25mm wafer head Type 17 screw

Wall: 10 x 25mm wafer head Type 17 screw

Number of fasteners 2/sheet plus 1 fixing clip

Cladding thickness		0.42mm BMT			0.48mm BMT			0.60mm BMT		
Span type		Internal	End	Equal	Internal	End	Equal	Internal	End	Equal
Roof	Wind load									
	N1	1800	1400	1500	1900	1500	1700	1900	1500	1700
	N2	1350	1050	1200	1350	1050	1200	1350	1050	1200
	N3	850	650	750	850	650	750	850	650	750
	N4	550	400	450	550	400	450	550	400	450
	N5									
	N6									
Wall	Wind load									
	N1	2300	1800	2100	2550	2000	2250	2550	2000	2250
	N2	1800	1400	1600	1800	1400	1600	1800	1400	1600
	N3	1150	900	1000	1150	900	1000	1150	900	1000
	N4	750	600	650	750	600	650	750	600	650
	N5	500	400	450	500	400	450	500	400	450
	N6									

Table 7.81 Stramit Speed Deck® 500 on 1.00mm purlin/top hatNON
CYCLONIC
AREAS 

Maximum span (mm)

Fasteners:

Roof: 10 x 22mm wafer head SD screw

Wall: 10 x 22mm wafer head SD screw

Number of fasteners 2/sheet plus 1 fixing clip

Cladding thickness		0.42mm BMT			0.48mm BMT			0.60mm BMT		
Span type		Internal	End	Equal	Internal	End	Equal	Internal	End	Equal
Roof	Wind load									
	N1	1800	1400	1500	2200	1750	1900	2550	2000	2200
	N2	1650	1300	1450	1850	1450	1650	1850	1450	1650
	N3	1150	900	1050	1150	900	1050	1150	900	1050
	N4	800	600	750	800	600	750	800	600	750
	N5	550	400	500	550	400	500	550	400	500
	N6									
Wall	Wind load									
	N1	2300	1800	2100	2850	2250	2700	3000	2400	2700
	N2	1950	1550	1750	2450	1950	2200	2450	1950	2200
	N3	1500	1200	1250	1550	1200	1400	1550	1200	1400
	N4	1050	800	950	1050	800	950	1050	800	950
	N5	750	600	650	750	600	650	750	600	650
	N6	500	400	450	500	400	450	500	400	450

Table 7.82 Stramit Speed Deck® 500 on 1.20mm purlin

Maximum span (mm)

Fasteners:

Roof: 10 x 22mm wafer head SD screw

Wall: 10 x 22mm wafer head SD screw

Number of fasteners 2/sheet plus 1 fixing clip

Cladding thickness		0.42mm BMT			0.48mm BMT			0.60mm BMT		
Span type		Internal	End	Equal	Internal	End	Equal	Internal	End	Equal
Roof	Wind load									
	N1	1800	1400	1500	2200	1750	1900	2650	2100	2200
	N2	1650	1300	1450	2200	1750	1900	2100	1650	1900
	N3	1250	1000	1050	1600	1250	1400	1600	1250	1400
	N4	950	750	800	1050	800	900	1050	800	900
	N5	700	550	600	700	550	600	700	550	600
	N6							550	400	450
Wall	Wind load									
	N1	2300	1800	2100	2850	2250	2700	3000	2400	2700
	N2	1950	1550	1750	2600	2050	2450	2550	2000	2250
	N3	1500	1200	1250	2100	1650	1900	1950	1550	1650
	N4	1150	900	1000	1450	1150	1300	1450	1150	1300
	N5	900	700	800	950	750	850	950	750	850
	N6	700	550	600	700	550	600	700	550	600

Table 7.83 Stramit Speed Deck® 500 on 1.50mm (and thicker) steel purlin and timber battens

Maximum span (mm)

Fasteners:

Steel Roof: 10 x 22mm wafer head SD screw

Wall: 10 x 22mm wafer head SD screw

Timber Roof: 10 x 25mm wafer head Type 17 screw

Wall: 10 x 25mm wafer head Type 17 screw

Number of fasteners 2/sheet plus 1 fixing clip

Cladding thickness		0.42mm BMT			0.48mm BMT			0.60mm BMT		
Span type		Internal	End	Equal	Internal	End	Equal	Internal	End	Equal
Roof	Wind load									
	N1	1800	1400	1500	2200	1750	1900	2650	2100	2200
	N2	1650	1300	1450	2200	1750	1900	2100	1650	1900
	N3	1250	1000	1050	1950	1550	1700	1600	1250	1400
	N4	950	750	800	1550	1200	1350	1300	1000	1150
	N5	750	600	650	1050	800	900	1000	800	900
	N6							800	600	700
Wall	Wind load									
	N1	2300	1800	2100	2850	2250	2700	3000	2400	2700
	N2	1950	1550	1750	2600	2050	2450	2550	2000	2250
	N3	1500	1200	1250	2250	1800	1950	1950	1550	1650
	N4	1150	900	1000	1850	1450	1700	1500	1200	1350
	N5	900	700	800	1400	1100	1250	1200	950	1100
	N6	750	600	650	1050	800	900	1000	800	900

Notes:

SharpLine[®] Direct



Unleash your creativity and let texture take centre stage with SharpLine[®] direct fix architectural cladding.

- Visually striking profile with tall, sharp ribs and flat pans
- Choose from 4 different profiles, featuring 25mm or 38mm rib heights
- Simple to install using direct fixing method

Mass

Table 7.84 Sheeting mass (kg/m² of area)

Rib height (mm)	Cover (mm)	COLORBOND [®] steel*
25	290	6.14
25	490	5.45
38	265	6.72
38	465	5.74

For more details on SharpLine[®] direct fix architectural cladding, please refer to the Stramit SharpLine[®] technical manual.

**The above values relate to COLORBOND[®] steel only and may be different for COLORBOND[®] Ultra steel, COLORBOND[®] Metallic steel and SUPERDURA[™] Stainless steel.*



AVAILABLE



NOT AVAILABLE



Minimum roof slope

Stramit's SharpLine® direct fix architectural cladding can be used to a minimum 3 degree roof pitch (1 in 20). Please refer to tables 7.2 to 7.5 for roof slope limitations.

Overhangs

The maximum overhang limits for both free edge and stiffened overhangs are shown below. An overhang is defined as the sheet projection past the last row of fasteners and has a minimum value of 50mm. Stiffened overhangs require attachment of an angle or gutter to prevent flexing of the sheet edge.

Table 7.85 Maximum overhang

Rib height (mm)	Cover (mm)	Free edge	Stiffened
25	290	50	150
25	490	50	50
38	265	50	150
38	465	50	50

But in all cases limited to:

- Free edge: to 20% of the back (adjacent end) span
- Stiffened by gutter or angles: to 33% of the back (adjacent end) span

Fastener locations

SharpLine® direct fix architectural cladding can be fixed with 1 fastener per sheet at each batten/purlin to meet the required performance values, as shown below:

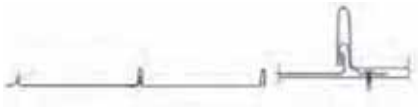

Accessories

Stramit can supply matching accessories for this profile including flashings, roll top ridges, barges and fasteners.

Cyclonic Areas

SharpLine® direct fix cladding can be used on walls in cyclonic areas using spans in the following cyclonic tables. Fixings require the use of a SharpLine® washer installed between the screw head and the sheeting. Additionally, all sheets must be fixed through the rib to each other, approximately 25mm from end of sheet and 10mm above the pan, using a 4.8mm dia 12.7mm grip aluminium blind rivet, through the rib capturing all 4 layers of material.

Performance

The maximum span to suit the design variables can be determined from the following tables. For more information please refer to the How to use the roofing and wall cladding load tables section on page 53.

Please note that SharpLine® direct fix architectural cladding performance depends upon the batten or purlin used and the fastener specified at the top of each table, and deflection under wind uplift has been ignored.



Table 7.86 Stramit SharpLine® direct fix on 0.48mm batten

Maximum span (mm)

Fasteners:

Roof: 10 x 16mm wafer head self drilling screw

Wall: 10 x 16mm wafer head self drilling screw

Number of fasteners 1/sheet

Cladding Rib x Cover	25 x 290						25 x 490						38 x 265						38 x 465							
	Internal		End		Equal		Internal		End		Equal		Internal		End		Equal		Internal		End		Equal			
Roof	Wind load																									
	N1		600		600		450		350		450		900		600		600		450		350		450			
	N2		600		600		450		350		450		900		600		600		450		350		450			
	N3		600		450		500						650		500		600									
	N4																									
	N5																									
N6																										
Wall	Wind load																									
	N1		1200		950		1200		600		450		600		1200		950		1200		600		450		600	
	N2		1200		950		1200		600		450		600		1200		950		1200		600		450		600	
	N3		800		600		700		500		400		900		700		800		500		400					
	N4		550		400		450						600		450		500		400							
	N5																									
N6																										

Values in red require a minimum of 15mm thick CD grade plywood base.

Table 7.87 Stramit SharpLine® direct fix on 0.55mm batten or thicker

Maximum span (mm)

Fasteners:

Steel Roof: 10 x 16mm wafer head self drilling screws

Wall: 10 x 16mm wafer head self drilling screws

Timber Roof: 10 x 25mm wafer head Type 17 screws

Wall: 10 x 25mm wafer head Type 17 screws



Cladding Rib x Cover	Number of fasteners 1/sheet								
	25 x 290		25 x 490		38 x 265		38 x 465		
Span type	Internal	End	Equal	Internal	End	Equal	Internal	End	Equal
Roof									
Wind load									
N1	900	600	600	450	350	450	900	600	600
N2	900	600	600	450	350	450	900	600	600
N3	750	600	600	450	350	450	850	600	600
N4	500	400	450						
N5									
N6									
Wall									
Wind load									
N1	1200	950	1200	600	450	600	1200	950	1200
N2	1200	950	1200	600	450	600	1200	950	1200
N3	950	750	850	600	450	550	1150	900	1000
N4	650	500	550				750	600	650
N5	450	350							
N6									

Values in red require a minimum of 15mm thick CD grade plywood base.

Table 7.88 Stramit SharpLine® direct fix
on 0.75mm (and thicker) steel purlin



Maximum span (mm)

Fasteners:

Steel 10 x 16 wafer head SD screw with Sharpline cyclonic washers

Cladding Rib x Cover		Number of fasteners					
		25 x 290			38 x 265		
Span type		Internal	End	Equal	Internal	End	Equal
Wall	Wind load						
	C1	700	550	650	650	500	650
	C2	450	350				
	C3						
	C4						

Notes:

SharpLine[®] Clip



Unleash your creativity and let texture take centre stage with SharpLine[®] clip fix architectural cladding.

- Visually striking profile with tall, sharp ribs and flat pans
- Choose from 4 different profiles, featuring 25mm or 38mm rib heights
- Clip fixed for added thermal expansion performance

Mass

Table 7.89 Sheeting mass (kg/m² of area)

Rib height (mm)	Cover (mm)	COLORBOND [®] steel*
25	320	5.56
25	520	5.13
38	285	6.25
38	485	5.50

For more details on SharpLine[®] clip fix architectural cladding, please refer to the Stramit SharpLine[®] technical manual.

**The above values relate to COLORBOND[®] steel only and may be different for COLORBOND[®] Ultra steel, COLORBOND[®] Metallic steel and SUPERDURA[™] Stainless steel.*



AVAILABLE



NOT AVAILABLE



Minimum roof slope

Stramit's SharpLine® clip fix architectural cladding can be used to a minimum 3 degree roof pitch (1 in 20). Please refer to tables 7.2 to 7.5 for roof slope limitations.

Overhangs

The maximum overhang limits for both free edge and stiffened overhangs are shown below. An overhang is defined as the sheet projection past the last row of fasteners and has a minimum value of 50mm. Stiffened overhangs require attachment of an angle or gutter to prevent flexing of the sheet edge.

Table 7.90 Maximum overhang

Rib height (mm)	Cover (mm)	Free edge	Stiffened
25	320	50	150
25	520	50	50
38	285	50	150
38	485	50	50

But in all cases limited to:

- Free edge: to 20% of the back (adjacent end) span
- Stiffened by gutter or angles: to 33% of the back (adjacent end) span

Fastener locations

SharpLine® clip fix architectural cladding can be fixed with 2 fasteners per clip at each batten/purlin to meet the required performance values, as shown below:



Accessories

Stramit can supply matching accessories for this profile including flashings, roll top ridges, barges and fasteners.

Cyclonic Areas

SharpLine® clip fix cladding can be used on walls in cyclonic areas using spans in the following cyclonic tables. All sheets must be fixed through the rib to each other, approximately 25mm from end of sheet and 10mm above the pan, using a 4.8mm dia 12.7mm grip aluminium blind rivet, through the rib capturing all 4 layers of material.

Performance

The maximum span to suit the design variables can be determined from the following tables. For more information please refer to the How to use the roofing and wall cladding load tables section on page 51.

Please note that SharpLine® clip fix architectural cladding performance depends upon the batten or purlin used and the fastener specified at the top of each table, and that deflection under wind uplift has been ignored.



Table 7.91 Stramit SharpLine® clip fix on 0.48mm batten

Maximum span (mm)

Fasteners:
 Roof: 10 x 16mm flat head needle point head screws
 Wall: 10 x 16mm flat head needle point head screws

Cladding Rib x Cover		2/clip															
		25 x 320				25 x 520				38 x 285				38 x 485			
		Internal	End	Equal	Equal	Internal	End	Equal	Equal	Internal	End	Equal	Equal	Internal	End	Equal	Equal
Roof	Wind load																
	N1	900	600	600	600	450	350	450	450	900	600	600	600	450	350	450	450
	N2	850	600	600	600	450	350	450	450	900	600	600	600	450	350	450	450
	N3	800	600	600	600					900	550	600	600				
	N4	450	350							650	350						
	N5																
N6																	
Wall	Wind load																
	N1	1200	950	1200	600	600	450	600	600	1200	950	1200	1200	600	450	600	600
	N2	1200	950	1200	600	600	450	600	600	1200	950	1200	1200	600	450	600	600
	N3	1100	850	1000	600	600	350	450	450	1200	950	1200	1200	500	400	450	450
	N4	750	600	600						1100	850	900	900				
	N5									450	350						
N6																	

Values in red require a minimum of 15mm thick CD grade plywood base.

Table 7.92 Stramit SharpLine® clip fix on 0.55mm batten or thicker

Maximum span (mm)

Fasteners:

Steel Roof: 10 x 16mm flat head needle point head screws Timber Roof: 10 x 25mm wafer head Type 17 screws

Wall: 10 x 16mm flat head needle point head screws

Wall: 10 x 25mm wafer head Type 17 screws



Cladding Rib x Cover		Number of fasteners						2/clip					
		25 x 320		25 x 520		38 x 285		38 x 485					
Span type	Wind load	Internal	End	Equal	Internal	End	Equal	Internal	End	Equal	Internal	End	Equal
Roof	N1	900	600	600	450	350	450	900	600	600	450	350	450
	N2	850	600	600	450	350	450	900	600	600	450	350	450
	N3	800	600	600				900	600	600			
	N4	450	350					550	400	450			
	N5												
	N6												
Wall	N1	1200	950	1200	600	450	600	1200	950	1200	600	450	600
	N2	1200	950	1200	600	450	600	1200	950	1200	600	450	600
	N3	1100	850	1000	600	450	500	1200	950	1200	550	400	450
	N4	750	600	600				1100	850	900			
	N5							450	350				
	N6												

Values in red require a minimum of 15mm thick CD grade plywood base.

Table 7.93 Stramit SharpLine® clip fix
on 0.75mm (and thicker) steel purlin



Maximum span (mm)

Fasteners:

Steel 10 x 16 flat head needle point SD screw

Number of fasteners

2/clip per support

Cladding Rib x Cover		25 x 320			38 x 285		
		Internal	End	Equal	Internal	End	Equal
Wall	Span type						
	Wind load						
	C1	650	500	600	800	600	700
	C2				500	400	450
	C3						
	C4						

Notes:

K-Panel[®]



A low profile, K-Panel[®] wall sheeting's wide cover cladding is ideal for smaller buildings and sheds.

- Wide cover makes cost-effective to use
- Quick to install with simple conventional fastening
- Lower profile facilitates smaller flashings for small projects

Mass

Table 7.94 Sheeting mass (kg/m² of area)

BMT (mm)	ZINCALUME [®] steel	COLORBOND [®] steel*
0.42	3.95	4.02
0.48	4.49	4.56

For more details on K-Panel[®] wall sheeting, please refer to the Stramit[®] wall cladding manual.

**The above values relate to COLORBOND[®] steel only and may be different for COLORBOND[®] Ultra steel, COLORBOND[®] Metallic steel and SUPERDURA[™] Stainless steel.*



AVAILABLE



NOT AVAILABLE



Minimum roof slope

Stramit's K-Panel® wall sheeting is not suitable for roofing.

Overhangs

The maximum overhang limits for both free edge and stiffened overhangs are shown below. An overhang is defined as the sheet projection past the last row of fasteners and has a minimum value of 50mm. Stiffened overhangs require attachment of an angle or gutter to prevent flexing of the sheet edge.

Table 7.95 Maximum overhang

BMT (mm)	Non-cyclonic	
	Free edge	Stiffened
0.35	100	100
0.42	100	100

But in all cases limited to:

- Free edge: to 20% of the back (adjacent end) span
- Stiffened by gutter or angles: to 33% of the back (adjacent end) span

Fastener locations

Fix adjacent to the overlap and each subsequent rib (4 fasteners per sheet) at every support. Spans over 900mm require the sidelaps to be stitched at midspan.



Accessories

Stramit can supply matching accessories for this profile including flashings, barges, and fasteners.

Performance

The maximum span to suit the design variables can be determined from the following tables. For more information please refer to the How to use the cladding tables section on page 53.

Walls may be subject to impact loads, please refer to page 52 for recommendations.

Please note that K-Panel® wall sheeting performance depends upon the batten or purlin used and the fastener specified at the top of each table.

Table 7.96 K-Panel® on 0.48mm batten

Maximum span (mm)

Fasteners:

Wall: 10 x 25mm hex head Type 17 screws with neoprene washers
or M6 x 25mm hex head Zip screws with neoprene washers

Number of fasteners

4/sheet

Cladding thickness		0.35mm BMT			0.42mm BMT		
Span type		Internal	End	Equal	Internal	End	Equal
Wall	Wind load						
	N1	1600	1250	1350	1800	1400	1500
	N2	1600	1250	1350	1750	1400	1500
	N3	1100	850	950	1100	850	950
	N4	750	600	650	750	600	650
	N5	500	400	450	500	400	450
	N6						

Table 7.97 K-Panel® on 0.55mm batten

Maximum span (mm)

Fasteners:

Wall: 10 x 25mm hex head Type 17 screws with neoprene washers
or M6 x 25mm hex head Zip screws with neoprene washers

Number of fasteners

4/sheet

Cladding thickness		0.35mm BMT			0.42mm BMT		
Span type		Internal	End	Equal	Internal	End	Equal
Wall	Wind load						
	N1	1600	1250	1350	1800	1400	1500
	N2	1600	1250	1350	1800	1400	1500
	N3	1350	1050	1100	1350	1050	1200
	N4	900	700	800	900	700	800
	N5	600	450	500	600	450	500
	N6	450	350		450	350	

Table 7.98 K-Panel® on 0.75mm batten/top hat

Maximum span (mm)

Fasteners:

Wall: M6 x 25mm hex head Zip screws with neoprene washers

Number of fasteners

4/sheet

Cladding thickness		0.35mm BMT			0.42mm BMT		
Span type		Internal	End	Equal	Internal	End	Equal
Wall	Wind load						
	N1	1600	1250	1350	1800	1400	1500
	N2	1600	1250	1350	1800	1400	1500
	N3	1350	1050	1100	1500	1200	1250
	N4	1100	850	900	1250	1000	1050
	N5	900	700	800	1050	800	850
	N6	800	600	650	850	650	750

Table 7.99 K-Panel® on 1.00mm purlin/tophatNON
CYCLONIC
AREAS 

Maximum span (mm)

Fasteners:

Wall: M6 x 25mm hex head Zip screws with neoprene washers

Number of fasteners

4/sheet

Cladding thickness		0.35mm BMT			0.42mm BMT		
Span type		Internal	End	Equal	Internal	End	Equal
Wall	Wind load						
	N1	1600	1250	1350	1800	1400	1500
	N2	1600	1250	1350	1800	1400	1500
	N3	1350	1050	1100	1500	1200	1250
	N4	1100	850	900	1250	1000	1050
	N5	900	700	800	1050	800	850
	N6	800	600	650	900	700	750

Table 7.100 K-Panel® on 1.20mm (and thicker) steel purlin and timber battensNON
CYCLONIC
AREAS 

Maximum span (mm)

Fasteners:

Steel Wall: 10 x 25mm hex head SD screws with neoprene washers

Timber Wall: 10 x 25mm hex head Type 17 screws with neoprene washers

Number of fasteners

4/sheet

Cladding thickness		0.35mm BMT			0.42mm BMT		
Span type		Internal	End	Equal	Internal	End	Equal
Wall	Wind load						
	N1	1600	1250	1350	1800	1400	1500
	N2	1600	1250	1350	1800	1400	1500
	N3	1350	1050	1100	1500	1200	1250
	N4	1100	850	900	1250	1000	1050
	N5	900	700	800	1050	800	850
	N6	800	600	650	850	650	750

Monoclad®



A strong and economical profile, Monoclad® wall sheeting is ideal for industrial or agricultural buildings.

- 29mm ribs provide excellent spanning capacity
- Low weight for easy installation
- Flat trays enhance the wall appearance and make fixing easier

Mass

Table 7.101 Sheeting mass (kg/m² of area)

BMT (mm)	ZINCALUME® steel	COLORBOND® steel*
0.35	3.53	3.59

For more details on Monoclad® wall cladding, please refer to the Stramit wall cladding technical manual.

**The above values relate to COLORBOND® steel only and may be different for COLORBOND® Ultra steel, COLORBOND® Metallic steel and SUPERDURA™ Stainless steel.*



Minimum roof slope

Stramit's Monoclad® wall sheeting is not suitable for roofing.

Overhangs

The maximum overhang limits for both free edge and stiffened overhangs are shown below. An overhang is defined as the sheet projection past the last row of fasteners and has a minimum value of 50mm. Stiffened overhangs require attachment of an angle or gutter to prevent flexing of the sheet edge.

For details of the overhang limits, please refer to Stramit's Monoclad® roofing section and table 7.21 on page 71.

Fastener locations

Stramit Monoclad® Roof and Wall Cladding can be fixed with 4 fasteners per sheet (beside every rib) at each batten / purlin to meet the required performance values. For spans exceeding 1200mm, stitch side laps at midspan.

Accessories

Stramit can supply matching accessories for this profile including flashings, barges, fasteners and translucent sheet in either polycarbonate or fibreglass.

Performance

The maximum span to suit the design variables can be determined from the following tables. For more information please refer to the How to use the cladding tables section on page 51.

Please note that Stramit's Monoclad® wall sheeting performance depends upon the batten or purlin used and the fastener specified at the top of each table.

Please refer to the Monoclad® performance tables in Stramit's Monoclad® roofing section and tables 7.23 to 7.28.

Walls may be subject to impact loads, please refer to page 52 for recommendations.

Mini Corry®



A corrugated look-a-like, Mini Corry® panelling is a versatile wall cladding that brings architectural features to life.

- Small rib size visually complements Stramit® Corrugated roof and wall cladding
- Conventional fixing for quick installation and seamless finish
- Roll formed to deliver consistent profile and lengths made to order

Mass

Table 7.102 Sheetting mass (kg/m² of area)

BMT (mm)	ZINCALUME® steel	COLORBOND® steel*
0.42	3.95	4.02
0.48	4.49	4.56

For more details on Mini Corry® panelling, please refer to the Stramit® wall cladding technical manual.

**The above values relate to COLORBOND® steel only and may be different for COLORBOND® Ultra steel, COLORBOND® Metallic steel and SUPERDURA™ Stainless steel.*



Minimum roof slope

Stramit's Mini Corry® panelling is not suitable for roofing.

Overhangs

The maximum overhang limits for both free edge and stiffened overhangs are shown below. An overhang is defined as the sheet projection past the last row of fasteners and has a minimum value of 50mm. Stiffened overhangs require attachment of an angle or gutter to prevent flexing of the sheet edge.

Table 7.103 Maximum overhang

Product	Non-cyclonic	
	Free edge	Stiffened
Mini Corry®	100	100

But in all cases limited to:

- Free edge: to 20% of the back (adjacent end) span
- Stiffened by gutter or angles: to 33% of the back (adjacent end) span

Fastener locations

Exposed applications require valley fixing to ensure an anti-capillary space aids in weather protection. Mini Corry® panelling is usually fixed with 7 fasteners per sheet. For internal applications Mini Corry® panelling with spaces of 1000mm or more requires the sidelap to be stitched at midspan.

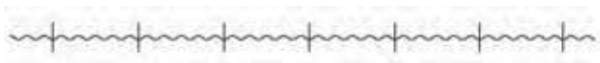

Accessories

Stramit can supply matching accessories for this profile including flashings, barges and fasteners.

Performance

The maximum span to suit the design variables can be determined from the following tables. For more information please refer to the How to use the cladding tables section on page 53.

Walls may be subject to impact loads, please refer to page 52 for recommendations.

Please note that Stramit's Mini Corry® panelling performance depends upon the batten or purlin used and the fastener specified at the top of each table.

Table 7.104 Mini Corry® on 0.48mm batten

Maximum span (mm)

Fasteners:

Steel: 10 x 25mm RippleZIPS®

Number of fasteners		7/sheet		
Cladding thickness		0.42mm		
Span type		Internal	End	Equal
Wall	Wind load			
	N1	1250	1000	1250
	N2	1250	1000	1250
	N3	1100	850	1100
	N4	1000	800	1000
	N5	850	650	800
	N6	700	550	600

Table 7.105 Mini Corry® on 0.55mm batten

Maximum span (mm)

Fasteners:

Steel: 10 x 25mm RippleZIPS®

Number of fasteners		7/sheet		
Cladding thickness		0.42mm		
Span type		Internal	End	Equal
Wall	Wind load			
	N1	1250	1000	1250
	N2	1250	1000	1250
	N3	1100	850	1100
	N4	1000	800	1000
	N5	850	650	850
	N6	800	600	700

Table 7.106 Mini Corry® on 0.75mm batten

Maximum span (mm)

Fasteners:

Steel: 10 x 25mm RippleZIPS®

Number of fasteners		7/sheet		
Cladding thickness		0.42mm		
Span type		Internal	End	Equal
Wall	Wind load			
	N1	1250	1000	1250
	N2	1250	1000	1250
	N3	1100	850	1100
	N4	1000	800	1000
	N5	850	650	850
	N6	800	600	700

Table 7.107 Mini Corry® on 1.00mm purlinNON
CYCLONIC
AREAS 

Maximum span (mm)

Fasteners:

Steel: 10 x 25mm RippleZIPS®

Number of fasteners		7/sheet		
Cladding thickness		0.42mm		
Span type		Internal	End	Equal
Wall	Wind load			
	N1	1250	1000	1250
	N2	1250	1000	1250
	N3	1100	850	1100
	N4	1000	800	1000
	N5	850	650	850
	N6	800	600	800

Table 7.108 Mini Corry® on 1.20mm (and thicker)
steel purlin and timber battensNON
CYCLONIC
AREAS 

Maximum span (mm)

Fasteners:

Steel: 10 x 25mm RippleZIPS®

Timber: 10 x 25mm RippleZIPS®

Number of fasteners		7/sheet		
Cladding thickness		0.42mm		
Span type		Internal	End	Equal
Wall	Wind load			
	N1	1250	1000	1250
	N2	1250	1000	1250
	N3	1100	850	1100
	N4	1000	800	1000
	N5	850	650	850
	N6	800	600	800

Table 7.109 Mini Corry® on 1.50mm (and thicker)
steel purlin and timber battensCYCLONIC
AREAS 

Maximum span (mm)

Fasteners:

Steel: 10 x 16mm wafer head SD screws

Timber: 10 x 30mm wafer head Type 17 screws

Number of fasteners		7/sheet					
Cladding thickness		0.42mm			0.48mm		
Span type		Internal	End	Equal	Internal	End	Equal
Wall	Wind load						
	C1	900	700	900	900	700	900
	C2	800	600	750	850	650	800
	C3	600	450	500	700	550	650
	C4	450	350		550	400	450

Stramit Minirib®



The wide cover and low rib height of Stramit Minirib® panelling makes for near-flat panelling suitable for a range of applications.

- Ideal for internal wall linings, fascias, eaves, transport siding and transportable buildings
- Conventional fixing makes it quick to install
- Stramit's widest cover cladding
- In Western Australia, a modified version with seamed sidelaps is also available. Called Stramit MiniSeam® interlocking cladding, this product is identical in most respects to standard Minirib® panelling

Mass

Table 7.110 Sheetting mass (kg/m² of area)

BMT (mm)	ZINCALUME® steel	COLORBOND® steel*
0.42	3.62	3.68

For more details on Stramit Minirib®, please refer to the Stramit wall cladding technical manual.

Minimum roof slope

Stramit Minirib® panelling is not suitable for roofing.

**The above values relate to COLORBOND® steel only and may be different for COLORBOND® Ultra steel, COLORBOND® Metallic steel and SUPERDURA™ Stainless steel.*



Overhangs

The maximum overhang limits for both free edge and stiffened overhangs are shown below. An overhang is defined as the sheet projection past the last row of fasteners and has a minimum value of 50mm. Stiffened overhangs require attachment of an angle or gutter to prevent flexing of the sheet edge.

Table 7.111 Maximum overhang

Product	Non-cyclonic	
	Free edge	Stiffened
Minirib®	100	100

But in all cases limited to:

- Free edge: to 20% of the back (adjacent end) span
- Stiffened by gutter or angles: to 33% of the back (adjacent end) span

Fastener locations

For external applications, sidelap fasteners are required at 200-300mm centres. At all supports, four equally spaced fasteners are required across the sheet including one fastener through or adjacent to the overlap.

For internal applications Stramit Minirib® panelling with spaces of 1000mm or more requires the sidelap to be stitched at mid span.



850mm cover



900mm cover



1000mm cover

Accessories

Stramit can supply matching accessories for this profile including flashings, barges and fasteners.

Performance

The maximum span to suit the design variables can be determined from the following tables. For more information please refer to the How to use the cladding tables section on page 53. Walls may be subject to impact loads, please refer to page 52 for recommendations.

Please note that Stramit Minirib® panelling performance depends upon the batten or purlin used and the fastener specified at the top of each table.

Please note Stramit Miniseam® is only available in Western Australia.

Table 7.112 Stramit Minirib® on 0.48mm batten

Maximum span (mm)

Fasteners:

Steel: 10 x 25mm hex head Type 17 screws with neoprene washers
or M6 x 25mm hex head Zip screws with neoprene washers

Number of fasteners		3/sheet		
Cladding thickness		0.42mm		
Span type		Internal	End	Equal
Wall	Wind load			
	N1	1600	1250	1550
	N2	1250	1000	1100
	N3	800	600	700
	N4	550	400	450
	N5			
	N6			

Table 7.113 Stramit Minirib® on 0.55mm batten

Maximum span (mm)

Fasteners:

Steel: 10 x 25mm hex head Type 17 screws with neoprene washers
or M6 x 25mm hex head Zip screws with neoprene washers

Number of fasteners		3/sheet		
Cladding thickness		0.42mm		
Span type		Internal	End	Equal
Wall	Wind load			
	N1	1600	1250	1600
	N2	1350	1050	1350
	N3	950	750	850
	N4	650	500	550
	N5	450	350	
	N6			

Table 7.114 Stramit Minirib® on 0.75mm batten

Maximum span (mm)

Fasteners:

Steel: M6 x 25mm hex head Zip screws with neoprene washers

Number of fasteners		3/sheet		
Cladding thickness		0.42mm		
Span type		Internal	End	Equal
Wall	Wind load			
	N1	1600	1250	1600
	N2	1350	1050	1350
	N3	1050	800	900
	N4	850	650	850
	N5	700	550	700
	N6			

Table 7.115 Stramit Minirib® on 1.00mm purlinNON
CYCLONIC
AREAS 

Maximum span (mm)

Fasteners:

Steel: M6 x 25mm hex head Zip screws with neoprene washers

Number of fasteners		3/sheet		
Cladding thickness		0.42mm		
Span type		Internal	End	Equal
Wall	Wind load			
	N1	1600	1250	1600
	N2	1350	1050	1350
	N3	1050	800	900
	N4	850	650	850
	N5	700	550	700
	N6			

Table 7.116 Stramit Minirib® on 1.20mm (and thicker) steel purlin and timber battensNON
CYCLONIC
AREAS 

Maximum span (mm)

Fasteners:

Steel: 10 x 25mm hex head SD screws with neoprene washers

Timber: 10 x 25mm hex head Type 17 screws with neoprene washers

Number of fasteners		3/sheet		
Cladding thickness		0.42mm		
Span type		Internal	End	Equal
Wall	Wind load			
	N1	1600	1250	1600
	N2	1350	1050	1350
	N3	1050	800	900
	N4	850	650	850
	N5	700	550	700
	N6			

Table 7.117 Stramit Miniseam® on 1.20mm (and thicker) steel purlinCYCLONIC
AREAS 

Maximum span (mm)

Fasteners:

Steel: 14 x 25 hex head SD screw with neoprene washers

Number of fasteners		8/sheet		
Cladding thickness		0.42mm		
Span type		Internal	End	Equal
Wall	Wind load			
	C1	1000	800	1000
	C2	850	650	850
	C3	800	600	800
	C4	700	550	650

Monopanel®

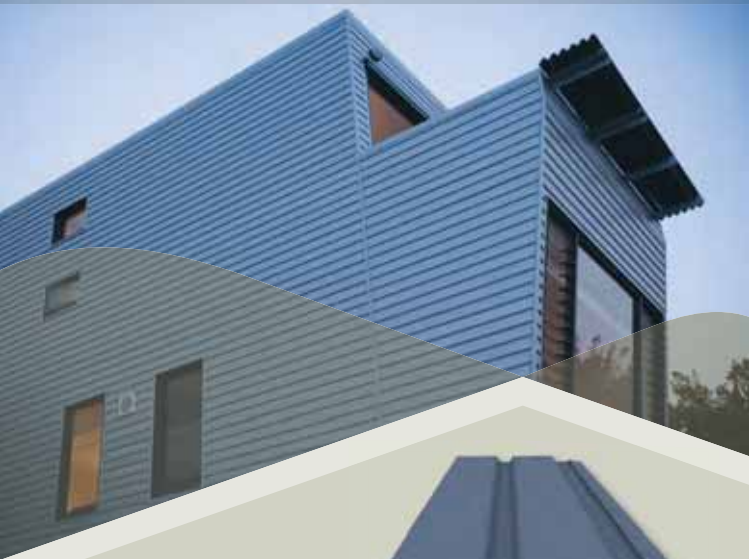

Easy to use, Monopanel® wall cladding features concealed fixing and traditional lines that enhance any house or shed.

- Durable system of interlocking panels with fully concealed fasteners
- Suitable for horizontal and vertical applications
- Traditional lines that enhance any wall

Mass

Table 7.118 Sheetting mass (kg/m² of area)

BMT (mm)	ZINCALUME® steel	COLORBOND® steel*
0.48	4.51	4.58

For more details on Monopanel® wall cladding, please refer to the Stramit® wall cladding technical manual.

**The above values relate to COLORBOND® steel only and may be different for COLORBOND® Ultra steel, COLORBOND® Metallic steel and SUPERDURA™ Stainless steel.*



Minimum roof slope

Stramit's Monopanel® wall cladding is not suitable for roofing.

Overhangs

The maximum overhang limits for both free edge and stiffened overhangs are shown below. An overhang is defined as the sheet projection past the last row of fasteners and has a minimum value of 50mm. Stiffened overhangs require attachment of an angle or gutter to prevent flexing of the sheet edge.

Table 7.119 Maximum overhang

Product	Non-cyclonic	
	Free edge	Stiffened
Monopanel®	100	200

But in all cases limited to:

- Free edge: to 20% of the back (adjacent end) span
- Stiffened by gutter or angles: to 33% of the back (adjacent end) span

Fastener locations

Use one fastener per sheet at each support placed in the pre-punched slots.

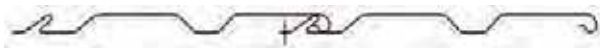

Accessories

Stramit can supply matching accessories for this profile including flashings, barges and fasteners.

Performance

The maximum span to suit the design variables can be determined from the following tables. For more information please refer to the How to use the cladding tables section on page 53.

Walls may be subject to impact loads, please refer to page 52 for recommendations.

Please note that Stramit's Monopanel® wall cladding performance depends upon the batten or purlin used and the fastener specified at the top of each table.

Table 7.120 Stramit Monopanel® on 0.48mm batten

Maximum span (mm)

Fasteners:

10 x 25mm wafer head Type 17 screws

Number of fasteners		1/sheet		
Cladding thickness		0.48mm		
Span type		Internal	End	Equal
Wall	Wind load			
	N1	2100	1650	1850
	N2	1500	1200	1350
	N3	950	750	850
	N4	650	500	550
	N5	450	350	
	N6			

Table 7.121 Stramit Monopanel® on 0.55mm batten

Maximum span (mm)

Fasteners:

10 x 25mm wafer head Type 17 screws

Number of fasteners		1/sheet		
Cladding thickness		0.48mm		
Span type		Internal	End	Equal
Wall	Wind load			
	N1	2550	2000	2250
	N2	1800	1400	1600
	N3	1150	900	1000
	N4	750	600	650
	N5	500	400	450
	N6			

Table 7.122 Stramit Monopanel® on 0.75mm batten/top hat

Maximum span (mm)

Fasteners:

10 x 25mm wafer head Type 17 screws

Number of fasteners		1/sheet		
Cladding thickness		0.48mm		
Span type		Internal	End	Equal
Wall	Wind load			
	N1	2550	2000	2250
	N2	1800	1400	1600
	N3	1150	900	1000
	N4	750	600	650
	N5	500	400	450
	N6			

Table 7.123 Stramit Monopanel® on 1.00mm purlin/top hatNON
CYCLONIC
AREAS 

Maximum span (mm)

Fasteners:

10 x 16mm wafer head SD screws

Number of fasteners		1/sheet		
Cladding thickness		0.48mm		
Span type		Internal	End	Equal
Wall	Wind load			
	N1	2700	2150	2700
	N2	2450	1950	2200
	N3	1550	1200	1350
	N4	1050	800	900
	N5	700	550	600
	N6	500	400	450

Table 7.124 Stramit Monopanel® on 1.20mm (and thicker) steel purlin and timber battensNON
CYCLONIC
AREAS 

Maximum span (mm)

Fasteners:

Steel: 10 x 16mm wafer head SD screws

Timber: 10 x 25mm wafer head Type 17 screws

Number of fasteners		1/sheet		
Cladding thickness		0.48mm		
Span type		Internal	End	Equal
Wall	Wind load			
	N1	2700	2150	2700
	N2	2700	2150	2700
	N3	1800	1400	1800
	N4	1250	1000	1250
	N5	900	700	900
	N6	700	550	650

C-Clad 280



Easy to use, Stramit's C-Clad 280 wall sheeting features traditional lines and concealed fixing to enhance any house or shed.

- Durable system of interlocking panels with fully concealed fasteners
- Suitable for horizontal and vertical applications, or any angle in between
- Low profile for easy flashing and cleaning

Mass

Table 7.125 Sheeting mass (kg/m² of area)

BMT (mm)	ZINCALUME® steel	COLORBOND® steel*
0.55	5.55	5.66

For more details on C-Clad 280 wall cladding, please refer to the Stramit® wall cladding technical manual.

**The above values relate to COLORBOND® steel only and may be different for COLORBOND® Ultra steel, COLORBOND® Metallic steel and SUPERDURA™ Stainless steel.*



Minimum roof slope

Stramit® C-Clad 280 wall sheeting is not suitable for roofing.

Overhangs

The maximum overhang limits for both free edge and stiffened overhangs are shown below. An overhang is defined as the sheet projection past the last row of fasteners and has a minimum value of 50mm. Stiffened overhangs require attachment of an angle or gutter to prevent flexing of the sheet edge.

Table 7.126 Maximum overhang

Product	Non-cyclonic	
	Free edge	Stiffened
C-Clad 280	100	250

But in all cases limited to:

- Free edge: to 20% of the back (adjacent end) span
- Stiffened by gutter or angles: to 33% of the back (adjacent end) span

Fastener locations

Use one fastener per sheet at each support placed in top of the profile outboard of the interlock rib.



Accessories

Stramit can supply matching accessories for this profile including flashings, barges and fasteners.

Performance

The maximum span to suit the design variables can be determined from the following tables. For more information please refer to the How to use the cladding tables section on page 53.

Walls may be subject to impact loads, please refer to page 52 for recommendations.

Please note that Stramit® C-Clad 280 wall sheeting performance depends upon the batten or purlin used and the fastener specified at the top of each table.

Table 7.127 C-Clad 280 on 0.48mm batten

Maximum span (mm)

Fasteners:

10 x 25mm wafer head Type 17 screws

Number of fasteners		1/sheet		
Cladding thickness		0.55mm		
Span type		Internal	End	Equal
Wall	Wind load			
	N1	1850	1450	1650
	N2	1350	1050	1200
	N3	850	650	750
	N4	550	400	450
	N5			
	N6			

Table 7.128 C-Clad 280 on 0.55mm batten

Maximum span (mm)

Fasteners:

10 x 25mm wafer head Type 17 screws

Number of fasteners		1/sheet		
Cladding thickness		0.55mm		
Span type		Internal	End	Equal
Wall	Wind load			
	N1	2250	1800	2000
	N2	1600	1250	1400
	N3	1050	800	900
	N4	700	550	600
	N5	450	350	
	N6			

Table 7.129 C-Clad 280 on 0.75mm batten/top hat

Maximum span (mm)

Fasteners:

10 x 25mm wafer head Type 17 screws

Number of fasteners		1/sheet		
Cladding thickness		0.55mm		
Span type		Internal	End	Equal
Wall	Wind load			
	N1	2250	1800	2000
	N2	1600	1250	1400
	N3	1050	800	900
	N4	700	550	600
	N5	450	350	
	N6			

Table 7.130 C-Clad 280 on 1.00mm purlin/top hatNON
CYCLONIC
AREAS 

Maximum span (mm)

Fasteners:

10 x 16mm wafer head SD screws

Number of fasteners		1/sheet		
Cladding thickness		0.55mm		
Span type		Internal	End	Equal
Wall	Wind load			
	N1	2400	1900	2400
	N2	1900	1500	1900
	N3	1300	1000	1250
	N4	900	700	800
	N5	600	450	500
	N6			

Table 7.131 C-Clad 280 on 1.20mm (and thicker) steel purlin and timber battensNON
CYCLONIC
AREAS 

Maximum span (mm)

Fasteners:

Steel: 10 x 16mm wafer head SD screws

Timber: 10 x 25mm wafer head Type 17 screws

Number of fasteners		1/sheet		
Cladding thickness		0.55mm		
Span type		Internal	End	Equal
Wall	Wind load			
	N1	2400	1900	2400
	N2	1900	1500	1900
	N3	1300	1000	1300
	N4	950	750	950
	N5	700	550	700
	N6			

Premier 300™



Stramit's Premier 300™ architectural cladding is the architectural panel of choice for commercial structures.

- Wide cover makes it cost effective to use
- Durable system of interlocking panels with fully concealed fasteners
- Suitable for horizontal and vertical applications, or any angle in between

Mass

Table 7.132 Sheetting mass (kg/m² of area)

BMT (mm)	ZINCALUME® steel	COLORBOND® steel*
0.55	5.55	5.66

For more details on Premier 300™ architectural cladding, please refer to the Stramit® wall cladding technical manual.

**The above values relate to COLORBOND® steel only and may be different for COLORBOND® Ultra steel, COLORBOND® Metallic steel and SUPERDURA™ Stainless steel.*



Minimum roof slope

Stramit's Premier 300™ architectural cladding is not suitable for roofing.

Overhangs

The maximum overhang limits for both free edge and stiffened overhangs are shown below. An overhang is defined as the sheet projection past the last row of fasteners and has a minimum value of 50mm. Stiffened overhangs require attachment of an angle or gutter to prevent flexing of the sheet edge.

Table 7.133 Maximum overhang

Product	Non-cyclonic		Cyclonic	
	Free edge	Stiffened	Free edge	Stiffened
Premier 300™	100	250	50	150

But in all cases limited to:

- Free edge: to 20% of the back (adjacent end) span
- Stiffened by gutter or angles: to 33% of the back (adjacent end) span

Fastener locations

Use one fastener per sheet at each support placed in top of the profile outboard of the interlock rib.

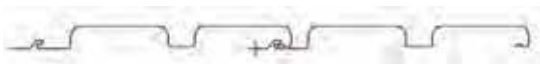

Accessories

Stramit can supply matching accessories for this profile including flashings, barges and fasteners.

Performance

The maximum span to suit the design variables can be determined from the following tables. For more information please refer to the How to use the cladding tables section on page 53.

Walls may be subject to impact loads, please refer to page 52 for recommendations.

Please note that Stramit's Premier 300™ architectural cladding performance depends upon the batten or purlin used and the fastener specified at the top of each table.

Table 7.134 Premier 300™ on 0.48mm batten

Maximum span (mm)

Fasteners:

10 x 25mm wafer head Type 17 screws

Number of fasteners		1/sheet		
Cladding thickness		0.55mm		
Span type		Internal	End	Equal
Wall	Wind load			
	N1	1750	1400	1550
	N2	1250	1000	1100
	N3	800	600	700
	N4	550	400	450
	N5			
	N6			

Table 7.135 Premier 300™ on 0.55mm batten

Maximum span (mm)

Fasteners:

10 x 25mm wafer head Type 17 screws

Number of fasteners		1/sheet		
Cladding thickness		0.55mm		
Span type		Internal	End	Equal
Wall	Wind load			
	N1	2100	1650	1850
	N2	1500	1200	1350
	N3	950	750	850
	N4	650	500	550
	N5			
	N6			

Table 7.136 Premier 300™ on 0.75mm batten/top hat

Maximum span (mm)

Fasteners:

10 x 25mm wafer head Type 17 screws

Number of fasteners		1/sheet		
Cladding thickness		0.55mm		
Span type		Internal	End	Equal
Wall	Wind load			
	N1	2100	1650	1850
	N2	1500	1200	1350
	N3	950	750	850
	N4	650	500	550
	N5			
	N6			

Table 7.137 Premier 300™ on 1.00mm purlin/top hatNON
CYCLONIC
AREAS 

Maximum span (mm)

Fasteners:

10 x 16mm wafer head SD screws

Number of fasteners		1/sheet		
Cladding thickness		0.55mm		
Span type		Internal	End	Equal
Wall	Wind load			
	N1	2200	1750	2200
	N2	2050	1600	1800
	N3	1300	1000	1150
	N4	850	650	750
	N5			
	N6			

Table 7.138 Premier 300™ on 1.20mm (and thicker) steel purlin and timber battensNON
CYCLONIC
AREAS 

Maximum span (mm)

Fasteners:

Steel: 10 x 16mm wafer head SD screws

Timber: 10 x 25mm wafer head Type 17 screws

Number of fasteners		1/sheet		
Cladding thickness		0.55mm		
Span type		Internal	End	Equal
Wall	Wind load			
	N1	2200	1750	2200
	N2	2200	1750	2200
	N3	1700	1350	1600
	N4	1200	950	1050
	N5			
	N6			

Table 7.139 Premier 300™ on 1.50mm (and thicker) steel purlin and timber battensCYCLONIC
AREAS 

Maximum span (mm)

Fasteners:

Steel: 10 x 16mm wafer head SD screws

Timber: 10 x 25mm wafer head Type 17 screws

Number of fasteners		1/sheet		
Cladding thickness		0.55mm		
Span type		Internal	End	Equal
Wall	Wind load			
	C1	600	450	500
	C2			
	C3			
	C4			

Sunset[®] Patio



The clean, glossy soffit lines of Stramit's Sunset[®] patio panel enhances any home with outdoor living areas.

- Unique design provides continuous surface for roof underside
- Interlocking panels provide strength and water-tight seal
- Can be supplied with beams and accessories
- Available with matching translucent panels

Mass

Table 7.140 Sheeting mass (kg/m² of roof area)

BMT (mm)	COLORBOND [®] steel* (Double-sided)
0.42	5.76

For more details on Sunset[®] patio panel, please refer to the Stramit Sunset[®] technical manual.

**The above values relate to COLORBOND[®] steel only and may be different for COLORBOND[®] Ultra steel, COLORBOND[®] Metallic steel and SUPERDURA[™] Stainless steel.*



Minimum roof slope

A minimum roof slope of only 1 degree is required to ensure effective drainage. However, because the self-weight of the panels causes natural curvature, a minimum slope of 2 degrees applies to spans greater than 4m.

Overhangs

The maximum overhang limits for both free edge and stiffened overhangs are shown below. An overhang is defined as the sheet projection past the last row of fasteners and has a minimum value of 50mm. Stiffened overhangs require attachment of an angle or gutter to prevent flexing of the sheet edge.

Table 7.141 Maximum overhang

Product	Non-cyclonic	
	Free edge	Stiffened
Sunset® patio panel	100	500

But in all cases limited to:

- Free edge: to 20% of the back (adjacent end) span
- Stiffened by gutter or angles: to 33% of the back (adjacent end) span

Fastener locations



Use 2 screws per panel fixed downwards at each support.
Extra screw required for edge panel fixed downwards.

Rivet fastening locations



Use 4 rivets per sheet fixed downwards.
Extra rivet required for edge sheets.

Accessories

Stramit can supply matching accessories for this profile including flashings, roll formed ridges, barges, fasteners and translucent sheet in either polycarbonate or fibreglass.

Performance

The maximum span to suit the design variables can be determined from the following tables. For more information please refer to the How to use the cladding tables section on page 53.

Please note that Stramit's Sunset® patio panel performance depends upon the batten or purlin used and the fastener specified at the top of each table.

Table 7.142 Sunset® patio panel on 1.00mm (and thicker) steel purlins and timber battens



Maximum span (mm)

Fasteners:

Steel: 10 x 25mm hex head SD screws with neoprene washers

Timber: 10 x 25mm hex head Type 17 screws with neoprene washers

Number of fasteners 2/sheet

Cladding thickness		0.42mm BMT							
		Application option A				Application option B			
Span type		Single	Double	Single + cantilever	Double + cantilever	Single	Double	Single + cantilever	Double + cantilever
Roof	Wind load								
	N1	2000	2100	1900	2200	4400	4000	3500	4300
	N2	2000	2100	1900	2200	3150	2900	2550	3150

Table 7.143 Sunset® patio panel on 1.00mm (and thicker) steel purlin



Maximum span (mm)

Fasteners:

Steel: 4.8mm diameter aluminium pop rivets

Number of fasteners 4/sheet

Cladding thickness		0.42mm BMT							
		Application option A				Application option B			
Span type		Single	Double	Single + cantilever	Double + cantilever	Single	Double	Single + cantilever	Double + cantilever
Roof	Wind load								
	N1	2000	2100	1900	2200	4500	4100	4400	4100
	N2	2000	2100	1900	2200	3850	3300	3800	3200

Table 7.144 Application variables

Application option	Deflection	Min Roof Slope	Foot Traffic
A	Controlled	1°	Light only
B	Acceptable	2°	None

Notes:

Acoustic Panel System



Stramit® acoustic panel system combines perforated standard profiles and 50mm SonoBatts® acoustic glass wool for effective sound absorption and style.

- Suits most architectural styles
- Range of profiles available, including Stramit® Corrugated roof and wall cladding, Stramit Longspan® roof and wall cladding, K-Panel® wall sheeting, Monoclad® wall sheeting, Monopanel® wall cladding and Premier 300™ architectural cladding
- Can be used vertically or horizontally
- Manufactured from high tensile steel for high strength and low weight; Premier 300™ architectural cladding is made from G300 steel
- Simple to install
- Exceptional sound reduction performance
- High sound absorption with Noise Reduction Coefficient (NRC) in excess of 0.93
- Tested in accordance with AS 1045 for sound absorption



Mass

Table 7.145 Approximate acoustic sheeting mass (kg/m² of area)

Profile	COLORBOND® steel*
Stramit Longspan® 0.42mm	4.3
Monoclad® 0.42mm	3.9
Corrugated 0.42mm	3.9
K-Panel® 0.42mm	3.6
Premier 300™ 0.55mm	5.1
Monopanel® 0.48mm	4.9

**The above values relate to COLORBOND® steel only and may be different for COLORBOND® Ultra steel, COLORBOND® Metallic steel and SUPERDURA™ Stainless steel.*

Perforations

Stramit standard perforations cover approximately 11% of the cladding surface. Holes are 2.4mm in diameter and are pitched symmetrically across the sheet. This layout gives the best balance between appearance, ease of installation, cladding performance and noise reduction.

Contact our technical services consultants if you require a different hole pattern.

Impact

For wall areas likely to be subject to human impact, sheeting spans should be reduced. Impact loads will vary considerably and these are not prescribed in Australian Standards. The sheeting spans should be adjusted dependent upon the exposure and importance of the application.

Fastener locations

All acoustic profiles should be installed using the same fastener patterns as shown in the original roof and wall cladding literature.

Accessories

Stramit can supply matching flashings and suitable fasteners for these applications.

Performance

The maximum spans for acoustic materials are found in the following table.

Walls may be subject to impact loads, please refer to page 52 for recommendations.

Table 7.146 Maximum spans of perforated cladding(mm)

Stramit profile	Ceiling applications	Non-impact areas of walls	Possible impact areas of walls
Stramit Longspan®	1200	1500	1200
Monoclad®	1200	1500	1200
Corrugated	1200	1200	900
K-Panel®	900	900	600
Premier 300™	900	900	600
Monopanel®	900	900	600

The NRC for Stramit Longspan® and Corrugated acoustic panels are given below.

Table 7.147 Noise reduction co-efficient (NRC)

Frequency (Hz)	Noise reduction co-efficient	
	Corrugated	Stramit Longspan®
100	0.60	0.48
200	0.81	0.74
300	0.95	0.97
400	0.88	0.88
500	1.03	0.98
600	0.96	0.98
700	0.99	1.05
800	1.06	1.14
900	1.07	1.10
1000	1.08	1.06
1100	1.02	1.10
1200	0.94	0.95
1300	0.78	0.84
1400	0.76	0.70
NRC	0.93	0.94

As a guide the following changes will affect the NRC values.

- Use of 75mm air gaps increase NRC by 0.02
- Use of 75mm SonoBatts® will increase NRC by 0.1
- MonoClad® or K-Panel® perforated sheets will reduce NRC by 0.1
- MonoPanel® or Premier 300™ perforated panels will reduce the NRC by 0.2
- Use of 50mm SonoBatts® reduces NRC by 0.2

For further details on the noise reduction properties of Stramit® acoustic panels please refer to the Stramit® Acoustic panel brochure.

In addition to the acoustic properties, the system also provides reasonable thermal performance. The 50mm SonoBatts® insulation provides a thermal resistance rating of approximately $R=1.5$.

Notes:

Uniguard™ Fire Resisting Wall System

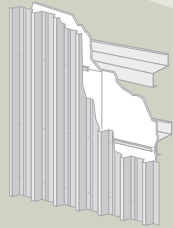
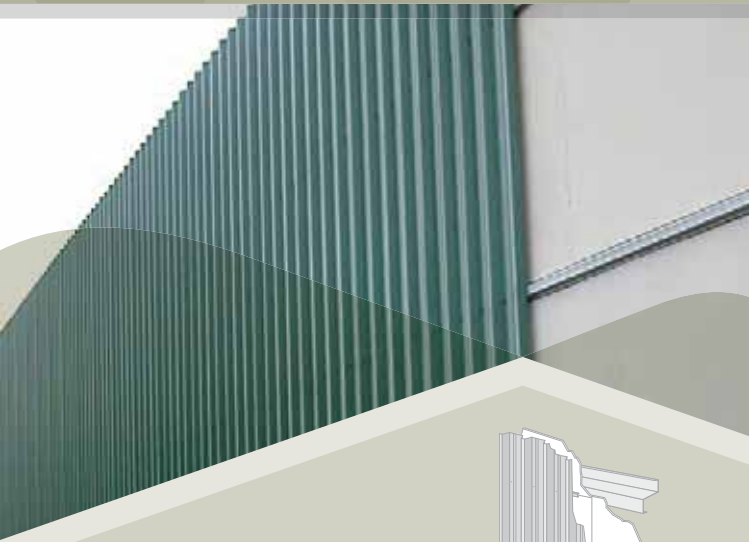

Uniguard™ fire resisting wall system's strength, simplicity and thermal insulation properties make it an ideal boundary wall solution.

- Ideal for single-storey industrial and commercial buildings Class 7b and 8 buildings of type C construction
- Complies with the requirements of the Building Code of Australia (BCA2004)
- Low-cost, quick installation with no need for specialist trades
- Versatile cladding options with a choice of Stramit® cladding profiles that can be either vertically or horizontally orientated
- Acoustic insulation, uniform internal wall appearance and easily painted if required

Note: Stramit's Uniguard™ fire resisting wall system is intended only for commercial and industrial wall cladding applications. Do not use for any other purpose.



AVAILABLE



NOT AVAILABLE



BCA fire resistance

Stramit's Uniguard™ fire resisting wall system provides a solution to the BCA requirements for external walls of buildings with floor areas less than 2000m² in Class 7b and Class 8 buildings (factories and warehouses) of type C construction.

The system conforms to the BCA requirements for an 'alternative solution' (i.e. that can be demonstrated to be equivalent to the deemed-to-satisfy provisions). Testing has shown that the Uniguard™ fire resisting wall system can meet the radiant heat flux exposure limits of Verification method CVI.

Full details of the testing, BCA alternative solution verification and system constraints and limitations are provided in the Warrington Fire Research Report numbers 40981B, 2275300-RPT01-Ver 1 and subsequent appended opinions.

Copies of the reports are available from your local Stramit office.

Boundaries

Stramit's Uniguard™ fire resisting wall system allows external walls to be built right up to the boundary, if practical considerations allow.

Allowance for gutters and downpipes must be made when considering the proximity of the wall to the boundary. Only the fire resisting wall sections need to be constructed using Uniguard™ fire resisting wall system. These walls are all within 3m of the boundary, and include side walls. The remaining walls may be constructed using a conventional Stramit® walling system.

System components

The external cladding can be Stramit's Monoclad®, Corrugated or Longspan® profiles in either ZINCALUME® steel or COLORBOND® steel.

Between the external cladding and the Promina® boards are galvanised spacers or top hats. These are normally held in permanent position by the cladding fasteners.

Promina®60 boards for the Uniguard™ fire resisting wall system are a standard size design, therefore checks for performance are not required.

Wall girts (or top hats) should be specified using the Stramit® Purlins, Girt & Bridging Product, or Top Hat technical manuals. Consideration should be given to the additional mass of the Promina®60 boards. Girts are spaced at 1200mm centres.

Accessories

To complete the Uniguard® fire resisting wall system, Stramit can provide complementary products including matching flashings, spacing battens, fasteners and Promaseal® Acrylic fire sealant to fill any gaps in the fire wall.

Performance

Fire resisting walls require certification by fire engineers so we recommend you refer to Stramit's Uniguard® technical manual to ensure full compliance with the system.

The external wall cladding should be designed to suit the required wind load category from *The Stramit Book of Answers*® using 1200mm equal spans.

Notes:



8. Insulation

to complement
the roof and wall

LIKE STRAMIT, FLETCHER INSULATION IS PART OF THE FLETCHER BUILDING GROUP OF COMPANIES, AND HAS BEEN SUPPLYING A WIDE RANGE OF SPECIALISED INSULATION PRODUCTS TO AUSTRALIA'S RESIDENTIAL, COMMERCIAL AND INDUSTRIAL SECTORS FOR MORE THAN 80 YEARS

Our close association enables us to work collaboratively to develop a total steel building product solution that meets your energy efficiency and acoustic design requirements.

Here are just a few of the Fletcher Insulation products we recommend using with our range of steel building products.

For more details on the full range of Fletcher Insulation products contact your local Stramit office, or contact Fletcher Insulation at insulation.com.au.

Permastop® Building Blanket

Foil backed for better insulation properties, this wide cover glasswool product provides excellent thermal insulation properties to keep the building cooler in summer and warmer in winter.

- Reduces energy usage, rain noise as well as the risk of condensation
- Satisfies the Bushfire Attack Level (BAL) requirements of 0-40 in roof applications, and 0-FZ in wall applications, all in accordance with AS 3959e
- Available in 3 different thicknesses of reflective foil laminate that comply with AS 4200.2 for metal roof duty selection
- Australian made with up to 80 percent recycled content

NCC requirements

As thermal performance and compliance to the NCC is dependant upon many variables including class of building, the climate zone the building is in, the structure, the direction of heat flow and the materials used, please refer to the Fletcher Insulation *Commercial & Roofing Insulation Product Selection Guide* for more information and product specifications.



Suitability

Permastop® Building Blanket is suitable for use with Stramit® roofing and wall cladding products. We recommend all installations using blanket thicker than 60mm use a spacer system to ensure the insulation levels are maintained at all supports.

Table 8.1 Material R-values*

Nominal blanket thickness (mm)	Material R-value (M ² K/W)*
55	R1.3
60	R1.4
75	R1.8
100	R2.3-R2.5
130	R3.0-R3.6

*The final R-value required for any project is determined by building location, design, air spaces and insulation. Please contact Fletcher Insulation to determine the product that best meets your project needs and complies with the National Construction Code.

Roof Rack® Insulation Spacer

This is the first insulation spacer in the market to be used with concealed metal deck roofs such as Stramit's Speed Deck Ultra® concealed fixed decking.

- Engineered to allow full recovery between the safety wire mesh and metal deck cladding
- Manufactured from high tensile galvanised steel for increased strength
- On-site installation made more efficient with 726mm rack length sheets matching width of Stramit's Speed Deck Ultra® concealed fixed decking sheets

Suitability

Roof Rack® Insulation Spacer can be used with Stramit's Speed Deck Ultra® concealed fixed decking in commercial buildings with roof pitches up to and including 22.5 degrees.



Thermal performance

Roof Rack® insulation spacer is available in two heights to suit most commonly used glasswool blanket thicknesses:

- 75mm Roof Rack® is generally recommended for use with 100mm thick Permastop® Building Blanket
- 100mm Roof Rack® is generally recommended for use with 130mm thick Permastop® Building Blanket

For Total R-value guidance relating to systems incorporated Roof Rack® go to insulation.com.au/fletcherspecpro.

NCC requirements

This product satisfies the National Construction Code's Section J energy efficiency provisions.

As thermal performance and compliance to the NCC is dependant upon many variables including class of building, the climate zone the building is in, the structure, the direction of heat flow and the materials used, please refer to the Fletcher Insulation *Commercial & Roofing Insulation Product Selection Guide* for more information and product specifications.

Roof Razor®

Insulation Spacer

Designed specifically for Australian metal roof construction, the Roof Razor® insulation spacer sits between the roof structure and the external member, creating a space for insulation to recover to its nominal thickness between purlins.

- Provides a wide and stable platform for roof installation directly above roof insulation
- Roof Razor® legs cut through the insulation blanket to give direct connection to the purlin, ensuring no vibration and movement
- Supplied in 1200mm lengths to match the width of Fletcher's Permastop® Building Blanket for easy and efficient installation

Suitability

The Roof Razor® insulation spacer is compatible with both pierced and concealed fixed roof cladding and can be used on roofs with a pitch up to and including 30 degrees.



Material specifications

This product is available in three heights to suit most commonly used blanket thicknesses:

- 60mm Roof Razor® is suitable for use with 75-80mm thick building blanket
- 85mm Roof Razor® is suitable for use with 100-120mm thick building blanket
- 115mm Roof Razor® is suitable for use with 130-145mm thick building blanket

NCC requirements

This product has been developed to satisfy the National Construction Code's Section J requirement that insulation must maintain its position and thickness between purlins.

RoofSafe® Safety Mesh

This mesh provides fall protection for roof installers and offers long-term fall protection for maintenance and repair workers.

- At 500–700 Mpa, it exceeds the minimum 450MPa tensile requirement, making it a stronger and safer mesh for workers
- Retains insulation materials and continues to provide protection after roof construction
- Complies with AS 4389 and all Australian States and Territory codes of practice for safe work on roofs

Suitability

This product is suitable for use in a range of commercial and industrial buildings.

NCC requirements

This product has been developed to satisfy the National Construction Code's Section J requirement that insulation must maintain its position and thickness between purlins.



Sisalation®

Foam Cell Multipurpose

A 3-in-1 multipurpose solution, this high quality foam product provides insulation, a thermal break and a vapour barrier.

- Reduces up to 95% of the sun's radiant heat, allowing cooler internal conditions in hot and humid climates
- Suitable for roofs with a BAL of O-40, and walls with a BAL of O-FZ
- Incorporates a 150mm overlap along one side edge to maximise coverage, minimise wastage and allow for sealed edge protection
- Complies with AS 3959

Suitability

This product is suitable for use in a range of commercial and residential buildings.

Thermal performance

Sisalation® Foam Cell Multipurpose complies with the requirements of AS/NZS 4859.1:2002, including Amendment 1.

NCC requirements

This product has been developed to satisfy the National Construction Code's Section J requirement that insulation must maintain its position and thickness between purlins.



Notes:



9. Rainwater Solutions

Lightweight, durable and available in styles and colours to suit any project design

THE STRAMIT® RANGE OF GUTTERS, FASCIA AND DOWNPIPES COMPLEMENT ANY HOME, SMALL OFFICE OR INDUSTRIAL BUILDING

Developed to suit local climatic conditions, the range includes traditional quad gutters, rectangular or square gutters as well as modernised half round gutters.

With matching downpipes using the same material finish, Stramit® rainwater products provide confidence in rainwater collection and distribution.

QUAD GUTTERS

Classic in design, Stramit® Quad gutter profiles work well with traditional or contemporary homes.

Features and benefits

- Available in a range of sizes to accommodate differing rainfall intensities, building sizes and budgets
- Overflow slots in most profiles are available on request
- Complete range of guttering accessories also available

Availability

QLD/NT



Quad 125



Quad 150



Quad 175



Stramit
Queenslander
Quad®

NSW/ACT



Hi Front Quad



Quad 115



Quad 125



InfinitiLine®

VIC/TAS/SA



Quad 115

WA



Trad-line™

SQUARE GUTTERS

Stramit® Square gutter range offers unique and stylish gutters for home improvements through to commercial projects.

Features and benefits

- Neat, square lines with plenty of water-carrying capacity
- Easy to install and cut and fold, with concealed brackets or snap clips
- Can come with slots to help stormwater overflow
- Matching barge or fascia capping for continuous sight lines

Availability

QLD/NT



M Pattern



S Pattern

NSW/ACT



Triline® HB



Triline® SB

VIC/TAS/SA



Eziflow



Fascia Gutter

WA



Easiline® Patio



Easiline® Domestic

All Stramit gutter and fascia profiles come complete with pre-made accessories including brackets, corners, downpipe astragals (straps) and drops. Please contact your local Stramit office for details.

HALF ROUND GUTTERS

Designed with exceptional drainage capacity the classic lines of Stramit® Half Round gutters enhance any Australian architectural design.

Features and benefits

- High water-carrying capacity
- Curved profile promotes self-cleaning
- Supports all fascia types in 150mm or 200mm sizes
- Available with external brackets only for half round profiles
- Snap clip to Stramit® Fascia on flatback profiles

Availability

In all Australian regions except WA



Half Round 150



Half Round 200



Flatback 150

NOTE: Other gutters, including O-Gee™ gutters and smaller Square or Quad gutters are available from Stramit. Please check with your local Stramit office for further details.

METAL FASCIA

The simple yet elegant lines of Stramit® Fascia products ensure your gutter solutions remain straight and true.

Features and benefits

- Made of steel and provides continuous support
- Suit any style of home across Australia, from heritage and traditional to the most modern of contemporary designs
- Specifically developed fascia solution to support Western Australian and Northern Territory gutters

Availability

QLD/NT/NSW/ACT/
VIC/TAS/SA



Stramit® Fascia

WA



Stramit
Strongline®
Fascia

NT



Stramit®
Fascia NT

Design data

All gutters, downpipes and fascia need to be designed to suit the application and/or local rainfall intensity. As a rule, downpipes should be placed before corners where water flows may be restricted. Downpipes should not be spaced further than 12m apart; gutter runs more than 20m long should include expansion joints to allow for thermal movement.

How to use the gutter and fascia design tables

1. Select the type and size of gutter required using the information presented in the Stramit® gutter tables developed specifically for your region.

Gutter selection table number	QLD/NT	NSW	VIC/SA/TAS	WA
	9.1	9.4	9.7	9.10

These tables provide data on each gutter shape so designers can consider gutter and downpipe size, support spacings and product mass. Provide gutter brackets or clips to suit the limits given in the table. Stramit has a range of downpipes to suit and match the gutter selected, and these are included in the tables listed above. Other sizes may be available, so please discuss with your local Stramit office.

2. Next, select the eave gutter drainage required using the information presented in the eave gutter drainage capacity tables developed specifically for your region.

Eave gutter drainage table number	QLD/NT	NSW	VIC/SA/TAS	WA
	9.2	9.5	9.8	9.11

These tables provide the maximum roof area per downpipe to suit the localities provided. Eave gutter drainage is determined by rainfall intensity and gutter size. To determine the number of downpipes required, divide the house roof plan area by the drainage result. The tables are based on roof plan areas and are suitable for roof pitches up to 23 degrees and are based on a 20-year Average Recurrence Interval (ARI).

3. Then select the principle gutter required using the overflow measures tables developed specifically for your region.

Overflow measures table number	QLD/NT	NSW	VIC/SA/TAS	WA
	9.3	9.6	9.9	N/A

All gutters must be designed for overflow to comply with the National Construction Code. Overflow performance is dependent on the length of roof run feeding the selected gutter and a rainfall intensity based on a 100-year ARI.

Low front gutters with 10m freeboard between the front of the gutter and the top of the fascia automatically comply. Other methods include unlined eaves or the use of back flashing to prevent water ingress.

Other gutters will require the use of BAT® clips to meet the overflow requirements. In some locations, larger (new) slots have been introduced to provide more drainage. Please note that the roof run length must include extra drainage from around roof penetrations.

4. Finally, determine the fascia spans required to best support the rainwater solution for your structure.

Stramit fascia table number	QLD/NT	NSW	VIC/SA/TAS	WA
	9.12	9.12	9.12	9.12



QLD/NT gutter design data tables

9.1 Stramit® gutters QLD and NT

Product	Cross sectional area (mm ²)		Mass (kg/m)		Maximum support spacings (mm)	Additional fascia height behind gutter (mm)*	Suggested downpipe size	
	Slotted	Unslotted	Unpainted	Painted			Round	Rectangular
Stramit Queenslander Quad®	7800	7900	1.07	1.08	1200		100	100x75
Quad 125*		5900	0.93	0.94	1000	7	100	100x75
Quad 150*		8500	1.04	1.05	1000	3	125	100x100
Quad 175*		14800	1.67	1.69	900	6	150	150x100
M pattern	7900	9100	1.27	1.28	1200		125	100x75
S Pattern	7900	9100	1.33	1.34	1200		125	100x75
Half Round 150	7700	7700	1.03	1.04	900		100	100x75
Half Round 200		13500	1.33	1.34	900		150	150x100
Flatback 150	7800	7800	1.03	1.04	900		100	100x75

* Low front gutters require 10mm above gutter front to top of fascia to comply with NCC overflow provisions.

9.2 Eave gutter drainage QLD and NT

Maximum roof area per downpipe (m²) for roofs up to 23° roof pitch

Northern Territory and Queensland	Locality	Rainfall intensity (mm/hr)	Gutter style			
			Stramit Queensland Quad®		Quad 125	
			Y	N	N	
Northern Territory	Darwin	233	34	35	24	
	Katherine	216	37	38	26	
	Alice Springs	166	46	48	34	
Far North Queensland	Cairns	229	35	36	25	
	Innisfail	248	31	33	23	
	Townsville	235	34	35	24	
	Charters Towers	198	40	41	28	
North West Queensland	Cloncurry	218	37	37	26	
	Mt Isa	199	40	41	28	
Central Queensland	Proserpine	233	34	35	24	
	Mackay	250	31	33	23	
	Rockhampton	229	34	35	24	
	Longreach	192	41	42	30	
South East Queensland	Bundaberg	265	30	30	21	
	Gympie	218	37	37	26	
	Noosa Heads	258	31	31	22	
	Brisbane	234	34	35	24	
	Southport	256	31	32	22	
South West Queensland	Toowoomba	203	39	40	28	
	Warwick	190	42	42	30	
	Goondiwindi	193	41	41	28	
	Charleville	178	44	45	31	

Gutter style





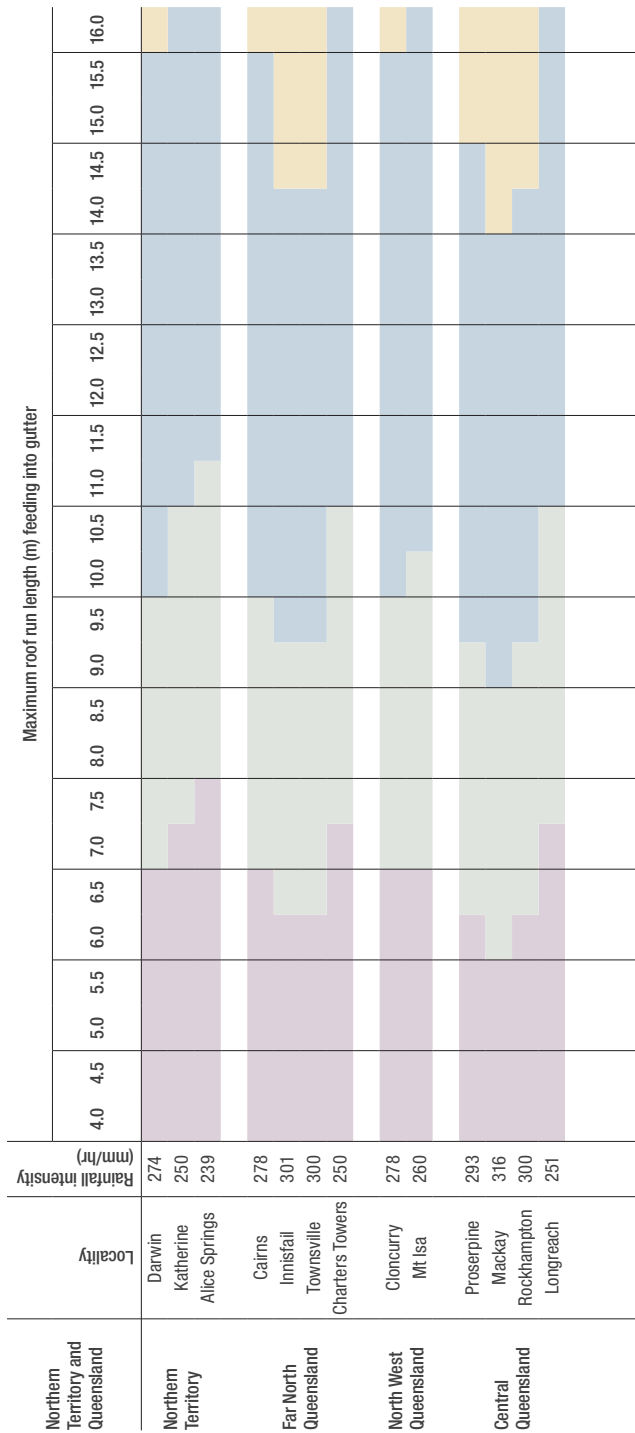

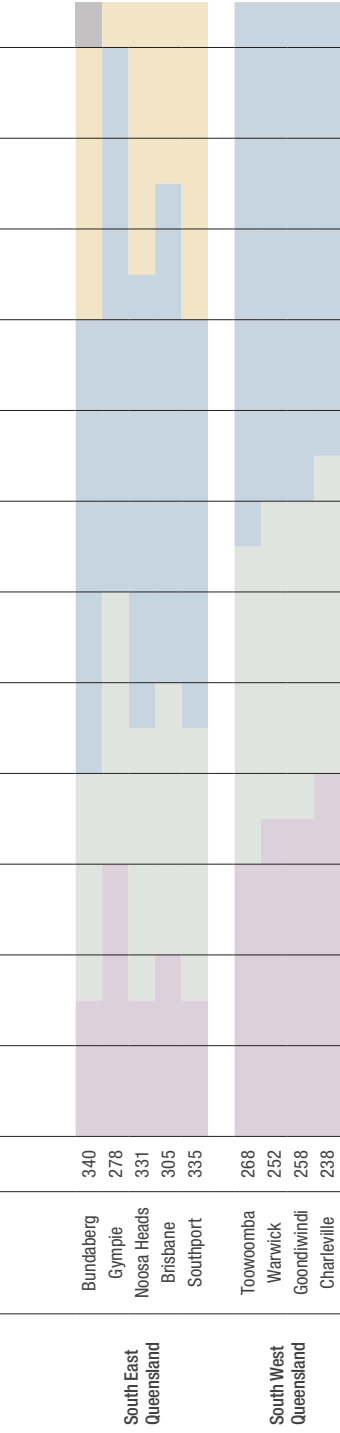
	Quad 150	Quad 175	M or S Pattern	Half Round 150	Half Round 200	Flatback 150			
Slotted									
	N	N	Y	N	Y	N	N	Y	N
	38	73	35	42	34	34	68	34	34
	41	83	37	44	36	36	75	37	37
	54	100	47	59	46	46	96	46	46
	39	77	36	42	34	34	69	35	35
	35	70	33	39	31	31	64	31	31
	38	73	35	42	34	34	68	34	34
	44	89	41	49	40	40	80	40	40
	41	82	37	44	35	35	73	37	37
	44	89	41	49	40	40	80	40	40
	38	73	35	42	34	34	68	34	34
	35	70	33	39	31	31	64	31	31
	38	73	35	42	34	34	68	34	34
	44	90	41	50	41	41	81	41	41
	33	66	30	36	29	29	60	30	30
	41	82	37	44	35	35	73	37	37
	34	68	31	37	30	30	61	31	31
	38	73	35	42	34	34	68	34	34
	34	70	32	38	30	30	62	31	31
	43	89	40	48	39	39	79	39	39
	44	90	41	50	41	41	81	41	41
	44	89	41	49	40	40	80	40	40
	49	100	45	53	44	44	89	44	44

9.3 Overflow measures Stramit Queensland Quad® QLD and NT





All other gutters require gutter spacers or BAT® clips to provide overflow protection.

Colour code	Max overflow volume (L/s/m)	Product
	0.50	'Old' slots or holes
	0.75	'New' holes
	1.20	Gutter spacer behind gutter
	1.50	BAT® clip behind gutter
	1.70	Gutter spacer and 'old' slots
	2.00	BAT® clip and 'old' slots

NSW/ACT gutter design data tables



9.4 Stramit® gutters NSW and ACT

Product	Cross sectional area (mm ²)		Mass (kg/m)		Maximum support spacings (mm)	Suggested downpipe size	
	Slotted	Unslotted	Unpainted	Painted		Round	Rectangular
Hi Front Quad	5200	5300	0.97	0.98	1200	90	100x50
Quad 115		4700	0.87	0.88	1200	90	100x50
Quad 125		6200	0.97	0.98	1200	90	100x50
Triline SB	7700	7700	1.33	1.34	1200	100	100x75
Triline HB	7700	7700	1.27	1.28	1200	100	100x75
Half Round 150	7700	7700	1.03	1.04	900	100	100x75
Half Round 200		13500	1.33	1.34	900	150	150x100
FlatBack 150	7800	7800	1.03	1.04	900	100	100x75

9.5 Eave gutter drainage NSW and ACT

Maximum roof area per downpipe (m²) for roofs up to 23° roof pitch

New South Wales and ACT	Locality	Rainfall intensity (mm/hr)	Gutter style										
			Infinitiline® Hi Front Quad		Quad 115	Quad 125	Triline HB and SB		Half Round 150		Half Round 200	Flatback 150	
			Slotted										
			Y	N	N	N	Y	N	Y	N	N	Y	N
North Coast NSW	Lismore	208	23	23	20	29	38	38	38	38	76	38	38
	Coffs Harbour	277	16	17	14	22	29	29	29	29	57	29	29
	Kempsey	216	22	23	19	27	35	35	36	36	75	37	37
	Port Macquarie	233	20	21	18	25	33	33	33	33	68	34	34
	Armidale	179	27	27	23	33	44	44	44	44	89	44	44
Middle Coast NSW	Maitland	191	25	26	22	32	42	42	42	42	84	42	42
	Newcastle	226	21	22	18	26	34	34	34	34	71	36	36
	Gosford	218	22	23	19	27	35	35	36	36	75	37	37
	Wyong	221	22	23	19	27	35	35	36	36	75	37	37
	Sydney	200	24	24	21	30	40	40	40	40	80	40	40
	Parramatta	163	29	30	26	37	48	48	48	48	98	48	48
	Riverstone	176	27	27	23	33	44	44	44	44	89	44	44
	Penrith	180	27	27	23	33	44	44	44	44	89	44	44
Western Slopes NSW	Lithgow	149	32	33	28	40	53	53	53	53	100	54	54
	Bathurst	125	38	39	34	46	62	62	62	62	100	62	62
	Orange	142	34	34	30	42	56	56	56	56	100	56	56
	Cowra	140	35	35	30	42	56	56	56	56	100	56	56
	Dubbo	167	29	30	25	37	48	48	48	48	98	48	48
	Forbes	151	32	33	28	40	53	53	53	53	100	54	54
Southern Highlands NSW	Bowral	161	30	31	26	38	49	49	49	49	100	49	49
	Mittagong	163	29	30	26	37	48	48	48	48	98	48	48
	Goulburn	121	38	39	35	46	62	62	62	62	100	62	62
South Coast NSW	Wollongong	217	22	23	19	27	35	35	36	36	75	37	37
	Nowra	179	27	27	23	33	44	44	44	44	89	44	44
	Batemans Bay	192	25	26	22	32	42	42	42	42	84	42	42
South West NSW/ACT	Canberra	143	33	34	29	42	56	56	56	56	100	56	56
	Wagga Wagga	154	31	31	27	39	51	51	51	51	100	51	51
	Albury	139	35	35	30	42	56	56	56	56	100	56	56
	Broken Hill	143	33	34	29	42	56	56	56	56	100	56	56

9.6 Overflow measures InfnitiLine® and Hi Front Quad NSW and ACT

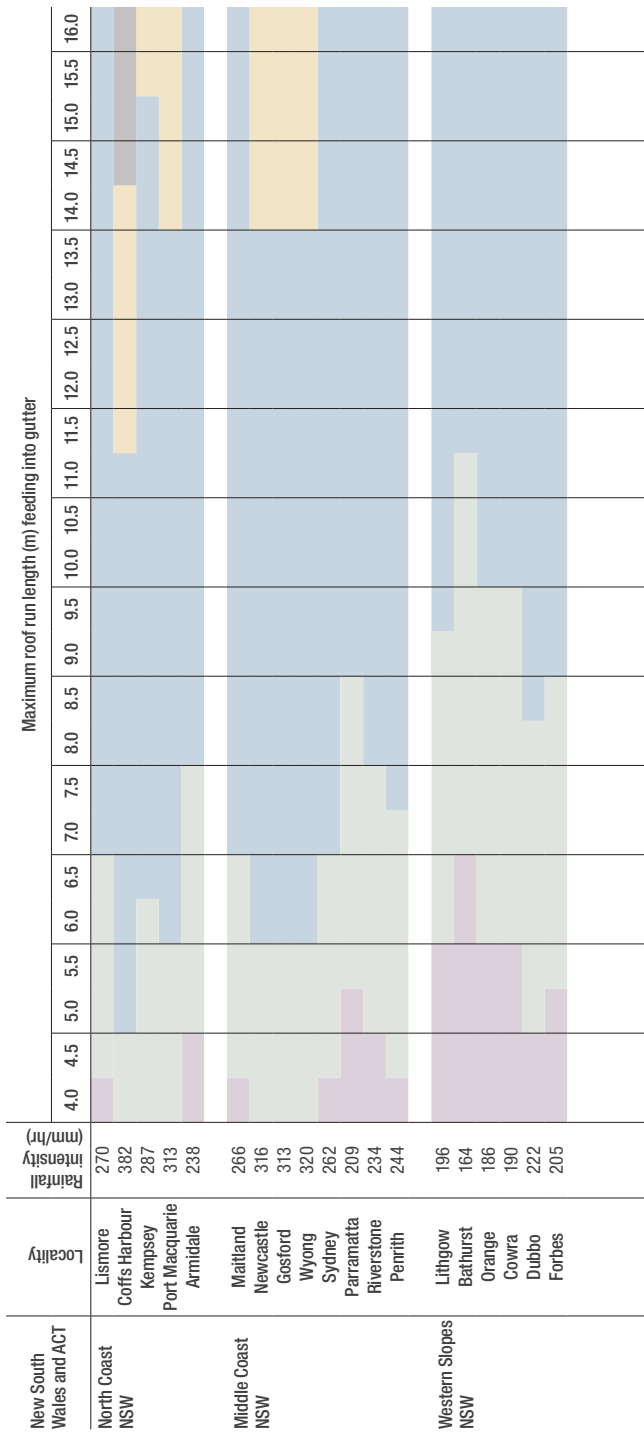

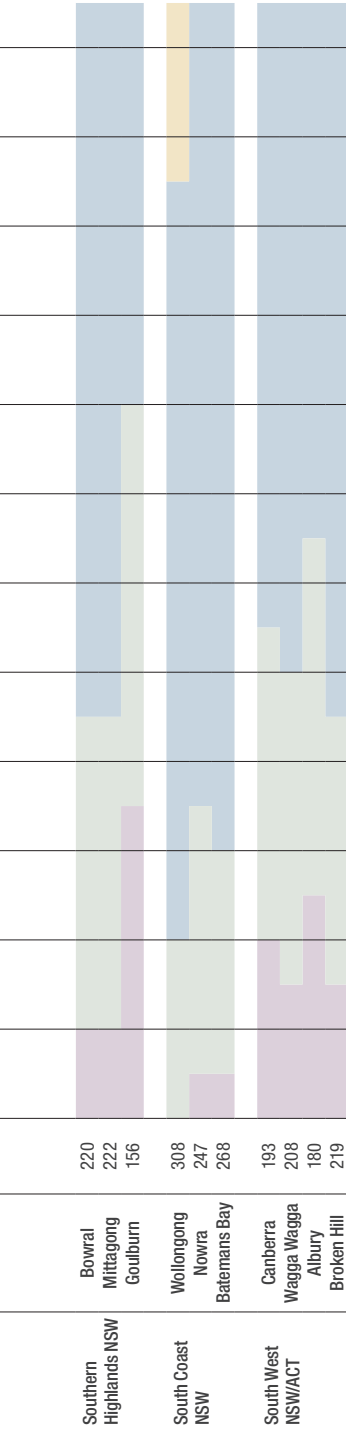

Colour code	Max overflow volume (L/s/m)	Product	Product
	0.30	InfinitiLine®	Hi-Front Quad
	0.50	Current holes	'Old' slots
	1.20	Current holes	'New' slots
	1.50	Current holes	Gutter spacer behind gutter
	1.70	Current holes	BAT® clip behind gutter
			Gutter spacer and 'new' slots

All other gutters require gutter spacers or BAT® clips to provide overflow protection.

VIC/SA/TAS gutter design data tables



9.7 Stramit® gutters VIC, SA and TAS

Product	Cross sectional area (mm ²)		Mass (kg/m)		Maximum support spacings (mm)	Suggested downpipe size	
	Slotted	Unslotted	Unpainted	Painted		Round	Rectangular
Quad 115	5200	5300	0.97	0.98	1000*	100	100x50
Easiflow	7900	8100	1.34	1.35	1200	125	100x75
Fascia Gutter	8400	9200	1.33	1.34	1200	125	100x75
O-Gee™		4700	1.18	1.19	1000	75	100x50

* 1200 when gutter has hook back





9.8 Eave gutter drainage VIC, SA and TAS

Maximum roof area per downpipe (m²) for roofs up to 23° roof pitch

Victoria, Tasmania and South Australia	Locality	Rainfall intensity (mm/hr)	Gutter style						
			Quad 115		Easiflow		Fascia Gutter		O-Gee™
			Slotted						
			Y	N	Y	N	Y	N	N
Victoria	Mildura	142	34	35	57	57	62	67	30
	Stawell	130	37	38	63	65	68	74	32
	Ballarat	131	37	38	63	65	68	74	32
	Melbourne	132	37	38	63	65	68	74	32
	Geelong	102	48	48	81	81	87	97	41
	Lakes Entrance	145	34	35	57	57	62	67	29
Tasmania	Launceston	90	54	55	91	91	98	98	47
	Burnie	128	38	38	63	64	69	77	33
	Hobart	85	54	55	91	91	98	98	50
South Australia	Port Augusta	133	37	38	63	65	68	74	32
	Adelaide	124	39	39	66	66	71	80	34
	Mt Gambier	103	48	48	81	81	87	97	41

9.9 Overflow measures Quad 115 and Easiflow gutter

Victoria, Tasmania and South Australia	Locality	Rainfall Intensity (mm/hr)	Maximum roof run length (m) feeding into gutter																									
			4.0	4.5	5.0	5.5	6.0	6.5	7.0	7.5	8.0	8.5	9.0	9.5	10.0	10.5	11.0	11.5	12.0	12.5	13.0	13.5	14.0	14.5	15.0	15.5	16.0	
Victoria	Mildura	218																										
	Stawell	186																										
	Ballarat	188																										
	Melbourne	187																										
	Geelong Lakes Entrance	144 198																										
Tasmania	Launceston	121																										
	Burnie	180																										
	Hobart	116																										
South Australia	Port Augusta	199																										
	Adelaide	184																										
	Mt Gambier	144																										

Colour code	Maximum Overflow volume (L/s/m)	Product Quad 115	Product Easiflow
	0.5	'New' slots	'New' slots
	0.8	Gutter Spacer behind gutter	'New' slots
	1.2	Gutter Spacer behind gutter	Gutter Spacer behind gutter
	0.5-1	BAT® clip behind gutter	BAT® clip behind gutter

All other gutters require gutter spacers or BAT® clips to provide overflow protection.

WA gutter design data tables



9.10 Stramit® gutters WA

Product	Cross sectional area (mm ²)		Mass (kg/m)		Maximum support spacings (mm)	Suggested rectangular downpipe size
	Unslotted	Slotted	Unpainted	Painted		
Trad-Line™	5200	5200	0.94	0.96	600	100x75
Easiline® Patio	6800		1.18	1.20	1000	100x75
Easiline® Domestic	6800		1.18	1.20	1200	100x50

9.11 Eave gutter drainage WA

Maximum roof area per downpipe (m²) for roofs up to 23° roof pitch

Western Australia	Locality	Rainfall intensity (mm/hr)	Gutter style			
			Trad-Line™	Easiline® Patio	Easiline® Domestic	
			Slotted			
			Y	N	N	N
North Coast	Broome	232	13	13	19	19
	Port Hedland	168	20	20	28	28
	Geraldton	138	24	24	34	34
South West	Perth	130	26	26	36	36
	Bunbury	148	22	22	32	32
	Albany	127	26	26	37	37

9.12 Overflow measures Trad-Line™

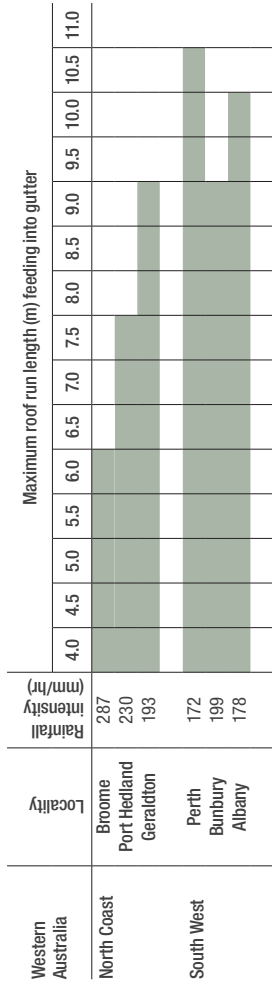

Colour code

█ Trad-Line™ with slots

For all other gutters, and for longer roof runs, please contact Stramit for more advice.

Fascia design data table



9.13 Stramit® fascias

Product	Mass (kg/m)		Maximum spans (mm)				Maximum wind category
	Unpainted	Painted	Separate tilt batten		Used as tilt batten		
	Unpainted	Painted	Internal	End	Internal	End	
Fascia	0.97	0.98	1500	1200	1200	900	N3
Fascia NT	0.97	0.98					
Strongline® fascia WA	1.49	1.51	1500	1200			N3

Please refer to chapter 17 for a worked example on how to use the gutter and fascia design tables.

Summary Checklist

- ✔ Ensure the correct spacing of fascia brackets and that all accessories are procured
- ✔ Select a gutter to suit the local supply and the required appearance
- ✔ Based on roof plan area determine the number and size of downpipes required
- ✔ Check for overflow provisions based on location and roof run length
- ✔ If necessary, select a larger gutter or overflow system
- ✔ Calculate the number of gutter brackets and other accessories required



10. Purlins and Girts

Construction
made easy

MANUFACTURED FROM HIGH TENSILE STEEL, STRAMIT'S PERFORMANCE-ENHANCED C&Z EXACTA® PURLINS AND GIRTS MAKE LIGHT WORK OF THE MOST COMMONLY USED SPANS IN CONSTRUCTION

They are supplemented with our traditional range of C&Z profiles, which are made to match existing or new project specifications.

Whichever product you elect to specify, you can be confident Stramit's range of purlins and girts will help create design efficiencies, reduce costs, overcome restricted access and ensure quick and easy installation.

Bridging

Bridging installed between the purlins and girts improves the performance of the system.

Stramit manufactures three bridging products, which have been developed for quick installation and optimum compatibility with Stramit's purlins and girts. These include:

- Boltless Bridging - suitable for purlin sizes between 100mm and 250mm
- Bolted Bridging
- Large Series Bridging

Stramit® boltless and bolted bridging systems are intended for installation with pre-installed purlins or girts. All Stramit® bridging products are suitable for use with Australian Institute of Steel Construction industry standard hole size and centres.

The Stramit® *Purlins Girts and Bridging Detailing and Installation Guide* has the full details on the bridging components and the installation details required for applications where the bridging is installed either up or down the roof slope.

Bridging design

Bridging provides resistance to purlin rotation during the installation of roof and wall sheeting. For this reason, a maximum bridging (or bridging to cleat) spacing of 20 x purlin depth, but no greater than 4000mm, is recommended. Failure to do so can lead to misaligned fastenings, causing additional stresses on the fasteners and roof sheeting. Excessive purlin rotation can be a safety hazard during construction.

Stramit therefore recommends that at least one row of bridging be used in each purlin span. Stramit's bridging is only designed to allow purlins and girts to resist wind loads once the sheeting has been attached. Purlins, girts and bridging should not be subjected to loading from stacked materials, even when sheeting is attached, or from lifting assemblies of framing.

Bridging used with girts may be subjected to compressive (or tensile) loading due to gravity during installation. These loads become cumulative with increasing wall height, unless a separation joint is included. The capacity of Stramit® Boltless Bridging, Bolted Bridging and Large Series Bridging to resist these loads is given in the *Stramit Purlins and Girts Product Technical Manual*.

Bolts

Bolting of Stramit® C&Z purlins or girts to cleats and at lapped joints should be by standard M12 grade 4.6 bolts unless the shear capacity of the bolt is exceeded as indicated in the design capacity tables. If so, bolts will need to be upgraded to grade 8.8 bolts.

For 300 series purlins use M16 or M16 grade 8.8 as indicated in the tables. Always use the correct size, positioning and grade of bolts, ensuring all bolts are securely tightened.

Downturn lips

All Stramit® C or Z purlins and girts may be available with downturn lips for special projects. Purlins of this shape cannot normally be lapped and are usually used in single or short double span construction. However, Stramit can supply lappable Zs, subject to inquiry, providing a unique section that offers strength and economy as well as a downturned lip.

Please contact your local Stramit office for details on availability. Remember to allow additional cleat length for clearance between the downturn lips and the support beam.

Fascia purlins

Fascia purlins (either specifically designed or Stramit C purlin) are normally subjected to lower loads and are usually restrained by sheeting attached to the top flange and lower lip.

However, should the fascia purlin support the wall girts via the fascia bridging system, ensure enough allowance is made to carry this extra load.

Holes

Stramit® C&Z purlins and girts are custom punched to meet project requirements. The standard hole size is 18x22mm for purlins to 250mm web depth, and 22mm diameter for larger purlins. The web hole centres are:

- C/Z 100 40mm
- C/Z 150 60mm
- C/Z 150 70mm (VIC & TAS)
- C/Z 200 110mm
- C/Z 250 160mm
- C/Z 300 210mm
- C/Z 350 210mm.

Lap lengths and design

Stramit generally recommends a lap length of 15% of the span. Lapped span design capacity tables (including continuous) are based on a 15% lap.

Special sizes

For special or large projects, Stramit can produce purlins outside the standard size range. These include:

- Web between 100–400mm
- Flange size between 30–130mm
- Lip size between 9–35mm (plus no lips)
- Thicknesses between 1.0–3.0mm
- Material strength between 300–550MPa
- Maximum strip width of 640mm

We can also calculate the performance of these special sections to suit project specifications. Please contact your local Stramit office for more details.

Length tolerance

All Stramit® C&Z purlins and girts sections are produced with a length tolerance of +0/-10mm.

How to use the purlin and girt tables

1. Determine the appropriate wind load category to suit the application.

This would be the same as the category selected for the roof and wall cladding design. All the load tables are calculated for roof loads as this is the worst design case. Designers are reminded that the roof loads used in this book, as shown in table 5.5, are for the building edges. The tables have been created using the lowest of the strength and serviceability (L/150) data. The tables offer a single span, a double (unlapped) span or a multiple lapped span option. Only Z sections can be lapped.

2. Determine the maximum span, or alternatively the maximum purlin spacing.

Designers can select from a range of span types and for all the available Stramit C&Z Exacta® sections. By ensuring the maximum purlin spacing is equal to the cladding span selected previously, designers will be able to select the most convenient or economic section.

3. Ensure the correct amount of bridging and the bolt size specified in the tables are used in the final design.

Bolt requirements are listed above the purlin table.

Please refer to chapter 17 for a worked example on how to use the purlin and girt tables.

Summary Checklist

- ✓ Check different sizes and thicknesses to obtain the best performance fit
- ✓ Utilise different amounts of bridging to increase purlin or girt performance
- ✓ Always use the correct fastener as indicated at the top of each table
- ✓ Ensure the purlin spacing is equal or greater than the cladding span designed previously
- ✓ For more information go to stramit.com.au/products/

Table 10.0 Purlin mass

Purlin size	Mass (kg/m)
10010	1.77
10012	2.11
10015	2.61
10019	3.29
15010EX	2.43
15012EX	2.90
15015EX	3.59
15019EX	4.51
15024EX	5.67
20012EX	3.63
20015EX	4.50
20019EX	5.74
20024EX	7.21
25015EX	5.18
25019EX	6.50
25024EX	8.17
30019EX	8.04
30024EX	10.20
30030EX	12.70
35019EX	9.68
35024EX	12.20
35030EX	15.20

Notes:

C&Z Exacta[®] purlins and girts



Exacta[®] purlin C



Exacta[®] purlin Z

- Capacity improvements of up to 18% on Stramit's conventional C&Z purlins and girts
- C sections are ideally suited to single or double span construction
- Z sections can be used for single spans and in unlapped and lapped continuous span construction
- High tensile steel for high strength and low weight
- Available in sizes 150mm, 200mm, 250mm, 300mm and 350mm
- Snap-in purlin boltless bridging system offers quick installation
- EX-Facta™ purlin design software offers quick design and cost savings



AVAILABLE



NOT AVAILABLE



Accessories

Stramit has a range of purpose made accessory brackets and connectors to complete the purlin system. These brackets allow easy connection to window frames, or any other structure.

Performance

The performance of Stramit's C&Z Exacta® purlins is found in the Stramit® *Exacta Purlin and Girt Technical Manual*. The maximum span or spacing to suit the design variables can be determined from the following tables.

The following tables allow designers to gain an easy and quick design solution for C&Z Exacta® purlins. Using the same roof and wall loadings as used in the earlier roof/wall section of *The Stramit Book of Answers*®, determine the purlin span and/or purlin spacing to match the roof and wall span.

Table 10.1 C/Z 100 purlin

All spans/spacings calculated for roof loads

Fasteners: Purlins connected to cleats with M12 x 30mm bolts

Wind load	Purlin Span (mm)	C and Z single span spacing (mm)				C and Z double span spacing (mm)	
		10010	10012	10015	10019	10010	10012
N1	2500	2200	2750	3000	3000	2200	2750
	3000	1550	1900	2400	3000	1550	1900
	3500	1050	1250	1600	2200	1100	1400
	4000	650	800	1100	1450	850	1050
	4500	500	650	800	1000	650	850
	5000	350	450	600	750	550	650
	5500		350	450	550	450	550
	6000			350	400		450
N2	2500	1600	2000	2600	3000	1600	2000
	3000	1100	1350	1750	2450	1100	1350
	3500	750	900	1150	1650	800	1000
	4000	450	600	800	1100	600	750
	4500	500	600	750	1000	500	600
	5000	350	450	550	750	400	500
	5500		350	450	550	300	400
	6000			350	400		300
N3	2500	1000	1250	1650	2300	1000	1250
	3000	700	850	1100	1550	700	850
	3500	450	600	750	1050	500	650
	4000	300	350	500	700	400	500
	4500	300	350	450	650	300	350
	5000		300	350	450		300
	5500				350		
	6000						
N4	2500	650	850	1100	1550	650	850
	3000	450	550	750	1050	450	550
	3500	300	400	500	700	350	400
	4000			350	450		300
	4500			300	450		
	5000				300		
	5500						
6000							
N5	2500	450	550	750	1050	450	550
	3000	300	400	500	700	300	400
	3500			300	450		
	4000				300		
	4500				300		
	5000						
	5500						
6000							
N6	2500	350	400	550	750	350	400
	3000		300	350	500		300
	3500				350		
	4000						
	4500						
	5000						
	5500						
6000							

Shaded areas require 1 row of Stramit bridging

Shaded areas require 2 rows of Stramit bridging

C and Z double span spacing (mm)		Z only triple lapped span spacing (mm)			
10015	10019	10010	10012	10015	10019
3000	3000	3000	3000	3000	3000
2500	3000	2450	3000	3000	3000
1800	2550	1800	2200	2850	3000
1400	1950	1350	1700	2100	2950
1100	1500	1000	1250	1600	2050
900	1250	750	900	1200	1500
700	1000	550	700	900	1150
600	850	450	550	700	850
2600	3000	2550	3000	3000	3000
1800	2500	1750	2150	2800	3000
1300	1800	1300	1600	2050	2900
1000	1400	1000	1200	1500	2150
800	1100	750	950	1250	1750
650	900	600	750	1000	1400
500	750	500	650	800	1150
450	600	400	500	650	850
1650	2300	1600	2000	2600	3000
1150	1600	1100	1400	1800	2500
850	1150	800	1000	1300	1850
650	900	600	750	950	1350
500	700	500	600	800	1100
400	550	400	500	650	900
300	450	300	400	500	700
	400		300	400	550
1100	1550	1050	1350	1750	2450
750	1050	750	900	1200	1700
550	750	550	650	900	1250
400	600	400	500	650	900
300	450	300	400	500	750
	350		300	400	600
	300			350	500
					350
750	1050	700	900	1150	1650
500	700	500	600	800	1150
350	500	350	450	600	850
	400		350	400	600
	300			350	500
					400
					300
550	750	550	650	850	1200
350	500	350	450	600	850
	400		300	450	600
	300			300	450
					350
					300

Table 10.2 C/Z 100 purlin

All spans/spacings calculated for roof loads

Fasteners: Purlins connected to cleats with M12 x 30mm bolts

Wind load	Purlin span (mm)	C and Z single span spacing (mm)				C and Z double span spacing (mm)	
		10010	10012	10015	10019	10010	10012
C1	2500	800	1000	1300	1850	800	1000
	3000	550	700	850	1250	550	700
	3500	350	450	600	800	400	500
	4000		300	400	550	300	350
	4500		300	350	550		300
	5000			300	400		
	5500				300		
6000				250			
C2	2500	550	650	850	1200	550	650
	3000	350	450	600	850	350	450
	3500		300	400	550		350
	4000				350		
	4500				350		
	5000						
	5500						
6000							
C3	2500	350	450	600	800	350	450
	3000		300	400	550		300
	3500				350		
	4000						
	4500						
	5000						
	5500						
6000							
C4	2500		300	450	600		300
	3000			300	400		
	3500						
	4000						
	4500						
	5000						
	5500						
6000							

 Shaded areas require 1 row of Stramit bridging

 Shaded areas require 2 rows of Stramit bridging

C and Z double span spacing (mm)		Z only triple lapped span spacing (mm)			
10015	10019	10010	10012	10015	10019
1300	1850	1300	1600	2050	2900
900	1250	900	1100	1450	2000
650	900	650	800	1050	1450
500	700	500	600	750	1100
400	550	400	450	600	900
300	450	300	400	500	700
	350		300	400	550
	300			300	450
850	1200	850	1050	1400	1950
600	850	600	750	950	1350
450	600	400	550	700	1000
350	450	300	400	500	700
	350		300	400	600
	300			350	450
					400
					300
600	800	550	700	950	1300
400	550	400	500	650	900
300	400	300	350	450	650
	300			350	500
					400
					300
450	600	400	500	700	950
300	400	300	350	450	650
	300			350	500
					350
					300

Table 10.3 C/Z 150 Exacta® purlin

All spans/spacings calculated for roof loads

Fasteners: Purlins connected to cleats with M12 x 30mm bolts

Values in **bold italics** require Grade 8.8 bolts

Wind load	Purlin span (mm)	C and Z single span spacing (mm)					C and Z double span spacing (mm)	
		15010EX	15012EX	15015EX	15019EX	15024EX	15010EX	15012EX
N1	3000	2850	3000	3000	3000	3000	2150	3000
	3500	2100	2600	3000	3000	3000	1700	2550
	4000	1600	1950	2550	3000	3000	1400	1950
	4500	1250	1550	1950	2700	3000	1200	1550
	5000	900	1200	1450	2000	2600	1000	1250
	5500	700	900	1150	1500	1950	850	1050
	6000	500	650	850	1150	1500	700	850
	6500	450	550	750	950	1200	600	750
	7000	350	450	600	750	950	500	600
	7500	300	350	450	600	800	450	550
	8000		300	400	500	650		
8500			300	400	500			
9000				350	450			
N2	3000	2050	2550	3000	3000	3000	1550	2300
	3500	1500	1850	2400	3000	3000	1250	1800
	4000	1150	1400	1850	2550	3000	1000	1400
	4500	900	1100	1400	1950	2450	850	1100
	5000	650	850	1050	1450	1850	700	900
	5500	500	650	800	1100	1400	600	750
	6000	350	450	600	800	1050	500	600
	6500	400	500	650	950	1200	400	500
	7000	350	450	550	750	950	350	450
	7500	300	350	450	600	800	300	400
	8000		300	350	500	650		
8500			300	400	500			
9000				350	450			
N3	3000	1300	1600	2100	2900	3000	1000	1500
	3500	950	1200	1550	2150	2900	800	1150
	4000	750	900	1150	1600	2150	650	900
	4500	550	700	900	1250	1550	550	700
	5000	400	550	650	900	1200	450	550
	5500	300	400	500	700	900	350	450
	6000		300	400	500	650	300	400
	6500		300	400	600	750		300
	7000		300	350	500	600		300
	7500			300	400	500		
	8000				300	400		
8500					350			
9000					300			
N4	3000	850	1100	1400	1950	2650	650	1000
	3500	650	800	1000	1400	1950	500	750
	4000	500	600	750	1100	1400	400	600
	4500	350	450	600	800	1050	350	450
	5000		350	450	600	800	300	350
	5500			350	450	600		300
	6000				350	450		
	6500				400	500		
	7000				300	400		
	7500					350		
	8000							
8500								
9000								
N5	3000	600	700	950	1300	1800	450	650
	3500	400	550	700	950	1300	350	500
	4000	300	400	500	750	950	300	400
	4500		300	400	550	700		300
	5000			300	400	500		
	5500				300	400		
	6000					300		
	6500					350		
	7000							
	7500							
	8000							
8500								
9000								
N6	3000	450	550	700	950	1350	300	500
	3500	300	400	500	700	950		350
	4000		300	400	550	700		300
	4500			300	400	500		
	5000				300	400		
	5500					300		
	6000							
	6500							
	7000							
	7500							
	8000							
8500								
9000								

C and Z double span spacing (mm)			Z only triple lapped span spacing (mm)				
15015EX	15019EX	15024EX	15010EX	15012EX	15015EX	15019EX	15024EX
3000	3000	3000	2850	3000	3000	3000	3000
3000	3000	3000	2350	3000	3000	3000	3000
2550	3000	3000	2000	3000	3000	3000	3000
2000	2800	3000	1700	2650	3000	3000	3000
1600	2250	3000	1500	2150	2700	3000	3000
1350	1850	2550	1300	1750	2150	2950	3000
1100	1550	2150	1050	1400	1700	2300	2950
950	1350	1800	950	1150	1500	1950	2450
800	1150	1550	750	950	1200	1550	1950
700	1000	1350	600	750	950	1250	1600
			500	600	800	1050	1300
			400	500	650	850	1100
			350	450	550	700	900
3000	3000	3000	2050	3000	3000	3000	3000
2400	3000	3000	1700	2700	3000	3000	3000
1850	2550	3000	1450	2250	3000	3000	3000
1450	2000	2750	1250	1900	2500	3000	3000
1150	1600	2200	1050	1550	1950	2700	3000
950	1350	1850	950	1250	1550	2100	2700
800	1100	1550	750	1000	1200	1650	2150
700	950	1300	750	900	1200	1650	2100
600	800	1150	650	800	1000	1400	1750
500	700	1000	500	700	850	1150	1450
			450	550	700	950	1250
			350	500	600	800	1050
			300	400	500	700	900
2100	2900	3000	1300	2100	3000	3000	3000
1550	2150	2900	1100	1700	2650	3000	3000
1150	1600	2250	900	1450	2000	2800	3000
900	1300	1750	800	1200	1600	2200	2850
750	1050	1400	700	1000	1250	1750	2200
600	850	1150	600	800	950	1350	1700
500	700	950	500	650	750	1050	1350
450	600	850	450	600	750	1050	1350
350	500	700	400	500	600	850	1100
300	450	600	350	450	500	750	950
				350	450	600	800
				300	350	500	650
					300	450	550
1400	1950	2650	850	1400	2300	3000	3000
1000	1400	1950	700	1150	1750	2450	3000
750	1100	1500	600	950	1350	1850	2500
600	850	1150	500	800	1050	1450	1900
500	700	950	450	650	800	1150	1450
400	550	800	400	550	650	900	1150
350	450	650	300	400	500	700	900
300	400	550	300	400	500	700	900
	350	450		300	400	600	750
	300	400			350	500	600
					300	400	500
						350	450
						300	350
950	1300	1800	600	950	1550	2250	3000
700	950	1300	500	750	1200	1650	2300
500	750	1000	400	650	900	1250	1700
400	550	800	350	550	700	1000	1300
300	450	650	300	450	550	750	1000
	350	500		350	450	600	750
	300	450			350	450	600
		350			350	450	600
		300				400	500
						300	400
							350
							300
700	950	1350	400	700	1150	1650	2300
500	700	950	350	550	900	1200	1700
400	550	750	300	450	650	950	1250
300	400	600		400	500	750	950
	350	450		300	400	550	750
		400			300	450	550
		300				350	450
						300	350
							300

Shaded areas require 1 row of Stramit bridging

Shaded areas require 2 rows of Stramit bridging

Table 10.4 C/Z 150 Exacta® purlin

All spans/spacings calculated for roof loads

Fasteners: Purlins connected to cleats with M12 x 30mm bolts

Values in **bold italics** require Grade 8.8 bolts

Wind load	Purlin span (mm)	C and Z single span spacing (mm)					C and Z double span spacing (mm)	
		15010EX	15012EX	15015EX	15019EX	15024EX	15010EX	15012EX
C1	3000	1050	1300	1650	2300	3000	750	1200
	3500	750	950	1200	1700	2350	600	900
	4000	600	700	900	1300	1700	500	700
	4500	450	550	700	1000	1250	400	550
	5000	300	400	550	750	950	350	450
	5500		300	400	550	700	300	350
	6000			300	400	550		300
	6500			350	450	600		
	7000				350	500		
	7500				300	400		
	8000					300		
	8500							
9000								
C2	3000	700	850	1100	1550	2150	500	800
	3500	500	600	800	1150	1550	400	600
	4000	400	450	600	850	1150	350	450
	4500	300	350	450	650	850		350
	5000		300	350	500	600		300
	5500				350	450		
	6000				250	350		
	6500				300	400		
	7000					300		
	7500							
	8000							
	8500							
9000								
C3	3000	450	550	750	1050	1450	350	500
	3500	350	400	550	750	1050		400
	4000		300	400	600	750		300
	4500			300	450	550		
	5000				300	400		
	5500					300		
	6000							
	6500							
	7000							
	7500							
	8000							
	8500							
9000								
C4	3000	350	400	550	750	1050		400
	3500		300	400	550	750		300
	4000			300	400	550		
	4500				300	400		
	5000					300		
	5500							
	6000							
	6500							
	7000							
	7500							
	8000							
	8500							
9000								

Shaded areas require 1 row of Stramit bridging

Shaded areas require 2 rows of Stramit bridging

C and Z double span spacing (mm)			Z only triple lapped span spacing (mm)				
15015EX	15019EX	15024EX	15010EX	15012EX	15015EX	15019EX	15024EX
1650	2300	3000	1050	1700	2750	3000	3000
1200	1700	2350	850	1350	2100	2900	3000
900	1300	1750	750	1150	1600	2250	3000
700	1000	1400	600	950	1250	1750	2250
600	800	1150	550	800	1000	1350	1750
500	650	950	450	650	750	1050	1350
400	550	750	400	500	600	850	1100
350	500	650	350	450	600	800	1050
300	400	550	300	400	500	700	900
	350	500		350	400	600	750
				300	350	500	600
					300	400	550
						350	450
1100	1550	2150	700	1150	1850	2700	3000
800	1150	1550	550	900	1400	1950	2700
600	850	1200	500	750	1050	1500	2000
500	700	950	400	650	850	1150	1500
400	550	750	350	500	650	900	1150
300	450	600	300	400	500	700	900
	350	500		350	400	550	700
	300	450		300	400	550	700
		350			300	450	600
		300				400	500
						300	400
							350
							300
750	1050	1450	450	750	1250	1800	2500
550	750	1050	400	600	950	1300	1800
400	600	800	300	500	700	1000	1350
300	450	650		400	550	800	1000
	350	500		350	450	600	800
	300	400		300	350	500	600
		350				350	500
		300				350	450
						300	400
							350
550	750	1050	350	550	900	1350	1850
400	550	750	250	450	700	950	1350
300	400	600	250	350	550	750	1000
	350	450		300	400	600	750
		350			300	450	600
		300				350	450
							350
							350
							300

Table 10.5 C/Z 200 Exacta® purlin - Part 1

All spans/spacings calculated for roof loads

Fasteners: Purlins connected to cleats with M12 x 30mm bolts

Values in ***bold italics*** require Grade 8.8 bolts

Underlined values require M16 Grade 8.8 bolts

Wind load	Purlin span (mm)	C and Z single span spacing (mm)				C and Z double span spacing (mm)	
		20012EX	20015EX	20019EX	20024EX	20012EX	20015EX
N1	4000	2850	3000	3000	3000	2050	3000
	4500	2250	2900	3000	3000	1700	2800
	5000	1800	2350	3000	3000	1500	2350
	5500	1450	1950	2700	3000	1300	1950
	6000	1150	1550	2150	2950	1100	1650
	6500	900	1200	1750	2300	1000	1400
	7000	700	950	1400	1800	850	1200
	7500	550	750	1100	1400	750	1050
	8000	450	600	850	1100		
	8500	500	700	950	1200		
	9000	450	600	800	1000		
	9500	350	500	650	850		
	10000		400	550	750		
	10500		350	500	600		
	11000			400	550		
11500			350	450			
12000				400			
N2	4000	2050	2650	3000	3000	1450	2400
	4500	1600	2100	3000	3000	1250	2000
	5000	1300	1700	2500	3000	1050	1700
	5500	1050	1400	1950	2700	900	1400
	6000	800	1100	1550	2100	800	1150
	6500	650	850	1250	1650	700	1000
	7000	500	650	1000	1300	600	850
	7500	400	500	750	1000	550	750
	8000	300	400	600	800		
	8500	400	550	800	1050		
	9000	350	450	650	900		
	9500	300	400	600	750		
	10000		350	500	650		
	10500		300	400	550		
	11000			350	450		
11500			300	400			
12000				300			
N3	4000	1300	1700	2500	3000	950	1550
	4500	1000	1350	1950	2700	800	1250
	5000	800	1100	1600	2200	650	1050
	5500	650	900	1250	1700	600	900
	6000	500	700	1000	1350	500	750
	6500	400	550	800	1050	450	650
	7000	300	400	650	800	400	550
	7500		300	500	650	350	450
	8000			350	500		
	8500		350	500	700		
	9000		300	400	550		
	9500			350	500		
	10000			300	400		
	10500				350		
	11000				300		
11500							
12000							

Table values continued on next page



- Shaded areas require 1 row of Stramit bridging
- Shaded areas require 2 rows of Stramit bridging

C and Z double span spacing (mm)		Z only triple lapped span spacing (mm)			
20019EX	20024EX	20012EX	20015EX	20019EX	20024EX
3000	3000	2700	3000	3000	3000
3000	3000	2350	3000	3000	3000
3000	3000	2050	3000	3000	3000
2850	3000	1850	3000	3000	3000
2400	3000	1650	2750	3000	3000
2000	2800	1450	2350	3000	3000
1750	2400	1300	1900	2650	3000
1500	2100	1150	1600	2250	3000
		950	1300	1850	2450
		1000	1350	1900	2450
		900	1200	1600	2050
		750	1000	1350	1750
		650	850	1150	1500
		550	750	1000	1300
		500	650	850	1100
		450	550	750	950
		350	500	650	850
3000	3000	1950	3000	3000	3000
3000	3000	1700	3000	3000	3000
2500	3000	1500	2600	3000	3000
2050	2850	1300	2250	3000	3000
1700	2400	1150	1950	2850	3000
1450	2050	1050	1700	2350	3000
1250	1750	950	1400	1900	2650
1100	1500	850	1150	1600	2150
		700	950	1350	1800
		700	1000	1400	1950
		650	850	1200	1700
		550	750	1050	1450
		500	650	900	1300
		400	550	800	1100
		350	500	700	950
		300	450	650	850
		300	350	550	700
2500	3000	1250	2250	3000	3000
1950	2700	1100	1900	3000	3000
1600	2200	950	1650	2700	3000
1300	1800	850	1450	2200	3000
1100	1500	750	1250	1800	2500
900	1300	650	1050	1500	2050
800	1100	600	900	1200	1700
700	950	550	700	1000	1400
		450	600	850	1150
		450	600	900	1250
		400	550	750	1100
		350	500	650	950
		300	400	600	800
			350	500	700
			300	450	600
				400	550
				350	450

Table 10.5 C/Z 200 Exacta® purlin - Part 2

Continued from previous page

Wind load	Purlin span (mm)	C and Z single span spacing (mm)				C and Z double span spacing (mm)	
		20012EX	20015EX	20019EX	20024EX	20012EX	20015EX
N4	4000	850	1150	1650	2300	600	1000
	4500	700	900	1300	1800	500	850
	5000	550	700	1050	1450	450	700
	5500	450	600	850	1150	400	600
	6000	350	450	650	900	350	500
	6500		350	500	700	300	400
	7000			400	550		350
	7500			300	400		300
	8000				300		
	8500			300	450		
	9000				400		
	9500				300		
	10000						
	10500						
11000							
11500							
12000							
N5	4000	600	750	1100	1550	400	700
	4500	450	600	900	1250	350	550
	5000	350	500	700	1000	300	450
	5500	300	400	550	750		400
	6000		300	450	600		350
	6500			350	450		
	7000				350		
	7500				300		
	8000						
	8500				300		
	9000						
	9500						
	10000						
	10500						
11000							
11500							
12000							
N6	4000	400	550	800	1150	300	500
	4500	350	450	650	900		400
	5000		350	500	750		350
	5500		300	400	550		300
	6000			300	450		
	6500				350		
	7000						
	7500						
	8000						
	8500						
	9000						
	9500						
	10000						
	10500						
11000							
11500							
12000							

-  Shaded areas require 1 row of Stramit bridging
-  Shaded areas require 2 rows of Stramit bridging

C and Z double span spacing (mm)		Z only triple lapped span spacing (mm)			
20019EX	20024EX	20012EX	20015EX	20019EX	20024EX
1650	2300	850	1500	2700	3000
1300	1800	700	1250	2250	3000
1050	1450	600	1100	1800	2500
850	1200	550	950	1500	2050
700	1000	500	850	1200	1700
600	850	450	700	1000	1400
500	750	400	600	800	1100
450	650	350	450	700	900
		300	400	550	750
		300	400	600	850
			350	500	700
			300	450	600
				400	550
				350	450
				300	400
					350
					300
1100	1550	550	1000	1800	2650
900	1250	500	850	1500	2100
700	1000	400	750	1200	1700
600	800	350	650	1000	1400
500	700	350	550	800	1150
400	600	300	450	650	950
350	500		400	550	750
300	450		300	450	600
				400	500
				400	550
				350	500
				300	400
					350
					300
800	1150	400	750	1350	1950
650	900	350	650	1100	1550
500	750	300	550	900	1250
400	600		450	750	1050
350	500		400	600	850
300	400		350	500	700
	350		300	400	550
	300			350	450
				300	350
				300	400
					350
					300

Table 10.6 C/Z 200 Exacta® purlin

All spans/spacings calculated for roof loads

Fasteners: Purlins connected to cleats with M12 x 30mm bolts

Values in ***bold italics*** require Grade 8.8 bolts

Underlined values require M16 Grade 8.8 bolts

Wind load	Purlin span (mm)	C and Z single span spacing (mm)				C and Z double span spacing (mm)	
		20012EX	20015EX	20019EX	20024EX	20012EX	20015EX
C1	4000	1050	1350	2000	2750	750	1200
	4500	800	1050	1550	2150	600	1000
	5000	650	850	1250	1750	550	850
	5500	500	700	1000	1350	450	700
	6000	400	550	800	1050	400	600
	6500	300	450	650	850	350	500
	7000		350	500	650	300	400
	7500			400	500		350
	8000			300	400		
	8500			400	550		
	9000			350	450		
	9500			300	400		
	10000				300		
	10500						
	11000						
11500							
12000							
C2	4000	700	900	1300	1850	500	800
	4500	550	700	1050	1450	400	650
	5000	450	550	850	1150	350	550
	5500	350	450	650	900	300	450
	6000		350	500	700		400
	6500		300	400	550		350
	7000			350	450		300
	7500				350		
	8000						
	8500				350		
	9000				300		
	9500						
10000							
10500							
11000							
C3	4000	450	600	900	1250	300	550
	4500	350	450	700	1000		450
	5000	300	400	550	800		350
	5500		300	450	600		300
	6000			350	500		
	6500				350		
	7000				300		
	7500						
	8000						
	8500						
	9000						
9500							
10000							
C4	4000	350	450	650	900		400
	4500		350	500	700		350
	5000			400	600		
	5500			300	450		
	6000				350		
	6500						
	7000						
	7500						
	8000						
8500							

Shaded areas require 1 row of Stramit bridging

Shaded areas require 2 rows of Stramit bridging

C and Z double span spacing (mm)		Z only triple lapped span spacing (mm)			
20019EX	20024EX	20012EX	20015EX	20019EX	20024EX
2000	2750	1000	1800	3000	3000
1550	2150	850	1500	2650	3000
1250	1750	750	1300	2150	3000
1050	1450	650	1150	1750	2450
850	1200	600	1000	1450	2000
750	1050	550	850	1200	1650
650	900	450	700	950	1350
550	750	400	550	800	1100
		350	450	700	900
		350	500	700	1000
		300	450	600	850
			400	550	750
			350	450	650
			300	400	550
				350	500
				300	400
					350
					300
1300	1850	650	1200	2150	3000
1050	1450	550	1000	1800	2500
850	1150	500	850	1450	2000
700	950	450	750	1200	1650
550	800	400	650	950	1350
500	700	350	550	800	1100
400	600	300	450	650	900
350	500		350	550	750
			300	450	600
			300	450	650
			300	400	550
				350	500
				300	400
					350
					300
900	1250	450	800	1450	2150
700	1000	400	700	1200	1700
550	800	350	600	950	1350
450	650	300	500	800	1100
400	550		450	650	900
300	450		350	550	750
	400		300	450	600
	350			350	500
				300	400
				300	450
					400
					350
					300
650	900	300	600	1050	1550
500	700		500	900	1250
400	600		450	700	1000
350	450		350	600	800
300	400		300	450	650
	350			400	550
	300			300	450
					350
					300
					300

Table 10.7 C/Z 250 Exacta® purlin - Part 1

All spans/spacings calculated for roof loads

Fasteners: Purlins connected to cleats with M12 x 30mm bolts

Values in ***bold italics*** require Grade 8.8 bolts

Underlined values require M16 Grade 8.8 bolts

Wind load	Purlin span (mm)	C and Z single span spacing (mm)			C and Z double span spacing (mm)		
		25015EX	25019EX	25024EX	25015EX	25019EX	25024EX
N1	5000	3000	3000	3000	2400	<i>3000</i>	<i>3000</i>
	5500	2500	3000	3000	2050	3000	<i>3000</i>
	6000	2000	2800	3000	1800	3000	<i>3000</i>
	6500	1600	2250	3000	1600	2550	<i>3000</i>
	7000	1300	1800	2400	1400	2200	<i>3000</i>
	7500	1050	1400	1850	1250	1950	<i>2700</i>
	8000	800	1100	1450			
	8500	650	850	1150			
	9000	550	700	900			
	9500	400	550	750			
	10000		450	600			
	10500	550	750	1000			
	11000	450	650	850			
	11500	400	550	700			
	12000		450	600			
	12500		400	500			
	13000			450			
13500							
N2	5000	2200	3000	3000	1700	<i>2950</i>	<i>3000</i>
	5500	1800	2600	3000	1500	2500	<i>3000</i>
	6000	1450	2050	2800	1300	2150	<i>3000</i>
	6500	1150	1600	2200	1150	1850	<i>2600</i>
	7000	950	1300	1750	1000	1600	<i>2250</i>
	7500	750	1000	1350	900	1400	<i>1950</i>
	8000	600	800	1050			
	8500	450	600	800			
	9000	350	500	650			
	9500	300	400	500			
	10000		300	400			
	10500	400	550	750			
	11000	350	450	600			
	11500	300	400	500			
	12000		300	450			
	12500			350			
	13000			300			
13500							
N3	5000	1400	2000	2800	1100	<i>1900</i>	<i>2800</i>
	5500	1150	1650	2250	950	1600	<i>2350</i>
	6000	900	1300	1800	800	1400	<i>1950</i>
	6500	750	1050	1400	750	1200	<i>1650</i>
	7000	600	800	1100	650	1000	<i>1450</i>
	7500	450	650	850	550	900	<i>1250</i>
	8000	350	500	650			
	8500	300	400	500			
	9000		300	400			
	9500		250	300			
	10000						
	10500		350	450			
	11000		300	400			
	11500			300			
	12000						
	12500						
	13000						
13500							

Table values continued on next page

Shaded areas require 1 row of Stramit bridging

Shaded areas require 2 rows of Stramit bridging

	Z only 3 lapped span spacing (mm)		
	25015EX	25019EX	25024EX
	3000	3000	<u>3000</u>
	2900	3000	<u>3000</u>
	2600	3000	<u>3000</u>
	2350	3000	<u>3000</u>
	2100	3000	<u>3000</u>
	1900	2900	<u>3000</u>
	1750	2400	<u>3000</u>
	1450	2000	<u>2700</u>
	1250	1700	2200
	1000	1400	1800
	850	1150	1450
	1050	1500	2050
	900	1300	1800
	800	1150	1550
	700	1000	1350
	650	900	1150
	550	750	1000
	500	650	850
	2350	3000	<u>3000</u>
	2100	3000	<u>3000</u>
	1850	3000	<u>3000</u>
	1700	3000	<u>3000</u>
	1500	2550	<u>3000</u>
	1400	2100	<u>2900</u>
	1250	1750	<u>2400</u>
	1050	1450	<u>1950</u>
	900	1200	1600
	700	1000	1300
	600	800	1050
	750	1050	1450
	650	950	1300
	600	800	1100
	500	700	950
	450	650	850
	400	550	700
	350	450	600
	1500	2800	<u>3000</u>
	1350	2450	<u>3000</u>
	1200	2150	<u>3000</u>
	1050	1900	<u>2700</u>
	950	1600	<u>2250</u>
	900	1350	<u>1850</u>
	800	1100	<u>1500</u>
	650	900	<u>1250</u>
	550	750	1000
	450	650	800
	350	500	650
	450	650	950
	400	600	800
	350	500	700
	300	450	600
	300	400	550
		350	450
		300	400

Table 10.7 C/Z 250 Exacta® purlin - Part 2

Continued from previous page

Wind load	Purlin span (mm)	C and Z single span spacing (mm)			C and Z double span spacing (mm)		
		25015EX	25019EX	25024EX	25015EX	25019EX	25024EX
N4	5000	950	1350	1900	700	1250	1900
	5500	750	1100	1500	600	1050	1550
	6000	600	850	1200	550	900	1300
	6500	500	700	950	500	800	1100
	7000	400	550	750	400	650	950
	7500	300	450	550	400	600	850
	8000		350	450			
	8500			350			
	9000						
	9500						
	10000						
	10500			300			
	11000						
	11500						
12000							
12500							
13000							
13500							
N5	5000	650	900	1300	500	850	1300
	5500	500	750	1000	400	700	1050
	6000	400	600	800	350	600	900
	6500	300	450	650	300	500	750
	7000		350	500	300	450	650
	7500		300	350		400	550
	8000			300			
	8500						
	9000						
	9500						
	10000						
	10500						
	11000						
	11500						
12000							
N6	5000	450	650	950	350	600	950
	5500	350	550	750	300	550	750
	6000	300	400	600		450	650
	6500		350	450		400	550
	7000			350		350	450
	7500					300	400
	8000						
	8500						
	9000						
	9500						
	10000						
	10500						
	11000						

Shaded areas require 1 row of Stramit bridging

Shaded areas require 2 rows of Stramit bridging

	Z only 3 lapped span spacing (mm)		
	25015EX	25019EX	25024EX
	1000	1850	<u>3000</u>
	900	1650	<u>2600</u>
	800	1450	2200
	700	1300	1800
	650	1100	1500
	600	900	1250
	500	750	1000
	450	600	800
	350	500	650
	300	400	550
		350	450
	300	450	600
		400	550
		350	450
		300	400
			350
			300
	650	1250	2150
	600	1100	1750
	550	950	1500
	450	850	1200
	450	750	1000
	400	600	850
	350	500	700
	300	400	550
		350	450
			350
			300
		300	400
			350
			300
	500	950	<u>1600</u>
	450	800	<u>1300</u>
	400	700	1100
	350	650	900
	300	550	750
	300	450	600
		350	500
		300	400
			300
			300

Table 10.8 C/Z 250 Exacta® purlin

All spans/spacings calculated for roof loads

Fasteners: Purlins connected to cleats with M12 x 30mm bolts

Values in ***bold italics*** require Grade 8.8 bolts

Underlined values require M16 Grade 8.8 bolts

Wind load	Purlin span (mm)	C and Z single span spacing (mm)			C and Z double span spacing (mm)		
		25015EX	25019EX	25024EX	25015EX	25019EX	25024EX
C1	5000	1100	1600	2250	850	<i>1500</i>	<i>2250</i>
	5500	900	1300	1800	750	1300	<i>1850</i>
	6000	700	1050	1400	650	1100	<i>1550</i>
	6500	600	800	1150	600	950	<i>1300</i>
	7000	450	650	850	500	800	<i>1150</i>
	7500	350	500	650	450	700	<i>1000</i>
	8000	300	400	500			
	8500		300	400			
	9000			300			
	9500						
	10000						
	10500			350			
	11000			300			
	11500						
	12000						
12500							
13000							
13500							
14000							
C2	5000	750	1050	1500	550	<i>1000</i>	<i>1500</i>
	5500	600	900	1200	500	850	<i>1250</i>
	6000	500	700	950	450	750	<i>1050</i>
	6500	400	550	750	400	600	<i>900</i>
	7000	300	450	600	350	550	<i>750</i>
	7500		350	450	300	450	<i>650</i>
	8000			350			
	8500						
	9000						
	9500						
	10000						
	10500						
	11000						
	11500						
	12000						
C3	5000	500	700	1000	400	<i>650</i>	<i>1000</i>
	5500	400	600	800	350	550	<i>850</i>
	6000	300	450	650	300	500	<i>700</i>
	6500		350	500		400	<i>600</i>
	7000		300	400		350	<i>500</i>
	7500			300		300	<i>450</i>
	8000						
	8500						
	9000						
	9500						
	10000						
	10500						
	11000						
	11500						
	12000						
C4	5000	350	500	750	300	<i>500</i>	<i>750</i>
	5500	300	450	600		400	<i>600</i>
	6000		350	450		350	<i>500</i>
	6500			350		300	<i>450</i>
	7000			300			<i>350</i>
	7500						<i>300</i>
	8000						
	8500						
	9000						

Shaded areas require 1 row of Stramit bridging

Shaded areas require 2 rows of Stramit bridging

	Z only 3 lapped span spacing (mm)		
	25015EX	25019EX	25024EX
	1200	2200	<u>3000</u>
	1050	1950	<u>3000</u>
	950	1700	2600
	850	1550	2150
	750	1300	1750
	700	1050	1450
	600	900	1200
	500	750	1000
	450	600	800
	350	500	650
	300	400	500
	350	550	750
	350	450	650
	300	400	550
		350	500
		300	400
			350
			300
	800	1500	<u>2500</u>
	700	1300	<u>2100</u>
	650	1150	1750
	550	1000	1450
	500	850	1200
	450	700	1000
	400	600	800
	350	500	650
	300	400	550
		350	450
			350
		350	500
		300	450
			350
			300
	550	1000	<u>1700</u>
	450	900	<u>1400</u>
	400	750	1200
	350	700	950
	350	600	800
	300	450	650
		400	550
		300	450
			350
			300
			350
			300
	400	750	<u>1250</u>
	350	650	<u>1050</u>
	300	550	850
		500	700
		400	600
		350	500
		300	400
			300

Table 10.9 C/Z 300 Exacta® purlin - Part 1

All spans/spacings calculated for roof loads

Fasteners: Purlins connected to cleats with M16 x 33mm bolts

Values in **bold italics** require Grade 8.8 bolts

Wind load	Purlin span (mm)	C and Z single span spacing (mm)			C and Z double span spacing (mm)		
		30019EX	30024EX	30030EX	30019EX	30024EX	30030EX
N1	6000	3000	3000	3000	3000	3000	<i>3000</i>
	6500	3000	3000	3000	2900	3000	<i>3000</i>
	7000	3000	3000	3000	2600	3000	<i>3000</i>
	7500	2500	3000	3000	2300	3000	<i>3000</i>
	8000	2100	2900	3000			
	8500	1800	2400	3000			
	9000	1550	2050	2850			
	9500	1250	1700	2350			
	10000	1050	1400	1900			
	10500	850	1200	1600			
	11000	750	1000	1300			
	11500	600	800	1100			
	12000	550	700	950			
	12500	800	1100	1450			
	13000	750	1000	1300			
13500	650	850	1150				
14000	550	800	1050				
14500	500	700	900				
15000	450	600	800				
N2	6000	2950	3000	3000	2350	3000	<i>3000</i>
	6500	2500	3000	3000	2100	3000	<i>3000</i>
	7000	2150	3000	3000	1850	3000	<i>3000</i>
	7500	1800	2500	3000	1650	2650	<i>3000</i>
	8000	1500	2100	3000			
	8500	1300	1750	2450			
	9000	1100	1450	2050			
	9500	900	1250	1650			
	10000	750	1000	1350			
	10500	600	850	1150			
	11000	500	700	950			
	11500	450	600	800			
	12000	350	500	650			
	12500	600	800	1150			
	13000	500	700	1000			
13500	450	600	850				
14000	400	550	750				
14500	350	500	650				
15000	300	400	600				
N3	6000	1900	2700	3000	1500	2550	<i>3000</i>
	6500	1600	2300	3000	1350	2250	<i>3000</i>
	7000	1350	1950	2750	1200	1950	<i>2800</i>
	7500	1150	1600	2300	1050	1700	<i>2400</i>
	8000	950	1350	1900			
	8500	800	1100	1600			
	9000	700	950	1300			
	9500	550	800	1050			
	10000	450	650	850			
	10500	400	550	700			
	11000	350	450	600			
	11500	300	350	500			
	12000	250	300	400			
	12500	350	500	700			
	13000	300	450	650			
13500	300	400	550				
14000		350	500				
14500		300	400				
15000			350				

Table values continued on next page



- Shaded areas require 1 row of Stramit bridging
- Shaded areas require 2 rows of Stramit bridging

Z only 5 lapped span spacing (mm)			
30019EX	30024EX	30030EX	
3000	3000	3000	
3000	3000	3000	
3000	3000	3000	
3000	3000	3000	
3000	3000	3000	
2750	3000	3000	
2550	3000	3000	
2350	3000	3000	
2150	3000	3000	
1950	2600	3000	
1700	2300	3000	
1500	2000	2750	
1300	1750	2350	
3000	3000	3000	
2850	3000	3000	
2600	3000	3000	
2350	3000	3000	
2150	3000	3000	
2000	3000	3000	
1800	2950	3000	
1650	2550	3000	
1550	2200	3000	
1400	1900	2700	
1200	1650	2300	
1050	1450	2000	
900	1250	1700	
1050	1550	2150	
1000	1350	1950	
900	1250	1750	
2000	3000	3000	
1800	3000	3000	
1650	2950	3000	
1500	2650	3000	
1350	2400	3000	
1250	2150	3000	
1150	1850	2650	
1050	1600	2300	
1000	1400	2000	
900	1200	1700	
750	1050	1450	
700	900	1250	
600	800	1100	
700	950	1350	
600	850	1250	
550	800	1100	

Table 10.9 C/Z 300 Exacta® purlin - Part 2

Continued from previous page

Wind load	Purlin span (mm)	C and Z single span spacing (mm)			C and Z double span spacing (mm)		
		30019EX	30024EX	30030EX	30019EX	30024EX	30030EX
N4	6000	1250	1800	2550	1000	1700	2550
	6500	1050	1500	2150	900	1500	2150
	7000	900	1300	1800	800	1300	1850
	7500	750	1050	1500	700	1150	1600
	8000	650	900	1250			
	8500	550	750	1050			
	9000	450	600	850			
	9500	400	500	700			
	10000	300	450	600			
	10500		350	450			
	11000		300	400			
	11500			350			
	12000						
	12500		350	450			
	13000		300	400			
13500			350				
14000			300				
N5	6000	850	1200	1700	650	1150	1700
	6500	700	1050	1450	600	1000	1450
	7000	600	850	1250	550	900	1250
	7500	500	700	1050	450	750	1100
	8000	450	600	850			
	8500	350	500	700			
	9000	300	400	600			
	9500		350	450			
	10000		300	400			
	10500			300			
	11000						
	11500						
	12000						
	12500			300			
	13000						
13500							
N6	6000	600	900	1250	500	850	1250
	6500	550	750	1050	450	750	1050
	7000	450	650	900	400	650	900
	7500	350	550	750	350	550	800
	8000	300	450	650			
	8500		350	500			
	9000		300	400			
	9500			350			
	10000			300			
	10500						
	11000						
	11500						
	12000						
	12500						
	13000						
13500							

-  Shaded areas require 1 row of Stramit bridging
-  Shaded areas require 2 rows of Stramit bridging

Z only 5 lapped span spacing (mm)			
	30019EX	30024EX	30030EX
	1350	2450	3000
	1200	2200	3000
	1100	1950	3000
	1000	1750	2600
	900	1600	2300
	850	1450	2050
	750	1250	1750
	700	1050	1550
	650	950	1350
	600	800	1150
	500	700	1000
	450	600	850
	400	500	700
	450	650	900
	400	600	800
	350	500	750
	900	1650	2750
	800	1500	2400
	750	1300	2050
	650	1200	1750
	600	1050	1550
	550	950	1350
	500	850	1200
	450	700	1050
	450	600	900
	400	550	750
	350	450	650
	300	400	550
		350	500
	300	450	600
		400	550
		350	500
	650	1200	2050
	600	1100	1750
	550	950	1500
	500	850	1300
	450	800	1150
	400	700	1000
	350	600	850
	350	550	750
	300	450	650
	300	400	550
		350	500
		300	400
			350
		300	450
		300	400
			350

Table 10.10 C/Z 300 Exacta® purlin

All spans/spacings calculated for roof loads

Fasteners: Purlins connected to cleats with M16 x 33mm bolts

Values in **bold italics** require Grade 8.8 bolts

Wind load	Purlin span (mm)	C and Z single span spacing (mm)			C and Z double span spacing (mm)		
		30019EX	30024EX	30030EX	30019EX	30024EX	30030EX
C1	6000	1500	2150	3000	1200	2050	<i>3000</i>
	6500	1300	1800	2550	1050	1800	<i>2550</i>
	7000	1100	1550	2150	950	1550	<i>2200</i>
	7500	900	1300	1800	850	1350	<i>1950</i>
	8000	750	1050	1500			
	8500	650	900	1250			
	9000	550	750	1050			
	9500	450	600	850			
	10000	350	500	700			
	10500	300	400	550			
	11000		350	450			
	11500		300	400			
	12000			350			
	12500	300	400	550			
	13000		350	500			
13500		300	450				
14000			350				
14500			300				
15000			300				
C2	6000	1000	1450	2050	800	1350	<i>2050</i>
	6500	850	1200	1700	700	1200	<i>1700</i>
	7000	700	1050	1450	650	1050	<i>1500</i>
	7500	600	850	1200	550	900	<i>1300</i>
	8000	500	700	1000			
	8500	450	600	850			
	9000	350	500	700			
	9500	300	400	550			
	10000		350	450			
	10500			350			
	11000			300			
	11500						
	12000						
	12500			350			
	13000			350			
13500			300				
C3	6000	650	950	1350	550	900	<i>1350</i>
	6500	550	800	1150	450	800	<i>1150</i>
	7000	500	700	1000	400	700	<i>1000</i>
	7500	400	550	800	350	600	<i>850</i>
	8000	350	450	700			
	8500	300	400	550			
	9000		300	450			
	9500			350			
	10000			300			
	10500						
	11000						
	11500						
	12000						
	12500						
	13000						
13500							
C4	6000	500	700	1000	400	650	<i>1000</i>
	6500	400	600	850	350	600	<i>850</i>
	7000	350	500	700	300	500	<i>750</i>
	7500	300	400	600		450	<i>650</i>
	8000		350	500			
	8500		300	400			
	9000			350			
	9500						
	10000						
	10500						
	11000						
	11500						
12000							

Shaded areas require 1 row of Stramit bridging

Shaded areas require 2 rows of Stramit bridging

Z only 5 lapped span spacing (mm)			
	30019EX	30024EX	30030EX
	1600	2900	3000
	1450	2600	3000
	1300	2350	3000
	1200	2100	3000
	1100	1900	2750
	1000	1700	2400
	900	1500	2100
	850	1300	1800
	800	1100	1600
	700	950	1350
	600	850	1150
	550	700	1000
	450	650	850
	550	750	1100
	500	700	1000
	450	600	900
	1050	1950	3000
	950	1750	2800
	900	1550	2400
	800	1400	2100
	750	1250	1850
	650	1150	1600
	600	1000	1400
	550	850	1200
	500	750	1050
	450	650	900
	400	550	800
	350	500	650
	300	400	550
	350	500	700
	300	450	650
	300	400	600
	700	1300	2200
	650	1200	1900
	600	1050	1650
	550	950	1400
	500	850	1250
	450	750	1100
	400	650	950
	350	550	800
	350	500	700
	300	400	600
		350	500
		300	450
			400
		350	500
		300	450
			400
	550	950	1600
	450	850	1400
	450	750	1200
	400	700	1050
	350	650	900
	300	550	800
	300	500	700
		400	600
		350	500
		300	450
			400
			300

Table 10.11 C/Z 350 Exacta® purlin - Part 1

All spans/spacings calculated for roof loads

Fasteners: Purlins connected to cleats with M16 x 33mm bolts

Values in **bold italics** require Grade 8.8 bolts

Wind load	Purlin span (mm)	C and Z single span spacing (mm)			C and Z double span spacing (mm)		
		35019EX	35024EX	35030EX	35019EX	35024EX	35030EX
N1	7000	3000	3000	3000	2600	3000	<i>3000</i>
	7500	3000	3000	3000	2400	3000	<i>3000</i>
	8000	2950	3000	3000			
	8500	2600	3000	3000			
	9000	2250	3000	3000			
	9500	2000	2850	3000			
	10000	1750	2500	3000			
	10500	1500	2200	2900			
	11000	1350	1950	2500			
	11500	1150	1650	2150			
	12000	1000	1450	1900			
	12500	900	1250	1650			
	13000	800	1050	1450			
	13500	700	950	1250			
	14000	600	800	1100			
	14500	800	1150	1500			
	15000	750	1050	1350			
N2	7000	2800	3000	3000	1900	3000	<i>3000</i>
	7500	2450	3000	3000	1700	3000	<i>3000</i>
	8000	2150	3000	3000			
	8500	1850	2700	3000			
	9000	1650	2350	3000			
	9500	1400	2050	2800			
	10000	1250	1800	2400			
	10500	1100	1600	2100			
	11000	950	1400	1800			
	11500	850	1200	1550			
	12000	750	1050	1350			
	12500	650	900	1200			
	13000	550	750	1050			
	13500	500	650	900			
	14000	450	600	800			
	14500	600	850	1150			
	15000	550	800	1050			
N3	7000	1800	2550	3000	1200	2100	<i>3000</i>
	7500	1550	2200	3000	1100	1900	<i>3000</i>
	8000	1350	1950	2700			
	8500	1200	1700	2400			
	9000	1050	1500	2050			
	9500	900	1300	1800			
	10000	800	1150	1550			
	10500	700	1000	1350			
	11000	600	900	1150			
	11500	550	750	1000			
	12000	450	650	850			
	12500	400	550	750			
	13000	350	500	650			
	13500	300	400	550			
	14000		350	500			
	14500	350	550	750			
	15000	350	500	650			

Table values continued on next page

- Shaded areas require 1 row of Stramit bridging
- Shaded areas require 2 rows of Stramit bridging

	Z only 5 lapped span spacing (mm)		
	35019EX	35024EX	35030EX
	3000	3000	3000
	3000	3000	3000
	2850	3000	3000
	2650	3000	3000
	2450	3000	3000
	2300	3000	3000
	2150	3000	3000
	2000	3000	3000
	1900	3000	3000
	1800	3000	3000
	1700	2900	3000
	1600	2600	3000
	1500	2350	3000
	1400	2100	2800
	2450	3000	3000
	2250	3000	3000
	2050	3000	3000
	1900	3000	3000
	1800	3000	3000
	1650	3000	3000
	1550	2750	3000
	1450	2550	3000
	1350	2400	3000
	1300	2250	3000
	1200	2050	2800
	1150	1850	2500
	1050	1700	2250
	1000	1500	2000
	1550	2900	3000
	1400	2650	3000
	1300	2400	3000
	1200	2250	3000
	1150	2050	3000
	1050	1900	3000
	1000	1750	2800
	900	1650	2550
	850	1500	2250
	800	1400	2000
	750	1300	1800
	700	1200	1600
	700	1050	1450
	650	950	1250

Table 10.11 C/Z 350 Exacta® purlin - Part 2

Continued from previous page

Wind load	Purlin span (mm)	C and Z single span spacing (mm)			C and Z double span spacing (mm)		
		35019EX	35024EX	35030EX	35019EX	35024EX	35030EX
N4	7000	1200	1700	2350	800	1400	2350
	7500	1050	1450	2050	700	1250	2050
	8000	900	1300	1800			
	8500	800	1150	1600			
	9000	700	1000	1400			
	9500	600	850	1200			
	10000	500	750	1000			
	10500	450	650	900			
	11000	400	600	750			
	11500	350	500	650			
	12000	300	450	550			
	12500		350	500			
	13000		300	450			
	13500			350			
	14000			300			
14500		350	500				
15000		300	450				
N5	7000	800	1150	1600	550	950	1550
	7500	700	1000	1400	500	850	1400
	8000	600	850	1200			
	8500	550	750	1100			
	9000	450	650	950			
	9500	400	600	800			
	10000	350	500	700			
	10500	300	450	600			
	11000		400	500			
	11500		350	450			
	12000		300	400			
	12500			350			
	13000			300			
	13500						
	N6	7000	600	850	1200	400	700
7500		500	750	1000	350	650	1000
8000		450	650	900			
8500		400	550	800			
9000		350	500	700			
9500		300	400	600			
10000			350	500			
10500			300	450			
11000			300	350			
11500				300			
12000							
12500							
13000							
13500							

Shaded areas require 1 row of Stramit bridging

Shaded areas require 2 rows of Stramit bridging

Z only 5 lapped span spacing (mm)			
	35019EX	35024EX	35030EX
	1050	1950	3000
	950	1750	3000
	900	1600	2800
	800	1500	2550
	750	1350	2300
	700	1250	2050
	650	1150	1850
	600	1100	1700
	550	1000	1500
	550	950	1350
	500	900	1200
	500	800	1050
	450	700	950
	400	650	850
	700	1300	2300
	650	1200	2050
	600	1100	1900
	550	1000	1700
	500	900	1550
	450	850	1400
	450	800	1250
	400	750	1150
	400	700	1000
	350	650	900
	350	600	800
	300	550	700
	300	500	650
	300	450	550
	500	950	1700
	450	900	1550
	450	800	1400
	400	750	1250
	350	700	1150
	350	600	1050
	300	600	900
	300	550	850
	300	500	750
		450	650
		450	600
		400	500
		350	450
		300	400

Table 10.12 C/Z 350 Exacta® purlin

All spans/spacings calculated for roof loads

Fasteners: Purlins connected to cleats with M16 x 33mm bolts

Values in **bold italics** require Grade 8.8 bolts

Wind load	Purlin span (mm)	C and Z single span spacing (mm)			C and Z double span spacing (mm)		
		35019EX	35024EX	35030EX	35019EX	35024EX	35030EX
C1	7000	1400	2000	2800	950	1700	<i>2750</i>
	7500	1250	1750	2450	850	1500	<i>2450</i>
	8000	1100	1550	2150			
	8500	950	1350	1900			
	9000	800	1200	1650			
	9500	700	1050	1400			
	10000	600	900	1200			
	10500	550	800	1050			
	11000	500	700	900			
	11500	400	600	800			
	12000	350	500	700			
	12500	300	450	600			
	13000		400	500			
	13500		350	450			
	14000		300	400			
	14500	300	400	600			
15000		400	500				
C2	7000	950	1350	1900	650	1100	<i>1850</i>
	7500	800	1150	1650	550	1000	<i>1650</i>
	8000	700	1050	1450			
	8500	650	900	1250			
	9000	550	800	1100			
	9500	450	700	950			
	10000	400	600	800			
	10500	350	550	700			
	11000	300	450	600			
	11500		400	500			
	12000		350	450			
	12500		300	400			
	13000			350			
	13500			300			
C3	7000	650	900	1300	400	750	<i>1250</i>
	7500	550	800	1100	400	700	<i>1100</i>
	8000	500	700	950			
	8500	400	600	850			
	9000	350	550	750			
	9500	300	450	650			
	10000		400	550			
	10500		350	450			
	11000		300	400			
	11500			350			
	12000			300			
	12500						
	13000						
	13500						
C4	7000	450	650	950	300	550	<i>900</i>
	7500	400	600	800	300	500	<i>800</i>
	8000	350	500	700			
	8500	300	450	650			
	9000		400	550			
	9500		350	450			
	10000		300	400			
	10500			350			
	11000			300			
	11500						
	12000						
	12500						
	13000						
	13500						

Shaded areas require 1 row of Stramit bridging

Shaded areas require 2 rows of Stramit bridging

	Z only 5 lapped span spacing (mm)		
	35019EX	35024EX	35030EX
	1250	2300	3000
	1150	2100	3000
	1050	1950	3000
	950	1750	3000
	900	1650	2750
	850	1500	2450
	800	1400	2200
	750	1300	2000
	700	1200	1800
	650	1150	1600
	600	1050	1450
	550	950	1250
	550	850	1150
	500	750	1000
	800	1550	2700
	750	1400	2450
	700	1300	2250
	650	1200	2050
	600	1100	1850
	550	1000	1650
	500	950	1500
	500	850	1350
	450	800	1200
	450	750	1050
	400	700	950
	400	650	850
	350	550	750
	350	500	650
	550	1050	1850
	500	950	1650
	450	850	1500
	450	800	1350
	400	750	1250
	350	700	1100
	350	650	1000
	300	600	900
	300	550	800
	300	500	700
		450	650
		400	550
		400	500
		350	450
	400	750	1350
	350	700	1200
	350	650	1100
	300	600	1000
	300	550	900
		500	800
		450	750
		400	650
		400	600
		350	550
		350	450
		300	400
			350
			350

C&Z purlins and girts

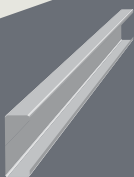

Purlin C



Purlin Z

Stramit's traditional sized range of purlins and girts in C&Z profiles will match existing or new project specifications.

- C sections ideally suited to single or double span construction
- Z sections can be used for single spans and in unlapped and lapped continuous span construction
- High tensile steel for high strength and low weight
- Available in sizes 100mm, 150mm, 200mm, 250mm, 300mm and 350mm
- Snap-in purlin bridge system offers quick installation



■ AVAILABLE
■ NOT AVAILABLE



Accessories

Stramit has a range of purpose made accessory brackets and connectors to complete the purlin system. These brackets allow easy connection to window frames, or any other structure.

Performance

The performance of Stramit® C&Z purlins is found in the Stramit® *Purlin and Girt Technical Manual*.

Notes:



11. Top Hats

Second to none

STRAMIT® TOP HATS ARE IDEAL FOR USE AS SECONDARY MEMBERS SUPPORTING ROOF AND WALL CLADDING IN SMALL TO MEDIUM SIZED SHEDS AND SIMILAR STRUCTURES

Manufactured from high tensile steel, they provide excellent durability in most applications, but are not recommended for use in enclosed areas within 450mm of moist soil, or in marine or heavy industrial environments.

Lap lengths and design

Lapped Stramit® top hat configurations require a minimum 10% lap length (i.e. 5% at each end). Section properties within the lap have been assumed to be twice that of a single section rather than the properties of a double thickness section.

End fastenings of top hats are recommended to be at least 25mm from the section end regardless of whether this occurs at the structure end or at an internal support. Remember to allow for this additional material over and above the span length/s when specifying, ordering or cutting sections.

Stramit® top hats TH96 and TH64 have one end partially crimped to facilitate lapping. Top hat overlaps (or non-structural laps) are recommended to be 100mm in length. In these cases, structural continuity must not be assumed, and all spans are assumed to be single spans.

Double spans are simply supported, and a continuous length across both spans and attached at each end and at the middle support (unlapped).

Double lapped spans are simply supported and consist of two lengths of top hat, lapped over the middle support, and attached at all three supports. Additional fasteners are also required at either end of the lapped section.

Multiple or triple lapped spans are individual lapped spans over four or more supports.

Loadings

All loadings used in deriving the design data are assumed to either act uniformly along the top central flange of the sections or, for connections to support members, evenly between each of the lower flanges (feet).

Foot traffic loadings are based on AS 1170.1 R2 - Other roofs.

Framing

Stramit can also supply cold formed steel sections that can be used for stud, plate and nogging frames. These conventional sections are easily assembled using conventional techniques.

How to use the top hat tables

1. Reuse the wind load category used previously in the cladding design.
2. From the top hat performance table (tables 11.1 to 11.3 for non-cyclonic, and tables 11.10 to 11.12 for cyclonic areas) for the required top hat span, determine:
 - The maximum top hat spacing to suit the span type
 - The top hat size and thickness
3. From the top hat connection table (tables 11.4 to 11.9 for non-cyclonic and table 11.13 for cyclonic areas), to suit the required top hat span, determine:
 - The maximum top hat spacing to suit the span type
 - The support thickness and the size
 - The number of fasteners used in the connection

If timber supports are used then refer to the results under the 1.5mm support thickness. Please note, both the top hat and the connection performance must be considered and the lowest result taken as the top hat capacity required.

4. Confirm that the top hat spacing is equal to or greater than the cladding span previously selected.

Designers can revisit and modify the cladding specification or the top hat detail to achieve the final solution.

5. Ensure the correct fastener detail from the tables is used in the final solution.

Please refer to chapter 17 for a worked example on how to use the top hat tables.

Table 11.0 Top Hat mass

Top Hat size	Mass (kg/m)
64075	1.25
64100	1.65
64120	1.98
96075	1.64
96100	2.18
96120	2.60
12070	2.05
12090	2.63

Summary Checklist

- ✓ Check different top hat sizes to obtain the best performance fit
- ✓ Use different fastener sizes or frequencies to complete the top hat design
- ✓ Always use the correct fastener specified at the top of the connection table
- ✓ Improve the overall performance by using multiple lapped span combinations wherever possible
- ✓ Revise the cladding design if needed
- ✓ For more information go to [Stramit.com.au/products/](https://www.stramit.com.au/products/)

Stramit® Top Hats

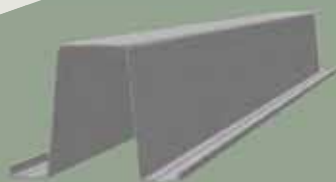
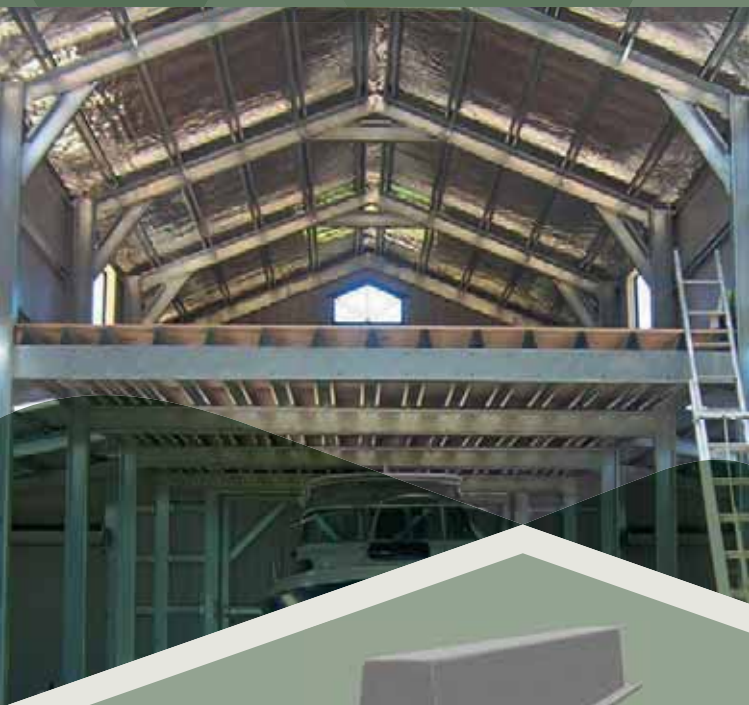

Stramit® top hats can be used as a purlin or girt for sheds and light industrial and commercial buildings.

- Range of thicknesses offers design efficiency
- No bridging
- Simple screw fasteners and screw locating ridges make it quick and easy to install
- Easy to handle and store



AVAILABLE



NOT AVAILABLE



Fastening location

Top hats are connected to the supporting structure with two or four self-drilling fasteners placed through the bottom flanges in a symmetrical arrangement. As the performance of the top hat is often dependent upon the choice of fastener and support thickness, it is important to ensure conformance to the fixing requirements.

Performance

The following tables are based on the roof loads from AS 4055. The same tables can be used conservatively for walls, or experienced users can refer to actual wall loads and compare to these tables as required.

Tables for both the section and the connection to the structure must be used to determine the design solution.

Table 11.1 64 Top hat

All spans/spacings calculated for roof edge loads

Spans/spacings need to be checked for support fastener performance tables 11.5 to 11.8

Wind load	Top hat span (mm)	Single span spacing (mm)			Double span spacing (mm)		
		64075	64100	64120	64075	64100	64120
N1	1500	3000	3000	3000	3000	3000	3000
	2000	1700	2450	3000	1900	2800	3000
	2500	1050	1550	2000	1250	1800	2300
	3000	600	850	1050	850	1250	1600
	3500	350	500	600	600	900	1150
	4000		300	350	450	700	850
	4500					450	550
	5000					300	400
5500						300	
N2	1500	2650	3000	3000	2400	3000	3000
	2000	1200	1800	2350	1400	2050	2550
	2500	750	1150	1500	900	1300	1650
	3000	500	800	1050	600	900	1150
	3500	350	500	600	450	650	850
	4000		300	350	350	500	650
	4500					400	500
	5000					300	400
5500						300	
N3	1500	1700	2300	2750	1550	2250	2400
	2000	750	1150	1500	900	1300	1650
	2500	500	700	950	550	800	1050
	3000	350	500	650	400	550	700
	3500		300	400	300	400	500
	4000					300	400
	4500						300
	5000						
5500							
N4	1500	1150	1500	1850	1050	1500	1600
	2000	500	750	1000	600	850	1100
	2500	300	450	650	350	550	700
	3000		300	450		350	450
	3500						350
	4000						
	4500						
	5000						
5500							
N5	1500	750	1050	1250	700	1000	1100
	2000	350	500	650	400	600	750
	2500		300	400		350	450
	3000			300			300
	3500						
	4000						
	4500						
	5000						
5500							
N6	1500	550	750	900	500	750	800
	2000		350	500	300	400	550
	2500			300			350
	3000						
	3500						
	4000						
	4500						
	5000						
5500							

Spacings in red exceed the 1.4kN serviceability foot traffic load

	Double lapped span spacing (mm)			Triple lapped span spacing (mm)		
	64075	64100	64120	64075	64100	64120
	3000	3000	3000	3000	3000	3000
	2300	3000	3000	2700	3000	3000
	1500	2200	2750	1750	2550	3000
	1050	1500	1900	1200	1750	2100
	750	1100	1400	700	1000	1200
	500	750	950	450	600	750
	350	500	600		400	500
		350	400			350
			300			
	2900	3000	3000	3000	3000	3000
	1650	2450	2750	1950	2850	3000
	1050	1550	2000	1250	1850	2400
	750	1100	1350	850	1250	1650
	550	800	1000	600	900	1200
	400	600	750	450	600	750
	300	450	600		400	500
		350	400			350
		300				
	1850	2350	2350	2250	2700	2700
	1050	1550	1750	1250	1850	2050
	700	1000	1250	800	1150	1550
	450	700	850	550	800	1050
	350	500	650	400	600	750
		400	500	300	400	500
		300	350			300
	1250	1600	1600	1500	1800	1800
	700	1050	1200	850	1200	1350
	450	650	850	500	750	1000
	300	450	600	350	550	700
		350	400		400	500
			300			300
	850	1050	1050	1000	1200	1200
	450	700	800	550	800	900
	300	450	550	350	500	700
		300	400		350	450
			300			350
	600	800	800	750	900	900
	350	500	600	400	600	650
		300	400		400	500
			300			350

Table 11.2.96 Top hat

All spans/spacings calculated for roof edge loads

Spans/spacings need to be checked for support fastener performance tables 11.5 to 11.8

Wind load	Top hat span (mm)	Single span spacing (mm)			Double span spacing (mm)		
		96075	96100	96120	96075	96100	96120
N1	1500	3000	3000	3000	3000	3000	3000
	2000	3000	3000	3000	2600	3000	3000
	2500	1500	2200	2800	1750	2950	3000
	3000	1000	1500	1950	1250	2250	2600
	3500	750	1000	1250	900	1650	2100
	4000	450	600	750	700	1300	1600
	4500		400	500	550	900	1150
	5000			350	450	650	800
	5500					450	550
	6000					300	400
N2	1500	3000	3000	3000	2650	3000	3000
	2000	2300	3000	3000	1850	2650	2800
	2500	1050	1600	2000	1250	2100	2250
	3000	700	1100	1400	900	1600	1850
	3500	500	800	1000	650	1200	1500
	4000	400	600	750	500	900	1150
	4500		400	500	400	700	900
	5000			350	300	600	750
	5500					450	550
	6000					300	400
N3	1500	3000	3000	3000	1700	2250	2400
	2000	1450	2000	2500	1200	1700	1800
	2500	650	1000	1300	800	1350	1450
	3000	450	700	900	550	1050	1200
	3500	350	500	650	400	750	950
	4000		400	500	300	600	750
	4500			300		450	550
	5000					350	450
	5500					300	350
	6000						
N4	1500	2200	2950	3000	1150	1500	1600
	2000	1000	1350	1650	800	1150	1200
	2500	450	650	850	500	900	950
	3000	300	450	600	350	700	800
	3500		350	400		500	650
	4000			300		400	500
	4500					300	350
	5000						300
	5500						
	6000						
N5	1500	1500	2000	2400	750	1000	1100
	2000	650	900	1100	550	750	800
	2500	300	450	550	350	600	650
	3000		300	400		450	550
	3500			300		350	400
	4000						300
	4500						
	5000						
	5500						
	6000						
N6	1500	1100	1450	1750	550	750	800
	2000	500	650	800	400	550	600
	2500		300	400		450	450
	3000			300		350	400
	3500						300
	4500						

Spacings in red exceed the 1.4kN serviceability foot traffic load

	Double lapped span spacing (mm)			Triple lapped span spacing (mm)		
	96075	96100	96120	96075	96100	96120
	3000	3000	3000	3000	3000	3000
	3000	3000	3000	3000	3000	3000
	2050	3000	3000	2350	3000	3000
	1450	2550	2550	1650	2450	2950
	1100	2000	2200	1200	1800	2300
	850	1550	1900	900	1300	1600
	650	1050	1250	600	800	1050
	500	700	850	400	550	700
	350	500	600		400	500
		350	450			350
	3000	3000	3000	3000	3000	3000
	2150	2750	2750	2700	3000	3000
	1450	2200	2200	1700	2550	2550
	1050	1850	1850	1200	1750	2100
	800	1450	1550	850	1300	1650
	600	1100	1350	650	1000	1250
	500	900	1100	500	750	1000
	400	700	850	400	550	700
	300	500	600		400	500
		350	450			350
	2200	2350	2350	2650	2700	2700
	1400	1750	1750	1700	2050	2050
	950	1400	1400	1100	1600	1600
	650	1150	1150	750	1100	1350
	500	900	1000	550	800	1050
	400	700	850	400	600	800
	300	550	700	300	500	600
		450	550		350	450
		300	400			300
			300			
	1500	1600	1600	1750	1800	1800
	900	1200	1200	1150	1350	1350
	600	950	950	700	1100	1100
	450	800	800	500	750	900
	300	600	650	350	550	700
		450	600		400	550
		350	450		300	400
		300	350			300
	1000	1050	1050	1200	1200	1200
	600	800	800	750	900	900
	400	650	650	500	700	700
	300	500	500	350	500	600
		400	450		350	450
		300	400			350
			300			
			300			
	750	800	800	850	900	900
	450	600	600	550	650	650
	300	450	450	350	550	550
		400	400		350	450
		300	300			350

Table 11.3 120 Top hat

All spans/spacings calculated for roof edge loads and use 2 fasteners per connection. Spans/spacings need to be checked for support fastener performance table 11.9

Wind Load	Top hat span (mm)	Single span spacing (mm)		Double span spacing (mm)	
		12070	12090	12070	12090
N1	2500	2250	2750	1150	1550
	3000	1500	1800	950	1300
	3500	1050	1250	800	1100
	4000	800	900	700	950
	4500	600	700		
	5000	450	550		
	5500	350	450		
6000	300	350			
N2	2500	1650	2000	800	1150
	3000	1050	1300	700	900
	3500	750	900	600	800
	4000	550	650	500	650
	4500	400	500		
	5000	350	400		
	5500		300		
6000					
N3	2500	1050	1250	500	700
	3000	650	800	450	600
	3500	450	550	350	500
	4000	350	400	300	400
	4500		300		
	5000				
	5500				
6000					
N4	2500	700	850	350	450
	3000	450	550	300	400
	3500	300	350		300
	4000				300
	4500				
	5000				
	5500				
6000					
N5	2500	450	550		300
	3000	300	350		
	3500				
	4000				
	4500				
	5000				
	5500				
6000					
N6	2500	350	400		
	3000				
	3500				
	4000				
	4500				
	5000				
	5500				
6000					

Spacings in red exceed the 1.4kN serviceability foot traffic load

	Double lapped span spacing (mm)		Triple lapped span spacing (mm)	
	12070	12090	12070	12090
	2750	2950	3000	3000
	2050	2350	2400	2700
	1500	1850	1850	2000
	1150	1400	1450	1500
	900	1050	1150	1200
	750	800	950	950
	600	700	750	800
	500	650	600	650
	2000	2150	2300	2450
	1450	1700	1700	1950
	1100	1350	1300	1450
	850	1000	1000	1100
	650	750	800	850
	500	550	650	700
	450	500	550	550
	350	450	450	450
	1250	1350	1450	1550
	950	1100	1100	1250
	700	850	850	900
	550	600	650	700
	400	450	500	550
	350	350	400	450
		300	350	350
		300		300
	850	900	950	1050
	600	700	750	800
	450	550	550	600
	350	400	450	450
		300	350	350
				300
	550	600	650	700
	400	500	500	550
	300	350	350	400
			300	300
	400	450	500	500
	300	350	350	400
				300

Table 11.4 120 Top hat using 4 fasteners

All spans/spacings calculated for roof edge loads and use 4 fasteners per connection. Spans/spacings need to be checked for support fastener performance table 11.10

Wind Load	Top hat span (mm)	Single span spacing (mm)	Double span spacing (mm)	
			12070	12090
N1	2500		2350	3000
	3000		1750	2350
	3500		1150	1800
	4000		800	1400
	4500			
	5000			
	5500			
N2	2500		1650	2250
	3000		1250	1700
	3500		850	1300
	4000		550	1000
	4500			
	5000			
	5500			
N3	2500		1050	1400
	3000		800	1050
	3500		550	800
	4000		350	650
	4500			
	5000			
	5500			
N4	2500		700	950
	3000		550	700
	3500		350	550
	4000			400
	4500			
	5000			
	5500			
N5	2500		450	650
	3000		350	450
	3500			350
	4000			
	4500			
	5000			
	5500			
N6	2500		350	450
	3000			350
	3500			
	4000			
	4500			
	5000			
	5500			
6000				

Spacings in red exceed the 1.4kN serviceability foot traffic load

	Double lapped span spacing (mm)		Triple lapped span spacing (mm)	
	12070	12090	12070	12090
	2750	3000	3000	3000
	2050	2850	2400	3000
	1500	2100	1800	2150
	1150	1600	1450	1600
	900	1250	1150	1250
	750	1000	950	1000
	600	800	750	850
	500	650	600	700
	2000	2900	2300	3000
	1450	2050	1700	2150
	1100	1500	1300	1550
	850	1150	1000	1150
	650	900	800	900
	500	700	650	750
	450	600	550	600
	350	450	450	500
	1250	1850	1450	2000
	950	1300	1100	1350
	700	950	850	950
	550	750	650	750
	400	550	500	550
	350	450	400	450
		350	350	350
		300		300
	850	1200	950	1350
	600	850	750	900
	450	650	550	650
	350	500	450	500
		350	350	350
		300		300
	550	800	650	900
	400	600	500	600
	300	450	350	450
		300	300	300
	400	600	500	650
	300	450	350	450
		300		300

Table 11.5 64 and 96 Top hat fixings connections

Top hats connected to supports with 2 self drilling screws (12 size)

All spans/spacings calculated for roof edge loads

Spans/spacings need to be checked against top hat performance tables 11.1 and 11.2

Fasteners:

Metal support fasteners: 12 x 25mm hex head self drilling screws

Timber support fasteners: 12 x 25mm hex head Type 17 screws (add 10mm for softwood)

(Use 1.5mm metal support values for timber fixings)

Wind load	Top hat span (mm)	Single span spacing for support thickness (mm) shown						Double span spacing for support thickness (mm) shown						Double lapped span spacing for support thickness (mm) shown						Triple lapped span spacing for support thickness (mm) shown					
		1.0	1.2	1.5	1.9	2.4	3.0	1.0	1.2	1.5	1.9	2.4	3.0	1.0	1.2	1.5	1.9	2.4	3.0	1.0	1.2	1.5	1.9	2.4	3.0
N1	1500	2700	3000	3000	3000	3000	3000	900	1050	1450	1800	2100	2650	900	1000	1450	1750	2050	2600	1050	1200	1650	2050	2400	3000
	2000	2000	2300	2650	3000	3000	3000	700	800	1100	1350	1550	1950	650	750	1050	1300	1550	1950	750	900	1250	1550	1800	2200
	2500	1600	1800	2100	2650	3000	3000	550	600	850	1100	1250	1550	550	600	850	1050	1250	1550	600	700	1000	1200	1400	1800
	3000	1350	1500	1750	2200	2800	3000	450	500	700	900	1050	1300	450	500	700	850	1000	1300	500	600	800	1000	1200	1500
	3500	1150	1300	1500	1900	2400	3000	400	450	600	750	900	1100	350	400	600	750	850	1100	450	500	700	850	1000	1250
	4000	1000	1150	1300	1650	2100	2650	350	400	550	650	800	1000	300	350	500	650	750	950	350	450	600	750	900	1100
	4500	900	1000	1150	1450	1850	2350	300	350	450	600	700	850	300	300	450	600	650	850	350	400	550	650	800	1000
	5000	800	900	1050	1300	1700	2100	300	300	400	550	600	800	300	300	400	500	600	750	300	350	500	600	700	900
	5500	700	800	950	1200	1500	1900	400	400	500	500	550	700	350	350	450	550	550	700	300	300	450	550	650	800
	6000	650	750	850	1100	1400	1750	350	350	450	500	500	650	350	350	400	400	500	650	300	300	400	500	600	700
N2	1500	1950	2200	2550	3000	3000	3000	650	750	1050	1300	1500	1900	650	750	1050	1300	1500	1850	750	850	1200	1450	1700	2150
	2000	1450	1650	1900	2400	3000	3000	500	550	800	950	1150	1400	450	550	750	950	1100	1400	550	650	900	1100	1300	1600
	2500	1150	1300	1500	1900	2450	3000	400	450	600	750	900	1150	350	450	600	750	900	1100	450	500	700	850	1000	1300

3000	950	1100	1250	1600	2000	2550	300	350	500	650	750	950	300	350	500	600	750	900	350	400	600	700	850	1050
3500	800	950	1050	1350	1750	2150	300	450	550	650	800	800	300	300	450	550	600	800	300	350	500	600	700	900
4000	700	800	950	1200	1500	1900	400	400	450	550	700	700	350	350	450	550	700	700	300	300	450	550	650	800
4500	650	700	850	1050	1350	1700	350	350	400	500	600	600	350	350	400	500	600	600	350	350	400	450	550	700
5000	550	650	750	950	1200	1500	300	300	350	450	550	550	300	300	350	450	550	550	300	300	350	400	500	650
5500	500	600	650	850	1100	1350	350	350	400	500	500	500	350	350	400	500	500	500	300	300	300	400	450	550
6000	450	550	600	800	1000	1250	300	300	350	450	450	450	300	300	350	450	450	450	300	300	300	350	400	500
N3	1500	1250	1400	1600	2050	2600	400	450	650	800	950	1200	400	450	650	800	950	1200	450	550	750	950	1100	1350
2000	900	1050	1200	1550	1950	2450	300	350	500	600	700	900	300	350	500	600	700	900	350	400	550	700	800	1000
2500	750	850	950	1200	1550	1950	400	400	500	550	700	700	400	400	450	550	700	700	300	300	450	550	650	800
3000	600	700	800	1000	1300	1600	300	300	400	450	600	600	300	300	400	450	600	600	300	300	350	450	550	650
3500	500	600	700	850	1100	1400	350	350	400	500	500	500	350	350	400	500	500	500	300	300	300	400	450	550
4000	450	500	600	750	950	1200	300	300	350	450	450	450	300	300	350	450	450	450	300	300	350	400	450	500
4500	400	450	500	650	850	1050	300	300	300	300	300	400	300	300	300	300	300	400	300	300	300	350	450	450
5000	350	400	450	600	750	950	350	350	350	350	350	350	350	350	350	350	350	350	350	350	350	350	350	400
5500	300	350	400	550	700	850	300	300	300	300	300	300	300	300	300	300	300	300	300	300	300	300	300	350
6000	300	350	400	500	650	800	300	300	300	300	300	300	300	300	300	300	300	300	300	300	300	300	300	300

Table values continued on next page

Table 11.5 64 and 96 Top hat fixings connections

Continued from previous page

Wind load	Top hat span (mm)	Single span spacing for support thickness (mm) shown							Double span spacing for support thickness (mm) shown							Double lapped span spacing for support thickness (mm) shown							Triple lapped span spacing for support thickness (mm) shown						
		1.0	1.2	1.5	1.9	2.4	3.0	1.0	1.2	1.5	1.9	2.4	3.0	1.0	1.2	1.5	1.9	2.4	3.0	1.0	1.2	1.5	1.9	2.4	3.0				
N4	1500	800	950	1100	1350	1750	2200	300	450	550	550	650	800	300	450	550	600	600	800	300	350	500	600	700	900				
	2000	600	700	800	1000	1300	1650	300	400	400	450	600	300	400	400	450	600	350	450	550	550	650							
	2500	500	550	650	800	1050	1300	300	300	300	350	450	300	300	300	350	450	300	300	300	350	400	550						
	3000	400	450	550	650	850	1100	300	300	300	300	400	300	300	300	300	400	300	300	300	300	350	450						
	3500	350	400	450	550	750	900	350	350	350	350	350	300	300	300	300	300	250	250	300	300	300	350						
	4000	300	350	400	500	650	800	300	300	300	300	300	300	300	300	300	300	200	200	200	200	200	300						
	4500	300	300	350	450	550	700	300	300	300	300	300	300	300	300	300	300	300	300	300	300	300	300						
	5000	300	300	300	400	500	650	300	300	300	300	300	300	300	300	300	300	300	300	300	300	300	300						
	5500	300	300	300	350	450	600	300	300	300	300	300	300	300	300	300	300	300	300	300	300	300	300						
	6000	300	300	300	300	400	550	300	300	300	300	300	300	300	300	300	300	300	300	300	300	300	300						
N5	1500	550	600	700	900	1150	1450	300	300	350	450	550	300	350	400	400	550	350	400	500	500	600							
	2000	400	450	550	700	850	1100	300	300	300	300	400	300	300	300	300	400	300	300	350	350	450							
	2500	300	350	400	550	700	850	300	300	300	300	300	300	300	300	300	300	300	300	300	300	350							
	3000	300	300	350	450	550	700	300	300	300	300	300	300	300	300	300	300	300	300	300	300	300							
	3500	300	300	300	400	500	600	300	300	300	300	300	300	300	300	300	300	300	300	300	300	300	300						

4000	350	400	550	350	400	550	350
4500	300	350	450	300	350	450	300
5000		350	400	300	400	400	300
5500		300	400	300	400	400	300
6000			350	350	400	450	350
N6							
1500	400	450	550	700	850	1100	300
2000	300	350	400	500	650	800	400
2500		300	300	400	500	650	300
3000				350	400	550	400
3500				300	350	450	300
4000					300	400	400
4500						350	300
5000						300	300
5500						300	300
6000							

Table 11.6 64 and 96 Top hat fixings connections
Top hats connected to supports with 4 self drilling screws (12 size)

All spans/spacings calculated for roof edge loads

Spans/spacings need to be checked against top hat performance tables 11.1 and 11.2

Fasteners:

Metal support fasteners: 12 x 25mm hex head self drilling screws

Timber support fasteners: 12 x 25mm hex head Type 17 screws (add 10mm for softwood)
(Use 1.5mm metal support values for timber fixings)

Wind load	Top hat span (mm)	Single span spacing for support thickness (mm) shown							Double span spacing for support thickness (mm) shown							Triple lapped span spacing for support thickness (mm) shown									
		1.0	1.2	1.5	1.9	2.4	3.0	1.0	1.2	1.5	1.9	2.4	3.0	1.0	1.2	1.5	1.9	2.4	3.0	1.0	1.2	1.5	1.9	2.4	3.0
N1	1500	3000	3000	3000	3000	3000	3000	1200	1350	1900	2350	2750	3000	1150	1350	1900	2300	2700	3000	1350	1550	2150	2650	3000	3000
	2000	2600	2950	3000	3000	3000	3000	900	1000	1450	1750	2050	2550	850	1000	1400	1750	2000	2500	1000	1150	1600	2000	2300	2900
	2500	2100	2350	2750	3000	3000	3000	700	800	1150	1400	1650	2050	700	800	1100	1400	1600	2000	800	900	1300	1600	1850	2300
	3000	1750	1950	2300	2900	3000	3000	600	650	950	1150	1350	1700	550	650	950	1150	1350	1650	650	750	1050	1300	1550	1950
	3500	1500	1700	1950	2500	3000	3000	500	550	800	1000	1150	1450	500	550	800	1000	1150	1450	550	650	900	1150	1300	1650
	4000	1300	1450	1700	2150	2750	3000	450	500	700	850	1000	1300	400	500	700	850	1000	1250	500	550	800	1000	1150	1450
	4500	1150	1300	1500	1900	2450	3000	400	450	600	750	900	1150	350	450	600	750	900	1100	450	500	700	850	1000	1300
	5000	1050	1150	1350	1750	2200	2750	350	400	550	700	800	1000	300	350	500	700	800	1000	400	450	650	800	900	1150
	5500	950	1050	1250	1550	2000	2500	300	350	500	650	750	900	300	350	500	600	700	900	350	400	550	700	850	1050
	6000	850	950	1150	1450	1800	2300	300	300	450	550	650	850	300	300	450	550	650	800	300	350	500	650	750	950
N2	1500	2500	2850	3000	3000	3000	3000	850	950	1400	1700	1950	2450	850	950	1350	1650	1950	2400	950	1100	1550	1900	2250	2800
	2000	1900	2150	2450	3000	3000	3000	650	750	1050	1250	1450	1850	600	700	1000	1250	1450	1800	700	800	1150	1450	1650	2100
	2500	1500	1700	1950	2500	3000	3000	500	600	800	1000	1200	1450	500	550	800	1000	1150	1450	550	650	900	1150	1350	1650

3000	1250	1400	1650	2100	2650	3000	400	500	650	850	950	1200	400	450	650	800	950	1200	450	550	750	950	1100	1400
3500	1050	1200	1400	1800	2250	2850	350	400	600	700	850	1050	350	400	550	700	800	1000	400	450	650	800	950	1200
4000	950	1050	1200	1550	1950	2450	300	350	500	600	750	900	300	350	500	600	700	900	350	400	550	700	800	1050
4500	800	950	1100	1400	1750	2200	300	300	450	550	650	800	300	300	450	550	650	800	300	350	500	600	750	900
5000	750	850	950	1250	1550	1950	300	300	400	500	600	750	300	300	400	500	550	700	300	300	450	550	650	800
5500	650	750	900	1150	1450	1800	350	350	450	500	650	650	350	350	450	500	500	650	300	300	400	500	600	750
6000	600	700	800	1050	1300	1650	350	350	400	500	600	600	300	300	400	450	600	600	300	350	400	550	700	700
N3	1500	1600	1800	2100	2700	3000	3000	550	600	900	1100	1550	550	600	850	1050	1250	1550	600	700	1000	1200	1400	1800
2000	1200	1350	1600	2000	2550	3000	400	450	650	800	950	1150	400	450	650	800	900	1150	450	500	750	900	1050	1350
2500	950	1100	1250	1600	2000	2550	300	350	500	650	750	950	300	350	500	600	750	900	350	400	600	700	850	1050
3000	800	900	1050	1350	1700	2100	300	300	400	550	600	750	300	300	400	500	600	750	300	350	500	600	700	900
3500	650	750	900	1150	1450	1800	350	350	450	500	650	650	350	350	450	500	650	650	300	300	400	500	600	750
4000	600	650	750	1000	1250	1550	300	300	400	450	600	600	300	300	400	450	550	550	350	350	450	500	650	650
4500	500	600	700	900	1100	1400	350	350	400	500	500	500	350	350	400	500	500	500	300	300	400	450	600	600
5000	450	550	600	800	1000	1250	300	300	350	450	450	450	300	300	350	450	450	450	300	300	400	450	500	500
5500	400	500	550	700	900	1150	300	300	350	400	400	400	300	300	350	400	400	400	300	300	400	450	500	500
6000	400	450	500	650	850	1050	300	300	350	400	300	350	300	300	350	400	400	350	300	350	400	450	500	450

Table values continued on next page

Table 11.6 64 and 96 Top hat fixings connections

Continued from previous page

Wind load	Top hat span (mm)	Single span spacing for support thickness (mm) shown							Double span spacing for support thickness (mm) shown							Double lapped span spacing for support thickness (mm) shown							Triple lapped span spacing for support thickness (mm) shown																	
		1.0	1.2	1.5	1.9	2.4	3.0	3.0	1.0	1.2	1.5	1.9	2.4	3.0	3.0	1.0	1.2	1.5	1.9	2.4	3.0	3.0	1.0	1.2	1.5	1.9	2.4	3.0	3.0											
N4	1500	1050	1200	1400	1800	2250	2850	350	400	600	700	850	1050	1050	350	400	550	700	800	1050	1050	350	400	550	700	800	1050	1050	400	450	650	800	950	1200	1200					
	2000	800	900	1050	1350	1700	2100	300	450	550	600	800	800	300	400	500	600	750	750	300	350	500	600	700	900	900	300	350	500	600	700	900	900							
	2500	650	700	850	1050	1350	1700	350	400	500	600	600	600	350	400	500	600	600	350	400	500	600	600	700	700	400	400	500	550	700	700	700								
	3000	500	600	700	900	1100	1400	300	350	400	500	500	500	300	350	400	500	500	300	350	400	500	500	600	600	300	300	400	450	600	600	600								
	3500	450	500	600	750	950	1200	300	350	450	500	500	500	300	350	450	500	500	300	350	450	500	500	600	600	350	350	450	500	600	600	600								
	4000	400	450	500	650	850	1050	300	350	400	500	500	500	300	350	400	500	500	300	350	400	500	500	600	600	300	300	400	450	600	600	600								
	4500	350	400	450	600	750	950	350	400	500	600	600	600	350	400	500	600	600	350	400	500	600	600	700	700	350	350	450	500	600	600	600								
	5000	300	350	400	500	650	850	300	350	400	500	500	500	300	350	400	500	500	300	350	400	500	500	600	600	300	300	400	450	600	600	600								
	5500	300	350	450	600	750	750	300	350	450	600	600	600	300	350	450	600	600	300	350	450	600	600	700	700	300	300	400	450	600	600	600								
	6000	300	350	450	550	700	700	300	350	450	550	700	700	300	350	450	550	700	300	350	450	550	700	700	700	300	300	400	450	600	600	600								
N5	1500	700	800	950	1200	1550	1900	400	500	550	700	700	400	450	550	700	700	400	450	550	700	700	400	450	550	700	700	300	300	450	550	650	800	800						
	2000	550	600	700	900	1150	1450	300	350	400	500	500	300	350	400	500	500	300	350	400	500	500	300	300	400	450	600	600	600	300	300	400	450	600	600	600				
	2500	400	500	550	700	900	1150	300	300	350	400	400	300	350	400	400	250	300	300	400	400	250	300	300	350	450	450	450	300	300	350	450	450	450	450					
	3000	350	400	450	600	750	950	350	400	450	600	600	350	400	450	600	600	200	200	200	300	350	350	200	200	300	300	400	400	400	300	300	350	400	400	400	400			
	3500	300	350	400	500	650	800	300	350	400	500	500	300	350	400	500	500	300	350	400	500	500	300	350	400	500	500	300	300	400	450	600	600	600	300	300	400	450	600	600

Table 11.7 64 and 96 Top hat fixings connections
Top hats connected to supports with 2 self drilling screws (14 size)

All spans/spacings calculated for roof edge loads

Spans/spacings need to be checked against top hat performance tables 11.1 and 11.2

Fasteners:

Metal support fasteners: 14 x 25mm hex head self drilling screws

Timber support fasteners: 14 x 25mm hex head Type 17 screws (add 10mm for softwood)
(Use 1.5mm metal support values for timber fixings)

Wind load	Top hat span (mm)	Single span spacing for support thickness (mm) shown						Double span spacing for support thickness (mm) shown						Double lapped span spacing for support thickness (mm) shown						Triple lapped span spacing for support thickness (mm) shown					
		1.0	1.2	1.5	1.9	2.4	3.0	1.0	1.2	1.5	1.9	2.4	3.0	1.0	1.2	1.5	1.9	2.4	3.0	1.0	1.2	1.5	1.9	2.4	3.0
N1	1500	3000	3000	3000	3000	3000	3000	1100	1250	1750	2150	2500	3000	1050	1200	1700	2100	2450	3000	1200	1400	1950	2400	2800	3000
	2000	2350	2700	3000	3000	3000	3000	800	900	1300	1600	1850	2350	800	900	1250	1550	1800	2300	900	1050	1450	1800	2100	2650
	2500	1900	2150	2500	3000	3000	3000	650	750	1050	1300	1500	1850	650	700	1000	1250	1450	1800	700	850	1150	1450	1650	2100
	3000	1550	1800	2050	2600	3000	3000	550	600	850	1050	1250	1550	500	600	850	1050	1200	1500	600	700	950	1200	1400	1750
	3500	1350	1550	1750	2250	2850	3000	450	500	750	900	1050	1300	450	500	700	900	1050	1300	500	600	850	1000	1200	1500
	4000	1150	1350	1550	1950	2500	3000	400	450	650	800	900	1150	400	450	600	750	900	1150	450	500	700	900	1050	1300
	4500	1050	1200	1350	1750	2200	2750	350	400	550	700	800	1000	350	400	550	700	800	1000	400	450	650	800	900	1150
	5000	950	1050	1250	1550	2000	2500	300	350	500	650	750	900	300	350	500	600	700	900	350	400	550	700	800	1050
	5500	850	950	1100	1400	1800	2250	300	300	450	550	650	850	300	300	450	550	650	800	300	350	500	650	750	950
	6000	750	900	1000	1300	1650	2050	300	300	400	500	600	750	300	300	400	500	600	750	300	350	450	600	700	850
N2	1500	2300	2600	3000	3000	3000	3000	750	900	1250	1550	1800	2250	750	850	1200	1500	1750	2200	900	1000	1400	1750	2000	2550
	2000	1700	1950	2250	2850	3000	3000	600	650	950	1150	1350	1650	550	650	900	1100	1300	1650	650	750	1050	1300	1500	1900
	2500	1350	1550	1800	2250	2900	3000	450	500	750	900	1050	1350	450	500	700	900	1050	1300	500	600	850	1050	1200	1500

	3000	1150	1300	1500	1900	2400	3000	400	450	600	750	900	1100	350	400	600	750	850	1100	450	500	700	850	1000	1250
	3500	950	1100	1250	1600	2050	2550	300	350	500	650	750	950	300	350	500	650	750	950	350	400	600	750	850	1050
	4000	850	950	1100	1400	1800	2250	300	300	450	550	650	850	300	450	550	650	800	300	300	350	500	650	750	950
	4500	750	850	1000	1250	1600	2000	300	300	400	500	600	750	300	400	500	550	700	300	300	300	450	550	650	850
	5000	650	750	900	1100	1450	1800	350	350	450	500	650	650	300	350	450	500	650	300	300	300	400	500	600	750
	5500	600	700	800	1000	1300	1600	300	300	400	450	600	600	300	400	400	450	600	300	300	350	450	550	650	650
	6000	550	650	750	950	1200	1500	300	300	350	450	550	550	300	350	400	450	550	300	350	350	400	500	600	600
N3	1500	1450	1650	1900	2450	3000	3000	500	550	800	1000	1150	1450	500	550	750	950	1100	1400	550	650	900	1100	1300	1600
	2000	1100	1250	1450	1800	2300	2900	350	400	600	750	850	1050	350	400	600	700	850	1050	400	450	650	800	950	1200
	2500	850	1000	1150	1450	1850	2300	300	300	450	600	650	850	300	300	450	550	650	850	300	350	550	650	750	950
	3000	700	800	950	1200	1500	1900	400	400	500	550	700	700	350	450	550	700	700	700	300	300	450	550	650	800
	3500	600	700	800	1050	1300	1650	300	300	400	450	600	600	300	400	400	450	600	600	300	350	350	450	550	700
	4000	550	600	700	900	1150	1450	300	300	350	400	500	500	300	350	400	500	500	500	300	300	300	400	450	600
	4500	450	550	600	800	1000	1250	300	300	300	350	450	450	300	300	350	450	450	450	300	300	300	350	400	500
	5000	400	500	550	700	900	1150	300	300	300	300	400	400	300	300	300	400	300	400	300	300	300	300	350	450
	5500	400	450	500	650	800	1050	300	300	300	350	350	350	300	300	350	350	300	350	300	300	300	300	350	400
	6000	350	400	450	600	750	950	350	350	350	450	350	350	350	350	400	450	350	350	350	350	350	350	350	400

Table values continued on next page

Table 11.7 64 and 96 Top hat fixings connections

Continued from previous page

Wind load	Top hat span (mm)	Single span spacing for support thickness (mm) shown							Double span spacing for support thickness (mm) shown							Double lapped span spacing for support thickness (mm) shown							Triple lapped span spacing for support thickness (mm) shown											
		1.0	1.2	1.5	1.9	2.4	3.0	3.0	1.0	1.2	1.5	1.9	2.4	3.0	3.0	1.0	1.2	1.5	1.9	2.4	3.0	3.0	1.0	1.2	1.5	1.9	2.4	3.0	3.0					
N4	1500	950	1100	1300	1600	2050	2600	300	350	500	650	750	950	950	300	350	500	650	750	950	950	300	350	500	600	750	850	1100	350	400	600	750	850	1100
	2000	700	800	950	1200	1550	1950	400	500	500	500	550	700	700	400	450	450	450	550	700	700	300	450	550	550	650	800	800	300	300	450	550	650	800
	2500	550	650	750	950	1200	1550	300	400	400	450	550	550	550	300	350	350	450	550	550	550	300	350	350	350	450	500	650	300	300	300	300	400	550
	3000	450	550	650	800	1000	1300	300	300	300	350	450	450	450	300	300	300	350	450	450	450	300	300	300	300	350	400	550	300	300	300	300	400	550
	3500	400	450	550	700	850	1100	300	300	300	300	400	400	400	300	300	300	300	400	400	400	300	300	300	300	350	450	450	300	300	300	300	350	450
	4000	350	400	450	600	750	950	300	350	350	450	550	550	550	300	350	350	450	550	550	550	300	350	350	350	400	500	550	300	300	300	300	350	450
	4500	300	350	400	500	650	850	300	350	350	450	550	550	550	300	350	350	450	550	550	550	300	350	350	350	400	500	550	300	300	300	300	350	450
	5000	300	300	350	450	600	750	300	300	300	350	450	450	450	300	300	300	350	450	450	450	300	300	300	300	350	400	500	300	300	300	300	350	450
	5500	300	300	350	400	550	700	300	300	300	350	450	450	450	300	300	300	350	450	450	450	300	300	300	300	350	400	500	300	300	300	300	350	450
	6000	300	300	350	400	500	650	300	300	300	350	450	450	450	300	300	300	350	450	450	450	300	300	300	300	350	400	500	300	300	300	300	350	450
N5	1500	650	750	850	1100	1400	1750	350	450	450	500	500	650	650	350	400	400	500	500	650	650	300	400	400	500	500	550	700	300	400	400	500	550	700
	2000	500	550	650	800	1050	1300	300	300	300	350	450	450	450	300	300	300	350	450	450	450	300	300	300	300	350	400	550	300	300	300	350	400	550
	2500	400	450	500	650	800	1050	300	300	300	300	350	350	350	300	300	300	300	300	350	350	300	300	300	300	300	350	400	300	300	300	300	350	400
	3000	300	350	400	550	700	850	300	300	300	350	450	450	450	300	300	300	350	450	450	450	300	300	300	300	300	350	400	300	300	300	300	350	400
	3500	300	300	350	450	600	750	300	300	300	350	450	450	450	300	300	300	350	450	450	450	300	300	300	300	300	350	400	300	300	300	300	350	400

Table 11.8 64 and 96 Top hat fixings connections
Top hats connected to supports with 4 self drilling screws (14 size)

All spans/spacings calculated for roof edge loads

Spans/spacings need to be checked against top hat performance tables 11.1 and 11.2

Fasteners:

Metal support fasteners: 14 x 25mm hex head self drilling screws

Timber support fasteners: 14 x 25mm hex head Type 17 screws (add 10mm for softwood)
(Use 1.5mm metal support values for timber fixings)

Wind load	Top hat span (mm)	Single span spacing for support thickness (mm) shown						Double span spacing for support thickness (mm) shown						Triple lapped span spacing for support thickness (mm) shown											
		1.0	1.2	1.5	1.9	2.4	3.0	1.0	1.2	1.5	1.9	2.4	3.0	1.0	1.2	1.5	1.9	2.4	3.0						
N1	1500	3000	3000	3000	3000	3000	3000	1300	1450	2050	2550	2950	3000	1250	1450	2000	2500	2900	3000	1450	1650	2350	2850	3000	3000
	2000	2800	3000	3000	3000	3000	3000	950	1100	1550	1900	2200	2750	950	1050	1500	1850	2150	2700	1100	1250	1750	2150	2500	3000
	2500	2250	2550	2950	3000	3000	3000	750	850	1250	1500	1750	2200	750	850	1200	1500	1750	2150	850	1000	1400	1700	2000	2500
	3000	1850	2150	2450	3000	3000	3000	650	750	1000	1250	1450	1850	600	700	1000	1250	1450	1800	700	800	1150	1400	1650	2100
	3500	1600	1800	2100	2650	3000	3000	550	600	850	1050	1250	1550	550	600	850	1050	1250	1550	600	700	1000	1200	1400	1750
	4000	1400	1600	1850	2350	2950	3000	450	550	750	950	1100	1400	450	500	750	900	1050	1350	550	600	850	1050	1250	1550
	4500	1250	1400	1650	2050	2600	3000	400	450	650	850	950	1200	400	450	650	800	950	1200	450	550	750	950	1100	1400
	5000	1100	1250	1450	1850	2350	2950	350	400	600	750	850	1100	350	400	600	750	850	1050	400	500	700	850	1000	1250
	5500	1000	1150	1350	1700	2150	2700	350	400	550	700	800	1000	350	350	550	650	750	950	400	450	600	750	900	1100
	6000	900	1050	1200	1550	1950	2450	300	350	500	600	750	900	300	350	500	600	700	900	350	400	550	700	800	1000
N2	1500	2700	3000	3000	3000	3000	3000	900	1050	1500	1850	2150	2650	900	1050	1450	1800	2100	2600	1050	1200	1700	2050	2400	3000
	2000	2050	2300	2650	3000	3000	3000	700	800	1100	1350	1600	2000	650	750	1100	1350	1550	1950	800	900	1250	1550	1800	2250
	2500	1600	1850	2150	2700	3000	3000	550	600	900	1100	1250	1600	550	600	850	1050	1250	1550	600	700	1000	1250	1450	1800

3000	1350	1550	1750	2250	2850	3000	450	500	750	900	1050	1300	450	500	700	900	1050	1300	500	600	850	1000	1200	1500	
3500	1150	1300	1500	1900	2450	3000	400	450	600	750	900	1100	350	450	600	750	900	1100	450	500	700	850	1000	1300	
4000	1000	1150	1300	1700	2150	2650	350	400	550	650	800	1000	300	350	550	650	750	950	400	450	600	750	900	1100	
4500	900	1000	1150	1500	1900	2350	300	350	500	600	700	850	300	350	450	600	700	850	350	400	550	650	800	1000	
5000	800	900	1050	1350	1700	2150	300	450	550	600	800	300	300	400	500	600	750	300	350	500	600	700	900	300	
5500	700	800	950	1200	1550	1950	400	400	500	550	700	400	400	450	550	700	300	300	300	450	550	650	800	300	
6000	650	750	850	1100	1400	1750	350	350	450	500	650	350	350	450	500	650	300	300	300	400	400	500	600	750	
N3	1500	1750	1950	2250	2900	3000	3000	600	650	950	1150	1350	1700	550	650	900	1150	1350	1650	650	750	1050	1300	1550	1900
2000	1300	1450	1700	2150	2750	3000	450	500	700	850	1000	1250	400	500	700	850	1000	1250	500	550	800	1000	1150	1450	
2500	1050	1150	1350	1700	2200	2750	350	400	550	700	800	1000	350	400	550	650	800	1000	400	450	650	800	900	1150	
3000	850	950	1100	1450	1800	2250	300	300	450	550	650	850	300	300	450	550	650	800	300	350	500	650	750	950	
3500	750	850	950	1200	1550	1950	400	400	500	550	700	400	400	450	550	700	300	300	300	450	550	650	800	300	
4000	650	700	850	1050	1350	1700	350	350	400	500	600	600	350	350	400	500	500	600	400	400	500	550	700	400	
4500	550	650	750	950	1200	1500	300	300	350	450	550	550	300	300	350	450	550	550	300	350	400	500	600	600	
5000	500	550	650	850	1100	1350	350	350	400	400	500	500	350	350	400	500	500	500	350	350	400	450	550	550	
5500	450	500	600	750	1000	1250	400	400	500	600	700	450	300	300	350	450	450	450	300	300	350	400	500	500	
6000	400	450	550	700	900	1100	300	300	350	450	500	400	300	300	350	450	300	300	300	350	400	450	500	450	

Table values continued on next page

Table 11.8 64 and 96 Top hat fixings connections

Continued from previous page

Wind load	Top hat span (mm)	Single span spacing for support thickness (mm) shown									Double span spacing for support thickness (mm) shown									Double lapped span spacing for support thickness (mm) shown									Triple lapped span spacing for support thickness (mm) shown								
		1.0	1.2	1.5	1.9	2.4	3.0	1.0	1.2	1.5	1.9	2.4	3.0	1.0	1.2	1.5	1.9	2.4	3.0	1.0	1.2	1.5	1.9	2.4	3.0												
N4	1500	1150	1300	1500	1950	2450	3000	400	450	650	750	900	1150	400	450	600	750	900	1100	400	450	600	700	900	1000	1300	450	500	700	900	1000	1300					
	2000	850	1000	1150	1450	1850	2300	300	300	450	550	650	850	300	300	450	550	650	850	300	350	550	550	650	750	950	300	350	550	650	750	950					
	2500	700	800	900	1150	1450	1850		350	450	550	650	650		350	450	500	500	650		300	400	400	500	600	750		300	400	500	600	750					
	3000	550	650	750	950	1200	1500		300	400	450	550	550		300	300	350	450	550		300	350	350	450	500	650		350	450	500	650	650					
	3500	500	550	650	800	1050	1300			300	350	450	450				300	350	450				300	350	400	550		300	350	400	550	550					
	4000	400	500	550	700	900	1150				300	400	400					300	400					300	400	450		300	350	400	450	450					
	4500	350	400	500	650	800	1000					300	350					300	350					300	350	400		300	300	300	300	400					
	5000	350	400	450	550	700	900						300						300						300	350		300	300	300	300	350					
	5500	300	350	400	500	650	800						300						300							300		300	250	350	350	350					
	6000		300	350	450	600	750						250						250							300		250	250	300	300	300					
N5	1500	800	900	1000	1300	1650	2050		300	400	500	600	750		300	400	500	600	750		300	400	450	600	700	850		300	350	450	600	850					
	2000	600	650	750	950	1250	1550			300	400	450	550			300	350	450	550			300	350	450	500	650			350	450	500	650					
	2500	450	500	600	750	1000	1250				300	350	450				300	350	450				300	350	400	500			350	400	500	500					
	3000	400	450	500	650	800	1000					300	350					300	350					300	350	400			300	350	400	400					
	3500	300	350	400	550	700	850						300						300						300	350			300	350	400	350					

Table 11.9 120 Top hat connections

Top hats connected to supports with 2 self drilling screws (14 size)

All spans/spacings calculated for roof edge loads

Spans/spacings need to be checked against top hat performance table 11.3

Fasteners:

Metal support fasteners: 14 x 25mm hex head self drilling screws

Timber support fasteners: 14 x 25mm hex head Type 17 screws (add 10mm for softwood)

(Use 1.5mm metal support values for timber fixings)

Wind load	Top hat span (mm)	Single span spacing for support thickness (mm) shown							Double span spacing for support thickness (mm) shown							Double lapped span spacing for support thickness (mm) shown							Triple lapped span spacing for support thickness (mm) shown									
		1.2	1.5	1.9	2.4	3.0	850	950	1250	1550	1950	850	950	1250	1550	1950	850	950	1250	1550	1950	850	950	1250	1550	1950	850	950	1250	1550	1950	
N1	2500	2100	2450	3000	3000	3000	700	800	1000	1300	1600	700	800	1000	1300	1600	850	950	1250	1550	1950	850	950	1250	1550	1950	850	950	1250	1550	1950	
	3000	1750	2050	2600	3000	3000	600	700	850	1100	1400	600	700	850	1100	1400	700	800	1000	1300	1600	700	800	1000	1300	1600	700	800	1000	1300	1600	
	3500	1500	1750	2200	2800	3000	500	600	750	950	1200	500	600	750	950	1200	600	700	850	1100	1400	600	700	850	1100	1400	600	700	850	1100	1400	
	4000	1300	1500	1950	2450	3000	450	500	650	850	1050	450	500	650	850	1050	500	600	750	950	1200	500	600	750	950	1200	500	600	750	950	1200	
	4500	1150	1350	1700	2150	2700	400	450	600	750	950	400	450	600	750	950	450	500	650	850	1050	400	450	600	750	950	400	450	600	750	950	
	5000	1050	1200	1550	1950	2450	350	400	550	700	850	350	400	550	700	850	400	450	600	750	950	400	450	600	750	950	400	450	600	750	950	
	5500	950	1100	1400	1750	2200	350	400	500	650	800	350	400	500	650	800	350	400	550	700	850	350	400	550	700	850	350	400	550	700	850	
	6000	850	1000	1300	1600	2050	600	700	900	1100	1400	600	700	900	1100	1400	350	400	500	650	800	350	400	500	650	800	350	400	500	650	800	
	N2	2500	1500	1750	2250	2850	3000	500	550	750	950	1150	500	550	750	950	1150	600	700	900	1100	1400	600	700	900	1100	1400	700	800	1000	1250	1600
		3000	1250	1450	1850	2350	2950	400	500	600	800	1000	400	500	600	800	1000	500	550	750	950	1150	500	550	750	950	1150	550	650	850	1050	1350
		3500	1100	1250	1600	2000	2500	350	400	550	700	850	350	400	550	700	850	400	500	600	800	1000	400	500	600	800	1000	500	550	700	900	1150
		4000	950	1100	1400	1750	2200	300	350	500	600	750	300	350	500	600	750	350	400	550	700	850	400	500	600	800	1000	400	500	600	800	1000
4500		850	950	1250	1550	1950	300	350	450	550	700	300	350	500	600	750	300	350	500	600	750	350	450	550	700	850	350	450	550	700	900	
5000		750	850	1100	1400	1750	300	300	400	500	600	300	300	400	500	600	300	350	450	550	700	300	350	450	550	700	350	400	500	600	800	
5500		700	800	1000	1250	1600	350	350	450	550	650	350	350	450	550	650	300	300	400	500	600	300	300	400	500	600	300	350	450	550	700	
6000		600	700	900	1150	1450	350	450	550	650	750	350	450	550	650	750	350	400	500	600	700	350	450	550	650	750	300	300	400	500	600	

N3	2500	950	1100	1400	1800	2250	350	450	550	700	900	350	450	550	700	900	450	500	650	800	1000		
	3000	800	950	1200	1500	1900	300	350	450	600	750	300	350	450	600	750	350	400	500	650	850		
	3500	700	800	1000	1300	1600	300	400	500	650	800	300	400	500	650	800	300	350	450	550	700		
	4000	600	700	900	1100	1400		350	450	550	700	350	450	550	700	850	350	400	500	600	750		
	4500	550	600	800	1000	1250		300	400	500	650	300	400	500	650	800	300	350	450	550	700		
	5000	450	550	700	900	1100			350	450	550	700		350	450	550	700		300	400	500	650	
	5500	450	500	650	800	1000			300	400	500	650			300	400	500			350	450	550	
	6000	400	450	600	750	950					300	350			300	350	400			300	400	500	
	N4	2500	650	750	950	1200	1500	300	350	450	600	750	300	350	450	600	750	300	300	400	500	650	
3000		550	600	800	1000	1250	300	400	500	650	800	300	400	500	650	800	300	350	450	550	700		
3500		450	500	650	850	1050		350	450	550	700		350	450	550	700		300	400	500	650		
4000		400	450	600	750	950		300	400	500	650		300	400	500	650			300	400	500		
4500		350	400	500	650	850																	
5000		300	350	450	600	750																	
5500		300	300	400	500	650																	
6000		300	300	400	500	600																	

Table values continued on next page

Table 11.9 120 Top hat connections

Continued from previous page

Wind load	Top hat span (mm)	Single span spacing for support thickness (mm) shown						Double span spacing for support thickness (mm) shown						Double lapped span spacing for support thickness (mm) shown						Triple lapped span spacing for support thickness (mm) shown						
		1.2	1.5	1.9	2.4	3.0	1.2	1.5	1.9	2.4	3.0	1.2	1.5	1.9	2.4	3.0	1.2	1.5	1.9	2.4	3.0	1.2	1.5	1.9	2.4	3.0
N5	2500	450	500	650	800	1000	300	300	300	400	400	300	300	300	300	400	300	300	300	300	400	300	300	300	300	450
	3000	350	400	550	650	850				300	300					300					300					350
	3500	300	350	450	550	700																				300
	4000		300	400	500	650																				
	4500			350	450	550																				
	5000			300	400	500																				
5500			300	350	450																					
6000				300	400																					
N6	2500	300	350	450	600	750																				350
	3000		300	400	500	600																				
	3500			300	400	550																				
	4000			300	350	450																				
	4500				300	400																				
	5000				300	350																				
5500					350																					
6000					300																					

Notes:

Table 11.10 120 Top hat connections

Top hats connected to supports with 4 self drilling screws (14 size)

All spans/spacings calculated for roof edge loads

Spans/spacings need to be checked against top hat performance table 11.4

Fasteners:

Metal support fasteners: 14 x 25mm hex head self drilling screws

Timber support fasteners: 14 x 25mm hex head Type 17 screws (add 10mm for softwood)

(Use 1.5mm metal support values for timber fixings)

Wind load	Top hat span (mm)	Single span spacing for support thickness (mm) shown						Double span spacing for support thickness (mm) shown						Double lapped span spacing for support thickness (mm) shown						Triple lapped span spacing for support thickness (mm) shown					
		1.2	1.5	1.9	2.4	3.0	1.2	1.5	1.9	2.4	3.0	1.2	1.5	1.9	2.4	3.0	1.2	1.5	1.9	2.4	3.0	1.2	1.5	1.9	2.4
N1	2500	2500	2900	3000	3000	3000	1000	1150	1450	1850	2300	1000	1150	1450	1850	2300	1100	1300	1650	2100	2600				
	3000	2100	2400	3000	3000	3000	800	950	1200	1550	1900	800	950	1200	1550	1900	950	1100	1350	1750	2200				
	3500	1800	2050	2600	3000	3000	700	800	1050	1300	1650	700	800	1050	1300	1650	800	900	1150	1500	1850				
	4000	1550	1800	2300	2900	3000	600	700	900	1150	1450	600	700	900	1150	1450	700	800	1000	1300	1650				
	4500	1400	1600	2000	2550	3000	550	600	800	1000	1250	550	600	800	1000	1250	600	700	900	1150	1450				
	5000	1250	1450	1800	2300	2900	500	550	700	900	1150	500	550	700	900	1150	550	650	800	1050	1300				
	5500	1100	1300	1650	2100	2600	450	500	650	800	1050	450	500	650	800	1050	500	600	750	950	1200				
	6000	1050	1200	1500	1900	2400	400	450	600	750	950	400	450	600	750	950	450	550	650	850	1100				
	N2	2500	1800	2100	2650	3000	3000	700	800	1050	1300	1650	700	800	1050	1300	1650	800	950	1200	1500	1900			
		3000	1500	1750	2200	2800	3000	600	700	850	1100	1400	600	700	850	1100	1400	650	750	1000	1250	1550			
		3500	1300	1500	1900	2400	3000	500	600	750	950	1200	500	600	750	950	1200	550	650	850	1050	1350			
		4000	1100	1300	1650	2100	2600	450	500	650	800	1050	450	500	650	800	1050	500	550	750	950	1150			
4500		1000	1150	1450	1850	2300	400	450	550	700	900	400	450	550	700	900	450	500	650	850	1050				
5000		900	1050	1300	1650	2100	350	400	500	650	800	350	400	500	650	800	400	450	600	750	950				
5500		800	950	1200	1500	1900	300	350	450	600	750	300	350	450	600	750	350	400	550	650	850				
6000		750	850	1100	1400	1750	350	400	550	700	900	300	350	400	550	700	300	350	500	600	750				

N3	2500	1150	1300	1700	2150	2650	450	500	650	850	1050	450	500	650	850	1050	500	600	750	950	1200	
	3000	950	1100	1400	1750	2200	350	400	550	700	850	350	400	550	700	850	400	500	600	800	1000	
	3500	800	950	1200	1500	1900	300	350	450	600	750	300	350	450	600	750	350	400	550	700	850	
	4000	700	800	1050	1300	1650	300	300	400	500	650	300	300	400	500	650	300	350	450	600	750	
	4500	600	700	900	1150	1450	350	350	450	550	550	350	350	450	550	550	300	300	400	500	650	
	5000	550	650	850	1050	1300	300	300	400	400	500	300	300	400	400	500	300	300	350	450	600	
	5500	500	600	750	950	1200	350	350	450	450	450	300	300	350	350	450	300	350	400	550	550	
	6000	450	550	700	850	1100	350	350	450	400	400	350	350	400	400	400	350	300	300	400	500	
	N4	2500	750	900	1100	1400	1800	300	350	450	550	700	300	350	450	550	700	350	400	500	650	800
		3000	650	750	950	1200	1500	300	300	350	450	600	300	300	350	450	600	300	300	400	500	650
3500		550	600	800	1000	1250	300	300	400	400	500	300	300	400	400	500	300	350	450	550	550	
4000		450	550	700	900	1100	350	350	450	450	450	350	350	450	450	450	300	300	300	400	500	
4500		400	500	600	800	1000	300	300	400	300	400	300	300	400	300	400	300	350	450	350	450	
5000		350	450	550	700	900	300	350	450	450	350	350	350	450	300	400	350	300	300	400	400	
5500		350	400	500	650	800	350	350	450	450	300	300	300	400	300	300	300	300	300	300	350	
6000		300	350	450	600	750	350	350	450	450	300	300	300	400	300	300	300	300	300	300	350	

Table values continued on next page

Table 11.10 120 Top hat connections

Continued from previous page

Wind load	Top hat span (mm)	Single span spacing for support thickness (mm) shown							Double span spacing for support thickness (mm) shown							Double lapped span spacing for support thickness (mm) shown							Triple lapped span spacing for support thickness (mm) shown						
		1.0	1.2	1.5	1.9	2.4	3.0	1.0	1.2	1.5	1.9	2.4	3.0	1.0	1.2	1.5	1.9	2.4	3.0	1.0	1.2	1.5	1.9	2.4	3.0				
N5	2500		350	450	550	700	900						350																
	3000		300	350	450	600	750						300																
	3500			300	400	500	650																						
	4000				350	450	550																						
	4500				300	400	500																						
	5000					350	450																						
	5500					300	400																						
	6000					300	350																						
	N6	2500			300	400	550	700																					
		3000				350	450	550																					
3500					300	400	500																						
4000						350	400																						
4500						300	350																						
5000							350	350																					
5500						300	300																						
6000						300	300																						

Notes:

Table 11.11 64 Top hat

All spans/spacings calculated for roof edge loads

Spans/spacings need to be checked for support fastener performance table 11.14

Spacings in red exceed the 1.4kN serviceability foot traffic load

Wind load	Top hat span (mm)	Single span spacing (mm)			Double lapped span spacing (mm)		
		64075	64100	64120	64075	64100	64120
C1	1500	1350	1800	2200	1250	1550	1850
	2000	600	900	1200	850	1150	1400
	2500	400	550	750	550	800	1000
	3000		400	500	350	550	700
	3500		300	350		400	500
	4000			300		300	400
	4500						300
	5000						
	5500						
C2	1500	900	1200	1450	850	1050	1250
	2000	400	600	800	550	750	950
	2500		350	500	350	500	650
	3000			350		350	450
	3500						350
	4000						
C3	1500	600	800	1000	550	700	850
	2000		400	550	350	500	600
	2500			350		350	450
	3000						300
	3500						
C4	1500	450	600	700	400	500	600
	2000		300	400		400	450
	2500						300
	3000						
	3500						

	Triple lapped span spacing (mm)		
	64075	64100	64120
	1400	1750	2150
	1000	1300	1600
	600	900	1200
	400	650	850
	300	450	600
		350	450
			350
			300
	950	1200	1400
	650	900	1050
	400	600	800
	300	400	550
		300	400
			300
	650	800	950
	450	600	700
		400	550
		300	350
	450	600	700
	300	450	500
		300	400

Table 11.12 96 Top hat

All spans/spacings calculated for roof edge loads

Spans/spacings need to be checked for support fastener performance table 11.14

Spacings in red exceed the 1.4kN serviceability foot traffic load

Wind load	Top hat span (mm)	Single span spacing (mm)			Double lapped span spacing (mm)		
		96075	96100	96120	96075	96100	96120
C1	1500	1550	1950	2350	1250	1550	1850
	2000	1150	1450	1750	900	1150	1400
	2500	550	800	1000	750	900	1100
	3000	350	550	700	550	750	900
	3500		400	500	400	650	800
	4000		300	400	300	550	700
	4500			300		450	550
	5000					350	450
	5500					300	350
C2	1500	1050	1300	1550	850	1050	1250
	2000	750	950	1150	600	750	950
	2500	350	550	700	500	600	750
	3000		350	450	350	500	600
	3500			350		450	500
	4000					350	450
	4500					300	350
C3	1500	700	900	1050	550	700	850
	2000	500	650	800	400	500	600
	2500		350	450	300	400	500
	3000			300		350	400
	3500					300	350
	4000						300
C4	1500	500	650	800	400	500	600
	2000	400	500	600	300	400	450
	2500			350		300	350
	3000						300
	3500						

	Triple lapped span spacing (mm)		
	96075	96100	96120
	1400	1750	2150
	1050	1300	1600
	850	1050	1250
	600	850	1050
	450	650	850
	300	500	650
		400	500
		300	400
			300
	950	1200	1400
	700	900	1050
	550	700	850
	400	600	700
	300	450	550
		300	400
			300
	650	800	950
	450	600	700
	350	450	550
		400	450
		300	350
			300
	450	600	700
	350	450	500
		350	400
		300	350

Table 11.13 120 Top hat

All spans/spacings calculated for roof edge loads

Spans/spacings need to be checked for support fastener performance table 11.14

Spacings in red exceed the 1.4kN serviceability foot traffic load

Wind load	Top hat span (mm)	Single span spacing (mm)		Double lapped span spacing (mm)	
		12070	12090	12070	12090
C1	2000	700	900	550	700
	2500	550	700	450	550
	3000	450	600	350	450
	3500	350	450	300	400
	4000		300		350
	4500				300
	5000				
	5500				
C2	2000	450	600	350	450
	2500	350	450	300	350
	3000	300	400		300
	3500		300		
	4000				
	4500				
C3	2000	300	400		300
	2500		300		
	3000				
	3500				
	4000				
C4	2000		300		
	2500				
	3000				
	3500				
	4000				

	Triple lapped span spacing (mm)	
	12070	12090
	650	800
	500	650
	400	550
	350	450
	300	400
		350
		300
		300
	400	550
	350	450
		350
		300
		350
		300

Table 11.14 64, 96 and 120 Top hat connections

Top hats connected to supports with 4 self drilling screws (14 size)

All spans/spacings calculated for roof edge loads

Spans/spacings need to be checked against top hat performance tables 11.11 to 11.13

Fasteners:

Metal support fasteners: 14 x 25mm hex head self drilling screws

Timber support fasteners: 14 x 25mm hex head Type 17 screws (add 10mm for softwood)
(Use 1.5mm metal support values for timber fixings)

Wind load	Top hat span (mm)	Single span spacing for support thickness (mm) shown							Double lapped span spacing for support thickness (mm) shown							Triple lapped span spacing for support thickness (mm) shown						
		1.0	1.2	1.5	1.9	2.4	3.0	1.0	1.2	1.5	1.9	2.4	3.0	1.0	1.2	1.5	1.9	2.4	3.0			
C1	1500	650	750	900	1150	1450	1800	450	500	750	900	1050	1300	500	600	850	1050	1200	1550			
	2000	500	550	650	850	1100	1350	350	400	550	700	800	1000	400	450	650	800	900	1150			
	2500	350	450	550	650	850	1100	300	450	450	550	600	800	300	350	500	600	700	900			
	3000	300	350	450	550	700	900	350	450	500	500	650	650	300	400	400	500	600	750			
	3500	300	300	350	450	600	750	300	300	350	450	550	550	350	450	500	500	600	650			
	4000	300	300	400	400	550	650	300	400	400	500	500	500	300	400	400	450	450	550			
	4500	300	300	350	450	450	600	300	350	350	450	450	450	350	400	400	450	450	500			
	5000	300	300	400	400	400	550	300	400	400	400	400	400	300	300	300	350	350	450			
	5500	300	300	400	400	400	500	300	400	400	400	400	400	350	400	400	400	400	400			
	6000	300	300	350	450	450	450	300	350	350	450	450	450	300	300	300	300	300	350			
C2	1500	450	500	600	750	950	1200	300	350	500	600	700	900	350	400	550	700	800	1000			
	2000	300	350	450	550	700	900	350	450	500	500	650	650	300	400	400	500	600	750			
	2500	300	300	350	450	550	700	300	300	300	350	400	500	350	350	350	400	500	600			
	3000	300	300	300	350	450	600	300	300	300	300	350	450	300	350	350	400	500	600			
	3500	300	300	300	300	400	500	300	300	300	300	300	350	300	300	300	350	400	500			
	4000	300	300	350	450	450	450	350	450	450	450	450	450	300	300	300	350	400	500			
	4500	300	300	300	350	450	400	300	350	350	450	450	450	300	300	300	350	400	500			
	5000	300	300	400	400	400	400	300	400	400	400	400	400	350	400	400	400	400	400			
	5500	300	300	400	400	400	500	300	400	400	400	400	400	350	400	400	400	400	400			
	6000	300	300	350	450	450	450	300	350	350	450	450	450	300	300	300	300	300	350			



12. Roof and Ceiling Battens

Tried and tested
timber alternative

STRAMIT® ROOF BATTENS HAVE BEEN DEVELOPED SPECIFICALLY FOR DOMESTIC APPLICATIONS, BUT MAY ALSO BE USED IN SMALL COMMERCIAL STRUCTURES

Our cyclonic roof battens are performance enhanced to endure the repeated loadings that can be experienced in tropical cyclones. Stramit® ceiling battens are used with plasterboard sheeting in both domestic and commercial structures.

Manufactured from high tensile steel, Stramit® battens provide excellent durability in most applications, but are not recommended for use in enclosed areas within 450mm of moist soil, or in marine or heavy industrial environments.

Please refer to your local Stramit branch to determine the size and thickness of the local roof batten.

Loadings

All loadings used in deriving the design data are assumed to either act uniformly along the top central flange of the sections or, for connections to support members, evenly between each of the lower flanges (feet).

Where used, foot traffic loadings, are based on NASH Standard Part 1.

Framing

Stramit can also supply cold formed steel sections that can be used for stud, plate and nogging frames. These conventional sections are easily assembled using standard techniques.

How to use the batten tables

These tables are based on roof edge loads and triple batten spans. For convenience, corner areas may be considered at one wind category higher in most cases. The tables return the cladding spans to allow direct comparisons with the cladding for design purposes.

- 1. Use the wind load category used previously for the cladding design.**
- 2. To suit the batten span, determine the batten spacing for the locally sourced roof batten.**
- 3. Ensure the correct fastener found at the top of the table is used to suit the sub-structure thickness.**
- 4. Stramit® roof battens can also support tiled roofs. Please refer to table 12.4 for the relevant performance of the local batten.**
- 5. Stramit® ceiling batten design data is found in table 12.3.**

Please refer to chapter 17 for a worked example on how to use the batten tables.

Summary Checklist

- ✔ Use the details from the table to suit the batten available from your local Stramit office
- ✔ Use the same wind load category as used previously for claddings
- ✔ Check against the batten span for support thickness
- ✔ Ensure the correct fasteners have been specified
- ✔ Double check the batten spacing is equal to or greater than the cladding spans designed previously
- ✔ For more information go to stramit.com.au/products/

Roof and Ceiling Battens

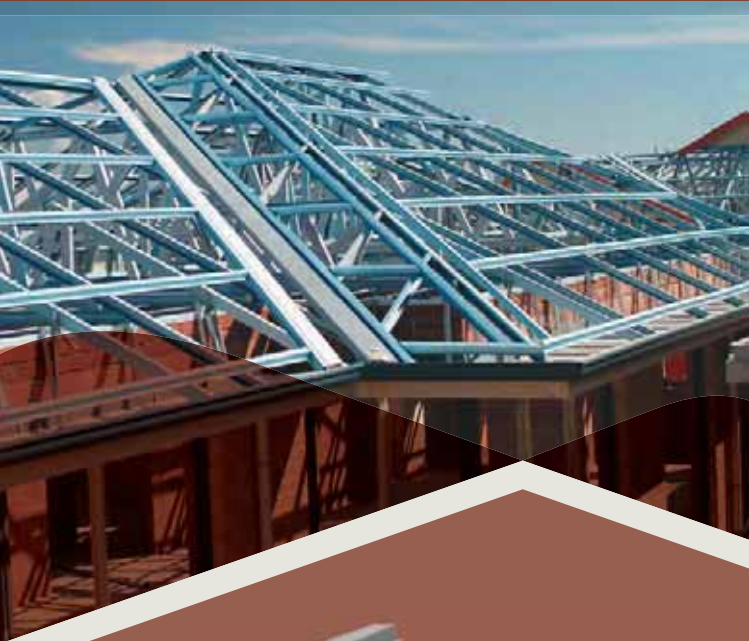

Ceiling batten



Batten

Stramit® roof and ceiling battens are strong, lightweight and won't buckle or warp.

- Durable, rot-free and fire-resistant
- Knurled anti-slip surfaces on roof and ceiling battens for quick and easy installation
- Rolled safety edges on roof and ceiling battens
- Easy to handle and store



Fasteners

The load tables have the recommended fasteners required to connect the battens to the supporting structure.

Fastening location

Fasteners are positioned through the bottom flanges on either side of the batten into the structure using a minimum of two per joint.

Performance

The maximum span to suit the design variables can be determined from the following tables. Note the batten spacing may be reduced based on the maximum sheeting span.

Table 12.1 Stramit® roof battens



Triple span spacing (or cladding span) (mm)

Fasteners:		For 1.0mm thick G550 supports Metal: 2x10 self drilling screws			For 1.5mm and thicker plus timber supports Metal: 2x12 self drilling screws Timber: 2x12 Type 17 screws		
Wind load	Batten span	Batten thickness (BMT mm)			Batten thickness (BMT mm)		
		0.48	0.55	0.75C	0.48	0.55	0.75C
N1	450	2250	2250	2250	2250	2250	2250
	600	2250	2250	2250	2250	2250	2250
	900	2250	2250	2250	2250	2250	2250
	1200		1840	1840		2250	2250
N2	450	2250	2250	2250	2250	2250	2250
	600	2250	2250	2250	2250	2250	2250
	900	1660	1780	1780	2250	2250	2250
	1200		1330	1330		2130	2130
N3	450	2130	2250	2250	2250	2250	2250
	600	1590	1710	1710	2210	2250	2250
	900	1060	1140	1140	1530	1590	1590
	1200		850	850		1360	1360
N4	450	1430	1530	1530	1990	1990	1990
	600	1070	1140	1140	1490	1590	1590
	900	710	760	760	1020	1070	1070
	1200		570	570		910	910
N5	450	970	1040	1040	1360	1350	1350
	600	730	780	780	1010	1080	1080
	900	480	520	520	700	730	730
	1200		390	390		620	620

Table 12.2 Stramit® roof battens



Triple span spacing (or cladding span) (mm)

Fasteners:		For 1.5mm thick G450 supports		Timber supports
		Metal: 2x12 self drilling screws	Metal 2x14 Self drilling screws	Timber 2x12 Type 17 screws
Wind load	Batten span	Batten thickness (BMT mm)		
		0.75C	0.75C	0.75C
C1	450	1430	1850	2130
	600	1070	1380	1600
	900	710	920	1060
	1200	530	690	800
C2	450	960	1240	1440
	600	720	930	1080
	900	480	620	720
	1200	360	460	540
C3	450	650	840	970
	600	490	630	730
	900	320	420	480
	1200		310	360
C4	450	480	620	720
	600	360	470	540
	900		310	360
	1200			

Table 12.3 Stramit® ceiling batten spans (mm)**Fasteners:**

Metal (1.0mm or thicker): 10x16mm SD hex head screws

Softwood (non-cyclonic): 10x20mm Type 17 hex head screws

Softwood (cyclonic): 10x25mm Type 17 hex head screws

For plasterboard fixing: 6x25mm bugle head SD screws

Plasterboard layers	Batten centres	Stramit ceiling batten	WA ceiling batten
1	450	1500	1550
	600	1400	1400
2	450	1250	1250
	600	1100	1150

Using 12mm plasterboard

Table 12.4 Stramit® roof battens

Tile roofs

Triple span (mm)

Centres (mm)	Batten thickness (mm)	
	0.48	0.55
300	600	900

Based on foot traffic requirements of NASH Standard Part 1

Notes:



13. Formwork

Suspended floor
slab construction
made easy

STRAMIT® CONDECK HP® COMPOSITE SLAB SYSTEM IS ONE OF THE BEST IN THE BUSINESS WHEN IT COMES TO DESIGNING AND INSTALLING PERMANENT METAL FORMWORK AND TENSILE REINFORCEMENT FOR SUSPENDED CONCRETE SLABS

It is ideal for floor slab construction in both steel frame and concrete frame construction, including band beam applications and post-tensioned slabs. While generally used in composite construction, Stramit's Condeck HP® decking component also provides effective formwork in conventional suspended slab applications.

Design overview

Stramit's Condeck HP® composite slab system is a quality roll formed galvanised decking that provides a working platform and support for the wet concrete during formwork stage, and becomes the tensile reinforcement within the slab. The efficiency of the system saves labour and improves cycle times during construction. The shape of the Condeck HP® profile assists in the placement of shear studs when required, and the closed rib improves the fire resistance of the slab. Following trades can benefit from the Stramit® ceiling hanger which attaches to the underside of the slab without fasteners. Design data for formwork, composite and fire design stages are all contained in Stramit's Condeck HP® composite slab system technical manual.

Formwork phase

The lightweight 300mm wide sheets are easily placed into position. Longer spans will require temporary props to support the construction loads and the wet concrete. Please refer to the technical manual for details of stacked construction loads and the resulting need for sidelap fasteners. Any reinforcing, or shrinkage and temperature mesh is easily laid on the deck, although slabs thicker than 125mm will require the use of reinforcement chairs. Concrete should be poured evenly over the deck and allowed to cure like a conventional slab. Props must not be removed until the concrete has cured and until advised by the site engineer.

Composite slab phase

The final slab performance is determined by the concrete compressive strength. Condeck HP® composite slab system slabs have solid slab performance with advantages in noise and heat transmission.

Fire design

The Stramit fire design procedure utilises the information from fire tests to determine the strength and reinforcing requirements of the finished slab.

Supports

Permanent supports, steel or concrete beams or walls need to be stable and of adequate strength to withstand the loadings.

Propping

Temporary propping, where required, supported on stable surface ground, must provide continuous transverse (across the sheet) supports, designed to take the loadings, at the prescribed spacings. The prop bearer width must be no less than 100mm, unless established by calculation.

Shear studs

Stramit's Condeck HP® composite slab system can accept the placement of shear studs at 100, 150, 200 or 300mm centres. Confirmed by independent tests and evaluation, this property enhances the design of composite steel beams beneath the deck.

How to use the Condeck HP® tables

For the purposes of *The Stramit Book of Answers*®, we have developed a single table that indicates the slab thickness to suit a single span application using 25MPa concrete. It also indicates the propping requirements.

1. Single table usage.

If you elect to use the single table, please note it is for single spans only, and all spans given are clear spans, i.e. distance between the supports.

Rib deflection in formwork mode has been limited to $L/240$, and total composite slab deflection is limited to $L/250$. No provision has been made to support masonry partitions etc. Should this be required, please refer to the Condeck HP® composite slab system technical manual.

The following points explain how to use the table:

- Select a live load to suit the application, and for the thickness of the Condeck HP® decking, find the clear span equal to or higher than the project.
- Read to the left of the table the thickness of the concrete slab required, and to the right, the size of the shrinkage and temperature reinforcement. This is required to

minimise surface cracking in the slab.

- Figures in red are not suitable for exposed ceilings. The slab will be structurally sound, but the underside of the decking will show some distortion.
- All slabs will require propping prior to the pouring of the wet concrete. The different shaded areas indicate the need for one or two rows of temporary propping.

2. For projects requiring multiple spans, negative steel reinforcement and fire design, please refer to the Condeck HP® composite slab system technical manual or use the purpose made Stramit Condeck HP® software.

3. Refer to Stramit's full suite of Condeck HP® performance tables if required.

For our performance tables, please refer to Stramit's Condeck HP® composite decking product technical manual. Alternatively, Stramit has purpose designed software for the Condeck HP® composite slab system that will calculate prop spacings, composite slab design and fire design quickly and easily.

Please refer to chapter 17 for a worked example on how to use the Condeck HP® single table that indicates the slab thickness to suit a single span application using 25MPa concrete.

Summary Checklist

- ✓ The simple table is only for single spans. For all other designs please refer to Stramit's Condeck HP® composite decking product technical manual or the Condeck HP® Software
- ✓ Ensure the correct live load has been selected
- ✓ Determine the slab thickness and temperature mesh sizing
- ✓ Use the correct amount of propping beneath the slab and keep it in place until the concrete has cured and the site engineer has approved its removal
- ✓ Use thicker Condeck HP® for better underside appearance
- ✓ For more information go to stramit.com.au/products

Condeck HP[®] Composite Slab System



Save time and money in suspended floor construction with Stramit's Condeck HP[®] composite slab system.

- Permanent metal formwork and tensile reinforcement for suspended concrete slabs
- Supplied to site cut to length for speedy installation
- Enclosed ribs provide fire resistance ratings up to 4 hours
- ZAM[®] material for additional life in exposed environments also available
- Stramit's Condeck HP[®] slab designer software available



AVAILABLE



NOT AVAILABLE



Accessories

The Condeck HP® slab system consists of Condeck HP® decking, available in 3 thicknesses: Condeck HP® Plus, an end span accessory that reduces the deflection in the end span during the formwork stage; Stramit® Edgeforma sections to close off the edges of the slab; and a two piece ceiling hanger system.

Performance

If you elect to use the single table, please note it is for **single spans only**, and all spans given are clear spans, i.e. distance between the supports.

Notes:

Table 13.1 Condeck HP® single slab using 25MPa concrete

All spans are clear spans

Values in red not suitable for exposed ceilings

Maximum single span (mm) using 25MPa concrete

Live load	1.5 kPa			3 kPa			
	Deck thickness (mm BMT)			Deck thickness (mm BMT)			
	0.75	0.90	1.00	0.75	0.90	1.00	
90	2440	2590	2640	2290	2440	2490	
100	2740	2840	2940	2590	2690	2790	
110	2940	3090	3140	2790	2940	2990	
120	3180	3280	3330	3020	3080	3180	
125	3275	3325	3425	3125	3175	3275	
130	3370	3470	3520	3220	3270	3370	
140	3610	3660	3710	3460	3510	3560	
150	3850	3850	3900	3650	3700	3750	
160	4090	4090	4090	3840	3890	3940	
170	4280	4280	4280	4080	4080	4130	
180	4520	4470	4470	4270	4270	4270	
190	4710	4710	4710	4460	4460	4510	
200	4900	4900	4900	4650	4650	4700	
210	5090	5090	5090	4840	4840	4840	
220	5280	5280	5280	5030	5030	5030	
230		5470	5470	5220	5220	5220	
240		5660	5660		5360	5410	
250		5850	5850		5550	5550	

- One row of props
- Two rows of props

Table is based on a 1.5kPa stacked material load and mesh placed on deck ribs for slab thicknesses up to 125mm.

For thicker slabs the top mesh needs to be placed near the top of the slab.

	5 kPa			Shrinkage and temperature reinforcement
	Deck thickness (mm BMT)			
	0.75	0.90	1.00	
	2190	2290	2290	SL62
	2440	2540	2590	SL62
	2640	2740	2790	SL62
	2830	2880	2980	SL62
	2925	3025	3075	SL62
	3020	3070	3170	SL62
	3210	3310	3360	SL72
	3400	3500	3550	SL72
	3640	3690	3740	SL82
	3830	3880	3930	SL82
	4020	4020	4070	SL82
	4210	4260	4260	SL92
	4400	4450	4450	SL92
	4590	4590	4640	SL92
	4780	4780	4780	SL92
	4970	4970	4970	SL102
		5160	5160	SL102
		5250	5300	SL102



14. Flooring

Single- and upper-
storey solutions

A COMPLETE SUB-FLOORING PACKAGE, STRAMIT® IN-PLANE STEEL FLOOR FRAMING SYSTEMS OFFER DESIGNERS THE FLEXIBILITY TO TAILOR SUSPENDED DESIGNS FOR SINGLE- AND UPPER-STORY DWELLINGS

A wide range of section sizes provides freedom in designing floor joists and bearers for most locations, with extended bearer options to provide larger span design possibilities.

The Stramit® Residential Floor Framing System is only suitable for residential construction and not intended, nor suitable, for use in any form of mezzanine, commercial, institutional, industrial, agricultural or any other form of non-residential construction unless engineered by others.

Bracing

Bracing of posts/piers must not be connected to joists or bearers. Bracing, designed by others, will be required subject to post design, spacing and relevant loads.

Connections

All connections used to tie the Stramit® Residential Floor Framing System to the rest of the structure should be capable of withstanding the required gravity, lateral, wind and all other applicable loads and actions.

Posts or piers supplied by others must comply with the NCC and relevant standards, and are connected to the floor system using conventional bolted connections.

Design limitations

The Stramit® C-Joist System is suitable for suspended floor framing in single occupancy buildings which come within the scope of a Class 1a dwelling as defined by the NCC. The building should conform to all limitations as set out in Clause 1.2 of AS 4055.

Floor live load exceeding 1.5kPa (2.0kPa for balconies) requires engineering calculations. Floor concentrated load of more than 1.8kN requires engineering calculations. It may not be suitable for heavy items such as water beds, water tanks, large plants or aquariums, heavy gym equipment or pianos. Please seek engineering advice for such applications. The system is also not suitable for applications closer than 1km to aggressive environments.

Connections between bearers and the structural elements of the building are the responsibility of the building designer. Stramit® C-Joists must be used between bearers, as an in-plane system. The use of the products in a joist on bearer configuration can lead to an undesirable transfer of movement-related vibration within and between rooms and is not recommended.

Design load criteria

The Stramit® Residential Floor Framing System uses the Limit State method. Minimum design load and load combinations are generally as per NASH Standard Part 1.

How to use the residential floor framing system tables

The following 4-step process explains how to use the suite of tables, developed to help you calculate the maximum span for a range of design variables.

1. Lay out the floor plan.

From the floor plan of the dwelling, determine the direction of the edge bearers. These generally run in the direction of the roof ridge. The spacing between the bearers is the joist span and this is limited to a maximum of about 6m. Add internal bearers as needed. Finally, break the floor area into 'ladders', consisting of bearers either side, with the joists in between like ladder rungs at 450mm centres.

2. Design the internal bearers and joist size.

Design the internal bearers (if present) by deciding upon the bearer span. Look up the table for main floor single spans (table 14.1), continuous spans (table 14.2) or balcony floor single spans (table 14.3) and continuous span bearers (table 14.4). Then determine the joist and internal bearer size and thickness from the joist span and bearer span combination. As a guide keep within the coloured bands on the table. Please note that there is no roof loading on internal bearers.

3. Design the external bearers.

Roof loads are carried down the walls and onto the external bearers. The Roof Load Width (RLW) must be calculated to determine this load, which will vary depending upon the roofing design, as shown in the diagram below.

$$RLW = (X/2) + OH.$$

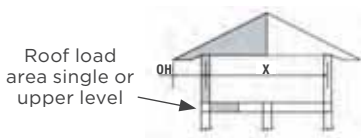

Tables 14.5 and 14.6 have the RLW, and bearer span type for buildings under metal roofs. Using the same joist and bearer spans

as above, determine the external bearer size for buildings with metal roofs. Alternatively, use tables 14.7 and 14.8 for buildings under tiled roofs. Next, ensure that the external bearer has the same depth as the joist and internal bearer selected in step 2. If not, then the larger of the depths needs to be selected.

4. Finalise the FCB3 bracket and screw design.

Using tables 14.5 to 14.8 for the selected external bearer detail, add the FCB3 brackets and the required fasteners to the bearers above all posts unless indicated in the table.

Please refer to chapter 17 for a worked example on how to use the residential floor framing system tables.

Summary Checklist

- ✓ Ensure the bearers are parallel to the roof ridge line
- ✓ Break the floor plan down into 'ladders' up to about 6m wide (joist span)
- ✓ Check that the bearers and joists have the same web depth
- ✓ Ensure the FCB3 brackets are attached to the bearer web above each post or pier when required
- ✓ Maximise bearer and joist spans to minimise the number of posts
- ✓ For more information go to stramit.com.au/products/

Residential Floor Framing System

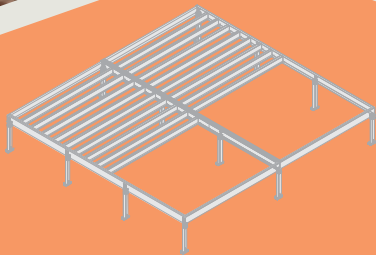

The Stramit® Residential Floor Framing System offers a tailored suspended floor design solution for single- or upper-storey houses.

- Combines Stramit® structural members with Steel-MAX™ brackets and accessories:
 - Stramit® C-Joists and Bearers
 - Stramit® C-Joist and Bearer connectors
 - Pre-cut bearers and joists
- Extended bearer options to provide larger span design opportunities
- Quick and easy to install

For the lower floor of two storey installations, please refer to the Stramit® Residential Floor Framing Technical manual.



AVAILABLE



NOT AVAILABLE



Fasteners

All screw fasteners must comply to Australian Standard AS3566, Class 2 – sheet flooring screws (internal use only), or Class 3 – connection screws.

Generally, any suitable 10- or 12-sized fasteners will connect the flooring components. Fasteners must not be positioned within 15mm of any metal edge.

All particle board (or other floor sheeting) fasteners should follow the recommendations of the board manufacturer. Stramit recommends gluing and screwing all sheet floors.

Flooring

Particle board or plywood structural sheet flooring in accordance with the NCC is used as the floor surface, although other sheet floor materials with similar properties (e.g. minimum modulus of elasticity $E=3\text{GPa}$) can be used.

Please refer to the floorboard manufacturer for details on sheet flooring, fasteners and adhesives that comply with NCC requirements for metal floor joist support systems.

Accessories

Apart from the range of joists and bearers, Stramit supplies simple brackets to connect and/or stiffen components. All posts, piers, other connectors and flooring sheets are supplied by others.

Performance

The performance of the metal floor system depends upon the following variables:

- Metal or tiled roof
- Main or balcony floor areas
- Joist and bearer span

The maximum span to suit the design variables can be determined from the following tables.

Table 14.1 Main floors - 1.5kPa loading
Internal bearers - single span
Joist sizing

No roof loading Joist spacing 450mm		Bearer span														
Bearer	Joist span	1.2	1.4	1.6	1.8	2.0	2.2	2.4	2.6	2.8	3.0	3.2	3.4	3.6	3.8	4.0
B11519	2.0	J11510	J11510	J11510	J11515	J18210	J18210	J18210	J18210	J18210	J23512	J23512	J23512	J28319	J28319	J28319
	2.4	J11512	J11515	J11519	J18210	J18210	J18210	J18210	J18212	J23512	J23512	J23512	J28319	J28319	J28319	J28319
	2.8	J11519	J18210	J18210	J18210	J18210	J18210	J18212	J18219	J23512	J23512	J23515	J28319	J28319	J28319	J28319
B18219	3.2	J18210	J18210	J18210	J18210	J18210	J18212	J18219	J23512	J23512	J23512	J23524	J28319	J28319	J28319	J28319
	3.6	J18212	J18212	J18212	J18215	J18215	J18219	J18224	J23512	J23512	J23512	J23515	J28319	J28319	J28319	J28319
	4.0	J18219	J18219	J18219	J18219	J18224	J23512	J23512	J23512	J23512	J23515	J23524	J28319	J28319	J28319	J28319
B23519	4.4	J18224	J18224	J18224	J23512	J23512	J23512	J23515	J23515	J23515	J23519	J28319	J28319	J28319	J28319	J28319
	4.8	J23515	J23515	J23515	J23515	J23515	J23519	J23519	J23519	J28319	J28319	J28319	J28319	J28319	J28319	J28319
	5.2	J23519	J23519	J23519	J23519	J23519	J23519	J23524	J28319	J28319	J28319	J28319	J28319	J28319	J28319	J28319
B28319	5.6	J23524	J23524	J23524	J23524	J28319	J28319	J28319	J28319	J28324	J28319	J28319	J28319	J28319	J28319	J28319
	6.0	J28319	J28319	J28319	J28324	J28324	J28324	J28324	J28324	J28324	J28324	J28324	J28324	J28324	J28324	J28324

24 mm BMT	2.0	J18210	J18210	J18210	J18210	J18210	J18210	J18210	J18210	J18210	J18210	J18210	J23512	J23512	J23512	J28319	J28319
	2.4	J18210	J18210	J18210	J18210	J18210	J18210	J18210	J18210	J18210	J18210	J18210	J23512	J23512	J23512	J28319	J28319
	2.8	J18210	J18210	J18210	J18210	J18210	J18210	J18210	J18210	J18210	J18210	J18210	J23512	J23512	J23512	J28319	J28319
	3.2	J18210	J18210	J18210	J18210	J18210	J18210	J18210	J18210	J18210	J18210	J18210	J23512	J23512	J23512	J28319	J28319
	3.6	J18212	J18212	J18212	J18215	J18215	J18215	J18215	J18215	J18215	J18215	J18215	J23512	J23512	J23515	J28319	J28319
	4.0	J18219	J18219	J18219	J18219	J18219	J18219	J18219	J18219	J18219	J18219	J18219	J23512	J23512	J23512	J28319	J28319
	4.4	J18224	J18224	J18224	J18224	J18224	J18224	J18224	J18224	J18224	J18224	J18224	J23512	J23512	J23512	J28319	J28319
	4.8	J23515	J23515	J23515	J23515	J23515	J23515	J23515	J23515	J23515	J23515	J23515	J23515	J23515	J23515	J28319	J28319
	5.2	J23519	J23519	J23519	J23519	J23519	J23519	J23519	J23519	J23519	J23519	J23519	J23519	J23519	J23519	J28319	J28324
	5.6	J23524	J23524	J23524	J23524	J23524	J23524	J23524	J23524	J23524	J23524	J23524	J23524	J23519	J23519	J28319	J28324
	6.0	J28319	J28319	J28319	J28319	J28319	J28319	J28319	J28319	J28319	J28319	J28319	J28319	J28319	J28319	J28319	J28319
		B28324	J28319	J28319	J28319	J28319	J28319	J28319	J28319	J28319	J28319	J28319	J28319	J28319	J28319	J28319	J28319
			J28319	J28319	J28319	J28319	J28319	J28319	J28319	J28319	J28319	J28319	J28319	J28319	J28319	J28319	J28319

All spans in metres.

Table 14.3 Balcony floors - 2.0kPa loading
Internal bearers - single span
Joist sizing

No roof loading Joist spacing 450mm		Bearer span														
Bearer	Joist span	1.2	1.4	1.6	1.8	2.0	2.2	2.4	2.6	2.8	3.0	3.2	3.4	3.6	3.8	4.0
B11519	2.0	J11510	J11512	J11515	J18210	J18210	J18210	J18210	J23512	J23512	J23512	J28319	J28319	J28319		
	2.4	J11519	J11519	J18210	J18210	J18210	J18210	J18215	J23512	J23512	J23512	J28319	J28319	J28319		
B18219	2.8	J18210	J18210	J18210	J18210	J18210	J18215	J18224	J23512	J23512	J23512	J28319	J28319			
	3.2	J18212	J18212	J18212	J18215	J18215	J18219	J23512	J23512	J23512	J28319	J28319	J28319			
	3.6	J18215	J18219	J18219	J18219	J18224	J23512	J23512	J23512	J23515	J23519	J28319	J28319			
	4.0	J18224	J18224	J18224	J23512	J23512	J23512	J23515	J23515	J23519	J28319	J28319	J28319			
B23519	4.4	J23515	J23515	J23515	J23515	J23515	J23519	J23519	J28319	J28319	J28319	J28319				
	4.8	J23519	J23519	J23519	J23519	J23519	J23524	J28319	J28319	J28319	J28319	J28319				
	5.2	J23524	J23524	J23524	J23524	J28319	J28319	J28319	J28319	J28319	J28319	J28319				
B28319	5.6	J28319	J28319	J28319	J28319	J28324	J28324	J28324	J28324	J28324	J28324	J28324				

Table 14.4 Balcony floors - 2.0kPa loading
Internal bearers - continuous span
Joist sizing

No roof loading Joist spacing 450mm		Bearer span														
Bearer	Joist span	1.2	1.4	1.6	1.8	2.0	2.2	2.4	2.6	2.8	3.0	3.2	3.4	3.6	3.8	4.0
B11519	2.0	J11510	J11510	J11510	J11512	J11519	J18210	J18210	J18210	J18210	J18210	J23512	J23512	J23512	J28319	J28319
	2.4	J11515	J11519	J11519	J18210	J18210	J18210	J18210	J18210	J18212	J23512	J23512	J23512	J28319	J28319	J28319
B18219	2.8	J18210	J18210	J18210	J18210	J18210	J18210	J18210	J18215	J23512	J23512	J23512	J28319	J28319	J28319	J28319
	3.2	J18210	J18212	J18212	J18212	J18212	J18215	J18219	J23512	J23512	J23512	J28319	J28319	J28319	J28319	J28319
B23519	3.6	J18215	J18215	J18215	J18219	J18219	J18219	J18224	J23512	J23512	J23512	J28319	J28319	J28319	J28319	J28319
	4.0	J18224	J18224	J18224	J18224	J18224	J23512	J23512	J23515	J28319	J28319	J28319	J28319	J28319	J28319	J28319
B28319	4.4	J23515	J23515	J23515	J23515	J23515	J23515	J23519	J28319	J28319	J28319	J28319	J28319	J28319	J28319	J28319
	4.8	J23519	J23519	J23519	J23519	J23519	J23519	J23524	J28319	J28319	J28319	J28319	J28319	J28319	J28319	J28319
B28319	5.2	J23524	J23524	J23524	J23524	J23524	J23524	J28319	J28319	J28319	J28319	J28319	J28319	J28319	J28319	J28319
	5.6	J28319	J28319	J28319	J28319	J28319	J28319	J28324	J28319	J28319	J28319	J28319	J28319	J28319	J28319	J28319
	6.0	J28324	J28324	J28324	J28324	J28324	J28319	J28324	J28319	J28324	J28319	J28319	J28319	J28319	J28319	J28319

1.9 mm BMT

Table 14.5 Main floors - 1.5kPa loading
External bearers - single span
Roof load with metal roof loading

Joist spacing 450mm		All post supports require FCB3 with 4 fasteners (unless marked)															
RLW (m)	Joist span	Bearer span											4.0				
		1.2	1.4	1.6	1.8	2.0	2.2	2.4	2.6	2.8	3.0	3.2		3.4	3.6	3.8	
2	2.0	B11519	B11519	B11519	B11519	B18219	B18219	B18219	B18219	B18219	B18219	B18219	B18224	B23519	B23519	B23524	B28319
	2.4	B11519	B11519	B11519	B18219	B18219	B18219	B18219	B18219	B18219	B18224	B23519	B23519	B23519	B23519	B23524	B28324
	2.8	B11519	B11519	B11519	B18219	B18219	B18219	B18219	B18219	B18219	B18224	B23519	B23519	B23519	B23519	B23524	B28324
	3.2	B18219	B18219	B18219	B18219	B18219	B18219	B18219	B18219	B18224	B23519	B23519	B23519	B23519	B23519	B23524	B28324
	3.6	B18219	B18219	B18219	B18219	B18219	B18219	B18219	B18219	B18224	B23519	B23519	B23519	B23519	B23519	B23524	B28324
	4.0	B18219	B18219	B18219	B18219	B18219	B18219	B18219	B18219	B18224	B23519	B23519	B23519	B23519	B23519	B23524	B28324
	2.0	B11519	B11519	B11519	B18219	B18219	B18219	B18219	B18219	B18219	B18224	B23519	B23519	B23519	B23519	B23524	B28324
	2.4	B11519	B11519	B11519	B18219	B18219	B18219	B18219	B18219	B18219	B18224	B23519	B23519	B23519	B23519	B23524	B28324
	2.8	B11519	B11519	B11519	B18219	B18219	B18219	B18219	B18219	B18219	B18224	B23519	B23519	B23519	B23519	B23524	B28324
	3.2	B18219	B18219	B18219	B18219	B18219	B18219	B18219	B18219	B18224	B23519	B23519	B23519	B23519	B23519	B23524	B28324
3.6	B18219	B18219	B18219	B18219	B18219	B18219	B18219	B18219	B18224	B23519	B23519	B23519	B23519	B23519	B23524	B28324	
4.0	B18219	B18219	B18219	B18219	B18219	B18219	B18219	B18219	B18224	B23519	B23519	B23519	B23519	B23519	B23524	B28324	
4.4	B18219	B18219	B18219	B18219	B18219	B18219	B18219	B18219	B18224	B23519	B23519	B23519	B23519	B23519	B23524	B28324	
4.8	B23519	B23519	B23519	B23519	B23519	B23519	B23519	B23519	B23519	B23524	B23524	B23524	B23524	B23524	B23524	B28324	
5.2	B23519	B23519	B23519	B23519	B23519	B23519	B23519	B23519	B23519	B23524	B23524	B23524	B23524	B23524	B23524	B28324	

Table 14.6 Main floors - 1.5kPa loading
External bearers - continuous span
Roof load with metal roof loading

RLW (m)	Joist span	Bearer span																
		1.2	1.4	1.6	1.8	2.0	2.2	2.4	2.6	2.8	3.0	3.2	3.4	3.6	3.8	4.0		
2	2.0	B11519	B11519	B11519	B11519	B11519	B11519	B18219	B18219	B18219	B18219	B18219	B18219	B18219	B18219	B18219	B23519	B23519
	2.4	B11519	B11519	B11519	B11519	B11519	B11519	B18219	B18219	B18219	B18219	B18219	B18219	B18219	B18219	B18219	B23519	B23519
	2.8	B11519	B11519	B11519	B11519	B11519	B18219	B18219	B18219	B18219	B18219	B18219	B18219	B18219	B18219	B18219	B23519	B23519
	3.2	B18219	B18219	B18219	B18219	B18219	B18219	B18219	B18219	B18219	B18219	B18219	B18219	B18219	B18219	B18219	B23519	B23519
	3.6	B18219	B18219	B18219	B18219	B18219	B18219	B18219	B18219	B18219	B18219	B18219	B18219	B18219	B18219	B18219	B23519	B23519
	4.0	B18219	B18219	B18219	B18219	B18219	B18219	B18219	B18219	B18219	B18219	B18219	B18219	B18219	B18219	B18219	B23519	B23519
	2.0	B11519	B11519	B11519	B11519	B11519	B18219	B18219	B18219	B18219	B18219	B18219	B18219	B18219	B18219	B18219	B23519	B23519
	2.4	B11519	B11519	B11519	B11519	B11519	B18219	B18219	B18219	B18219	B18219	B18219	B18219	B18219	B18219	B18219	B23519	B23519
5	2.8	B11519	B11519	B11519	B11519	B18219	B18219	B18219	B18219	B18219	B18219	B18219	B18219	B18219	B18219	B18219	B23519	B23519
	3.2	B18219	B18219	B18219	B18219	B18219	B18219	B18219	B18219	B18219	B18219	B18219	B18219	B18219	B18219	B18219	B23519	B23519
	3.6	B18219	B18219	B18219	B18219	B18219	B18219	B18219	B18219	B18219	B18219	B18219	B18219	B18219	B18219	B18219	B23519	B23519
	4.0	B18219	B18219	B18219	B18219	B18219	B18219	B18219	B18219	B18219	B18219	B18219	B18219	B18219	B18219	B18219	B23519	B23519
	4.4	B18219	B18219	B18219	B18219	B18219	B18219	B18219	B18219	B18219	B18219	B18219	B18219	B18219	B18219	B18219	B23519	B23519
	4.8	B23519	B23519	B23519	B23519	B23519	B23519	B23519	B23519	B23519	B23519	B23519	B23519	B23519	B23519	B23519	B23519	B23519
	5.2	B23519	B23519	B23519	B23519	B23519	B23519	B23519	B23519	B23519	B23519	B23519	B23519	B23519	B23519	B23519	B23519	B23519

Joist spacing 450mm

All post supports require FCB3 with 4 fasteners (unless marked)

Table 14.7 Main floors - 1.5kPa loading
External bearers - single span
Roof load with tile roof loading

RLW (m)	Joist span	Bearer span															
		1.2	1.4	1.6	1.8	2.0	2.2	2.4	2.6	2.8	3.0	3.2	3.4	3.6	3.8	4.0	
2	2.0	B11519	B11519	B11519	B18219	B18219	B18219	B18219	B18224	B18224	B18224	B23519	B23519	B23524	B28324	B28324	
	2.4	B11519	B11519	B11519	B18219	B18219	B18219	B18219	B18224	B18224	B23519	B23519	B23519	B23524	B28324	B28324	B28324
	2.8	B11519	B11519	B11519	B18219	B18219	B18219	B18219	B18224	B18224	B23519	B23519	B23519	B23524	B28324	B28324	B28324
	3.2	B18219	B18219	B18219	B18219	B18219	B18219	B18219	B18224	B23519	B23519	B23519	B23524	B28324	B28324	B28324	B28324
	3.6	B18219	B18219	B18219	B18219	B18219	B18219	B18219	B18224	B23519	B23519	B23519	B23524	B28324	B28324	B28324	B28324
	4.0	B18219	B18219	B18219	B18219	B18219	B18219	B18219	B18224	B23519	B23519	B23519	B23524	B28324	B28324	B28324	B28324
	2.0	B11519	B11519	B18219	B18219	B18219	B18219	B18219	B18224	B23519	B23519	B23519	B23524	B28324	B28324	B28324	B28324
	2.4	B11519	B11519	B18219	B18219	B18219	B18219	B18219	B18224	B23519	B23519	B23519	B23524	B28324	B28324	B28324	B28324
5	2.8	B11519	B11519	B18219	B18219	B18219	B18219	B18219	B18224	B23519	B23519	B23519	B23524	B28324	B28324	B28324	B28324
	3.2	B18219	B18219	B18219	B18219	B18219	B18219	B18219	B18224	B23519	B23519	B23519	B23524	B28324	B28324	B28324	B28324
	3.6	B18219	B18219	B18219	B18219	B18219	B18219	B18219	B18224	B23519	B23519	B23519	B23524	B28324	B28324	B28324	B28324
	4.0	B18219	B18219	B18219	B18219	B18219	B18219	B18219	B18224	B23519	B23519	B23519	B23524	B28324	B28324	B28324	B28324
	4.4	B18219	B18219	B18219	B18219	B18219	B18219	B18219	B18224	B23519	B23519	B23519	B23524	B28324	B28324	B28324	B28324
	4.8	B23519	B23519	B23519	B23519	B23519	B23519	B23519	B23524	B23524	B23524	B23524	B23524	B28324	B28324	B28324	B28324
	5.2	B23519	B23519	B23519	B23519	B23519	B23519	B23519	B23524	B23524	B23524	B23524	B23524	B28324	B28324	B28324	B28324

Joist spacing 450mm

All post supports require FCB3 with 4 fasteners (unless marked)

Table 14.8 Main floors - 1.5kPa loading
External bearers - continuous span
Roof load with tile roof loading

RLW (m)	Joist span	Bearer span																		
		1.2	1.4	1.6	1.8	2.0	2.2	2.4	2.6	2.8	3.0	3.2	3.4	3.6	3.8	4.0				
2	2.0	B11519	B11519	B11519	B11519	B11519	B18219	B18219	B18219	B18219	B18219	B18219	B18219	B18219	B18219	B18219	B23519	B23519		
	2.4	B11519	B11519	B11519	B11519	B11519	B18219	B18219	B18219	B18219	B18219	B18219	B18219	B18219	B18219	B18219	B23519	B23524	B23524	
	2.8	B11519	B11519	B11519	B11519	B11519	B18219	B18219	B18219	B18219	B18219	B18219	B18219	B18219	B18219	B18219	B23519	B23524	B23524	B23524
	3.2	B18219	B18219	B18219	B18219	B18219	B18219	B18219	B18219	B18219	B18219	B18219	B18219	B18219	B18219	B18219	B23524	B23524	B23524	B23524
	3.6	B18219	B18219	B18219	B18219	B18219	B18219	B18219	B18219	B18219	B18219	B18219	B18219	B18219	B18219	B18219	B23524	B23524	B23524	B23524
	4.0	B18219	B18219	B18219	B18219	B18219	B18219	B18219	B18219	B18219	B18219	B18219	B18219	B18219	B18219	B18219	B23524	B23524	B23524	B23524
	2.0	B11519	B11519	B11519	B11519	B18219	B18219	B18219	B18219	B18219	B18219	B18219	B18219	B18219	B18219	B18219	B23524	B23524	B23524	B23524
	2.4	B11519	B11519	B11519	B18219	B18219	B18219	B18219	B18219	B18219	B18219	B18219	B18219	B18219	B18219	B18219	B23524	B23524	B23524	B23524
	2.8	B11519	B11519	B11519	B18219	B18219	B18219	B18219	B18219	B18219	B18219	B18219	B18219	B18219	B18219	B18219	B23524	B23524	B23524	B23524
	3.2	B18219	B18219	B18219	B18219	B18219	B18219	B18219	B18219	B18219	B18219	B18219	B18219	B18219	B18219	B18219	B23524	B23524	B23524	B23524
3.6	B18219	B18219	B18219	B18219	B18219	B18219	B18219	B18219	B18219	B18219	B18219	B18219	B18219	B18219	B18219	B23524	B23524	B23524	B23524	
4.0	B18219	B18219	B18219	B18219	B18219	B18219	B18219	B18219	B18219	B18219	B18219	B18219	B18219	B18219	B18219	B23524	B23524	B23524	B23524	
4.4	B18219	B18219	B18219	B18219	B18219	B18219	B18219	B18219	B18219	B18219	B18219	B18219	B18219	B18219	B18219	B23524	B23524	B23524	B23524	
4.8	B23519	B23519	B23519	B23519	B23519	B23519	B23519	B23519	B23519	B23519	B23519	B23519	B23519	B23519	B23519	B23519	B23519	B23519	B23519	
5.2	B23519	B23519	B23519	B23519	B23519	B23519	B23519	B23519	B23519	B23519	B23519	B23519	B23519	B23519	B23519	B23519	B23519	B23519	B23519	

Joist spacing 450mm

All post supports require FCB3 with 4 fasteners (unless marked)



15. Roller Doors

Quality, Australian
made doors and
shutters

A WHOLLY OWNED SUBSIDIARY OF STRAMIT, TAUREAN® DOOR SYSTEMS IS THE PARTNER OF CHOICE FOR DOOR RESELLERS, SHED MANUFACTURERS AND SELF-STORAGE FACILITY BUILDERS WHO WANT TO GROW THEIR BUSINESS

We manufacture a range of quality garage door and commercial roller shutter solutions to suit your every project need from roller, sectional and automatic doors for domestic applications through to shutter and automation products for industrial and warehouse projects.

Stramit took over Creeks Metal Industries in 2001, and with more than 60 years' experience built on the proven performance of Creeks' Industries, our customers remain confident of never getting caught short of a product or service.

Openers

Taurean® Door Systems recommends and supplies the Merlin and Grifco range of door openers to suit our doors.

TauraEdge® safety tracks

The TauraEdge® Roller Door Track is the first of its type in Australia, with a rolled over design replacing the standard edge. The sides are completely encased — simple but effective.

Stronger and more rigid than standard roller door tracks, the TauraEdge® Roller Door Track is all about safety, design improvements and efficiency.

Warranty

The 12-month product warranty covers domestic installations only and is for steel cracking, lock seam failure of the door curtain and all other door items.

Excluded from the warranty is salt corrosion or any damage to the door curtain from any environmental conditions or issues.

How to use the roller door tables

Only roller doors listed in the tables below have wind ratings.

1. For applications requiring a wind rated roller door, select a wind pressure category from AS 4505.
2. Ensure the door size limits are not exceeded.
3. If windlocks are used to increase the door resistance to wind loads then care must be taken to allow for the door abutment forces that must be carried by the structure around the door.

The door curtain will go into tension under the wind load, and create a horizontal force on each side of the door structure (F_x).

4. These forces are shown in the following diagram and explanation.



F_y is the out-of-plane force perpendicular to the plane of the door, and can be in either direction depending on the wind direction.

F_x is the force parallel to the plane of the door. The direction of this force is towards the centre of the opening.

5. Forces given in tables 15.3 to 15.7 are in kN/m of door height.

Summary Checklist

- ✔ Select the door best suited to the application
- ✔ Ensure the size limits do not exceed the limitations set by the wind loads
- ✔ When using non-cyclonic wind rated doors with windlocks, or the cyclonic Windstrong® door range, design the surrounding structure to carry the resultant abutment forces
- ✔ When in doubt, ask your local Stramit or Taurean® Door Systems office for assistance
- ✔ For more information go to taureands.com.au

NovaTaur[®] Roller Door



The deep profile of this residential roller door offers unsurpassed strength and rigidity without compromising style.

- Deep rounded profile, providing strength and rigidity with a heavy duty bottom rail on the curtain
- TauraEdge[®] galvanised safety tracks/guides ensure ultimate safety
- A rolling wheel added to each end of the bottom rail ensures smooth operation, and the flexible sealing strip completes the stylish door
- Door is balanced with customised springing (25,000 cycles), galvanised tracks and steel drum wheels ensuring optimum door life
- Available in two thicknesses for either residential or commercial applications



AVAILABLE



NOT AVAILABLE



Size options

Available to suit door openings 2500mm high and up to 6000mm wide. Novataur® residential doors are limited to 2500mm high, while the commercial door is limited to 5100mm high.

Accessories

For tracks, locking bars, locks, openers, operators and operator accessories for your Taurean Door, please refer to the Stramit® *Product and Service Guide* for your area.

Performance

For non-windlocked doors the NovaTaur® roller door has exceptional performance.

The NovaTaur® commercial door has the following wind load limitations.

Table 15.1 NovaTaur® commercial roller door

Wind classification	Maximum door width (mm)
N1	3750
N2	3090
N3	NA

Non windlocked
Guide track - B tracks
Wind categories to AS 4505

The Pr1me Collection



Look no further than the Pr1me collection for quality design and value backed by decades of testing.

- Full range of opening sizes up to 5100mm high and 5400mm wide to suit single or double car garages for homes, sheds and buildings
- For windy regions, doors have the option of protection from potential blow-in by opting for the windlock system
- Door is balanced with customised springing (25,000 cycles) and galvanised tracks, ensuring optimum door life
- Compatible with the TauraEdge® safety guide system for added safety



AVAILABLE



NOT AVAILABLE



Size options

A Series Standard roller doors

A Series available to suit door opening heights between 1200-3100mm and widths from 750-3430mm.

AA Series Standard roller doors

AA Series available to suit door opening heights between 1200-3100mm and widths from 3431-5400mm.

B Series Standard roller doors

B Series available to suit door opening heights between 2200-5100mm and widths from 750-5100mm.

Accessories

For tracks, locking bars, locks, mullions and openers, tapered bottom rails, operators and operator accessories for your Taurean® Door, please refer to the Stramit® *Product and Service Guide* for your area.

Reverse roller doors also available for when there is insufficient internal head room available.

Tapered bottom rails and reverse roller doors are not available on windlocked or Windstrong® doors.

Performance

To reach the required performance standards Pr1me series doors need to be fitted with windlocks. In the table below, select the wind load classification from AS 4505 to suit the project, and read off the maximum door width and the required number of clips needed per side for installation.

Table 15.2 Pr1me Series roller door windlock configuration

Wind classification	Maximum door width (mm)	Clips/m
N1	5100	2.2
N2	5015	2.2
	5100	3.7
N3	3650	2.2
	5015	3.9
	5100	4.1
N4-N6	5100	Windstrong® doors

Guide track - windlock tracks

One track bracket per clip

Clips/m of door height

Wind categories to AS 4505

The Pr1me Series windlock roller door has a system of tracks and clips that put the door curtain into tension when withstanding extreme wind loads. The corresponding abutment forces exerted by the door on each side of the supporting structure are given in table 15.3 in kN/m of height.

Table 15.3 Pr1me series windlock roller door abutment forces (kN/m)

Wind classification N3	Maximum door width (mm)		
	0-3650	3651-5015	5016-5100
Fy inwards	5.5	6.2	8.2
Fx inwards	17.7	22.7	29.4
Fy outwards	9.5	9.5	11.2
Fx outwards	26.3	30.7	40.7

Forces in kN/m door height

Notes:

Windstrong® Roller Doors



This Windlocked roller door is built to stand up to extreme weather events without compromising performance or style.

- Suitable for use in Regions C and D and complies with AS/NZ 4505
- Classified for use as a Domestic door in Class 1 and 10 buildings to 20,000 cycles and as a General Purpose - Medium Cycle door in Class 1 to 10 buildings to 20,000 cycles



AVAILABLE



NOT AVAILABLE



Accessories

For tracks, locking bars, locks, openers, operators and operator accessories for your Taurean® Door, please refer to the Stramit® *Product and Service Guide* for your area.

Performance

For domestic doors, using a wind classification from AS 4505, determine the maximum door width and the matching abutment force from Table 15.4. This force is given in KN/m of door height and acts inwards towards the centre and in the plane of the door.

Table 15.4 Windstrong® doors - maximum door width

Domestic doors

Wind classification	Ultimate design wind pressure (kPa)		Maximum door width (mm)	Abutment force Fx (kN/m)
	Inward	Outward		
C1	1.96	2.04	5400	28
C2	2.92	3.04	5050	32.8
C3	4.30	4.95	3660	34.4
C4	5.81	6.69	2770	34.1

Forces in kN/m door height

For other domestic door widths refer to table 15.5.

Table 15.5 Windstrong® doors - maximum catenary force Fx

Domestic doors

Door width (mm)	Maximum catenary force Fx (kN/m) for wind load category			
	C1	C2	C3	C4
2500	15.5	20.4	26.6	32.2
3000	17.0	22.8	29.8	
3500	19.0	25.4	33.3	
4000	20.6	27.5		
4500	22.6	29.6		
5000	25.6	32.5		

Wind categories to AS 4505

Forces in kN/m door height

General purpose door widths, design pressures and abutment forces are found in tables 15.6 and 15.7.

Table 15.6 Windstrong® doors - maximum ultimate wind pressure

General purpose doors

Door width (mm)	Maximum design wind pressure (kPa)		Maximum ultimate forces on door frame (kN/m) Fx
	Inward	Outward	
2550	6.27	7.24	33.8
2800	5.76	6.91	34.9
3100	5.20	6.50	36.2
3430	4.64	6.02	37.1
3750	4.17	5.54	37.7
4350	3.46	4.59	37.0
5100	2.89	3.31	33.6
5400	2.76	2.77	33.9

Forces in kN/m door height

Table 15.7 Windstrong® doors - maximum catenary force Fx

General purpose doors

Ultimate pressure (kPa)	Maximum catenary force Fx (kN/m) for door frame width (mm)							
	2550	2800	3100	3430	3750	4350	5100	5400
2.0	14.3	15.3	16.4	17.7	18.9	22.1	26.6	28.3
2.4	16.4	17.5	18.8	20.3	21.8	25.2	29.7	31.5
2.8	18.3	20.0	21.2	22.9	24.5	28.0	32.4	
3.2	20.3	21.6	23.4	25.3	27.2	30.5		
3.6	21.9	23.5	25.5	27.6	29.7			
4.0	23.5	25.3	27.5	29.8	32.1			
4.4	25.1	27.0	29.3	31.9				
4.8	26.5	28.6	31.1					
5.2	27.8	30.1	32.8					
5.6	29.0	31.4						
6.0	30.2							

Forces in kN/m door height

Notes:

Secura-T Roller Shutters



This range of Secura-T roller shutters combines traditional design with durability – even for the harshest of conditions.

- Medium, general purpose and heavy duty models
- Wide range of slat types, including standard, slotted (11% ventilation) and perforated (40% ventilation)
- Full range of opening sizes up to 12,000mm high and up to 12,000mm wide to suit large and small industrial facilities
- Springing system custom engineered for each shutter with up to 35,000 cycles
- Standard locking by a guide-mounted, lockable chain clip
- Smooth and quiet running due to nylon end clips on slats
- Low maintenance, with no grease required



AVAILABLE



NOT AVAILABLE



Bottom rails

Heavy-duty extruded aluminium or box section steel bottom rails are available in three profiles to suit different applications.

Size options

Available to suit door opening heights between 2000-6000mm and widths from 1500-7000mm.

Windlock end clips and guides

For areas subject to high wind conditions, or for very wide openings, 75mm or 100mm shutters should be fitted with malleable iron windlock end clips and steel windlock guides. Windlock clips prevent the curtain disengaging from the guides under wind pressure.

Accessories

For tracks, locking bars, locks, mullions and openers, operators and operator accessories for your Taurean® Door, please refer to the Stramit® *Product and Service Guide* for your area.

Classic Sectional Door



Offering four styles in single or double garage doors up to 3m high, the Classic range of sectional doors enhance your home front.

- In four classic appearance styles
- Finger safe panel joins
- Super quiet using hinge inserts and nylon curves to reduce noise
- More rigid 0.60mm steel panels ensure maximum strength
- Long life using proven components for exceptional performance



AVAILABLE



NOT AVAILABLE



Bottom rails

Co-extruded in black to enhance the door appearance.

Style options

Linea:

A stylish, contemporary sectional door formed with thin lines to give a relaxed, angled look.

Tempo:

A symmetrical looking sectional door with a square press pattern designed to enhance the look of any home.

Western:

A traditional interpretation of a real classic with a powerful, rectangular press pattern giving a strong feel to the door.

Silk:

The new modern with a casual feel created from the flush appearance.

Accessories

For tracks, openers, operators and operator accessories for your Taurean® Door, please refer to the Stramit® *Product and Service Guide* for your area.

The recommended optional opener is a Mach1.



16. Sheds

Flexible shed
solutions

CUT TO LENGTH AND MADE TO ORDER, WE SUPPLY QUALITY STEEL BUILDING MATERIALS FOR EVERY SHED IMAGINABLE, INCLUDING THOSE TRANSFORMED INTO HABITABLE SPACES

Our products are available in a range of materials and colours, giving you choice and options that will withstand Australia's range of environmental conditions.

Guaranteed quality and performance

Whether you buy shed components such as purlins and structural, roofing and walling, rainwater products or roller and sectional doors, you can be confident they have been tried and tested to Australian standards.

Technical data and guidelines for all our steel products are available so sheds can be independently designed and engineered.

Our technical services consultants are also on hand to answer questions and help with product selection and after-sales support.



17. Worked example

THE FOLLOWING WORKED EXAMPLE DEMONSTRATES HOW *THE STRAMIT BOOK OF ANSWERS*[®] HELPS DEVELOP TOTAL STEEL BUILDING PRODUCT SOLUTIONS QUICKLY AND EFFICIENTLY

It is not intended to replace engineering design, and all calculations and results should be confirmed with engineering advice. All tables are based on AS 4055 which is intended for domestic sized structures only.

For more information visit the Stramit website at stramit.com.au for access to the full product technical manuals and load tables. Alternatively, contact your local Stramit office or your local technical services team member for more detail.

ABC Engineering Pty Ltd is designing a domestic house and garage in an inland Brisbane suburb.

1. Materials selection

(Refer to chapter 4)

Specify:

- Galvanised structural sections
- COLORBOND® steel roofing and walling (profile yet to be selected)
- Galvanised screws
- COLORBOND® steel rainwater products, after confirming the suitability of the combination of materials by referring to compatibility tables 4.2, 4.3 and 4.4

2. Wind load category

(Refer to chapter 5)

Determine the required wind load classification.

- a) Brisbane is in Region B
- b) The structure is well within the suburb so Terrain Category 3 applies
- c) The structure is within the lower third of a hill so the topography classification is TO
- d) Full shielding applies
- e) The house will have a wind classification of N2 determined by table 5.4

3. Roof design

(Refer to chapters 7, 8 and 18)

The house's size details are as follows:

- The structure is 12m x 8m x 4m high in size
- Roof pitch is proposed at 15 degrees, with an eave overhang of 600mm on each side

a) Determine roof run length

- Use table 18.7 in the Helpful Information section to determine roof run length required for a 15-degree roof pitch
- The overall house plan width = $8 + (2 \times 0.6) = 9.2\text{m}$
Half width is 4.6m
For a 15-degree roof pitch, roof run length will be 4.76m

b) Check for thermal expansion

- Use table 7.1 in the Thermal Expansion section in the Roofing general section

- For through fixed sheets and a flat (straight run) sheet this project is well within the thermal length limits

c) Check for roof drainage

- Use table 7.2 for Queensland in the general section for roofing, under Roof Slope Drainage
- All Stramit® roof claddings are suitable for this project

d) Check for spring curve limits

- This does not apply for this project, however refer to the general area for Roofing under spring curving for limitations for curved cladding on page 52

e) Select a roof profile

- Options include Corrugated or Monoclad® profiles
- Consider the thickness of the steel battens to be used as these have a significant effect on the cladding performance
- Stramit® domestic 40mm roof batten uses a 0.55mm base in the Brisbane region

Option 1. Corrugated cladding - 0.42mm BMT cladding material

Corrugated cladding

Use Corrugated tables in chapter 7 (using 3 fasteners per sheet).

- The maximum internal/end spans would be for N2, 1300/900mm
- Refer to How to use the cladding tables section in chapter 7 to calculate the actual spans
- As the roof run length is 4.76m, the calculated reduced end span combination will be 1030/830
- This roof solution requires 6 battens
- An equal span solution would be spans at a maximum of 900mm centres
- The calculated equal span then is 790mm
- This roof solution requires 7 battens
- As highlighted in chapter 5, consideration needs to be made for the higher loads in corner areas. Either add extra battens 1.2m long in the corner areas at the middle of the end span, or alternatively if possible add additional fasteners to the cladding, and check against a high wind load category
- The option to use N3 check for corner pressures does work as the allowable spans are higher than actual
- No additional battens are required in corner areas

Note: Corner areas are measured in both directions. Where small spans are used, then additional mid-point battens may be required in intermediate spans up to 1.2m from the corner.

Option 2. Corrugated cladding - 0.48mm BMT material

- The maximum internal/end spans would be for N2, 1700/1350mm
- As roof run length is 4.76m, the calculated reduced end span combination will be 1320/1060
- This roof solution requires 5 battens
- An equal span solution would be spans at a maximum of 1400mm centres
- The calculated equal span then is 1190mm
- This roof solution requires 5 battens
- As highlighted in chapter 5, consideration needs to be made for the higher loads in corner areas
- The option to use N3 check for corner pressures doesn't work as the allowable spans are too low
- Either add an intermediate batten in the middle of each end span for 1.2m along the roof from the corners or, for the internal/end span combination, add one batten row, reducing the spans to 1030/830
- This result uses 6 battens
- The equal span case needs an additional batten to give spans of 950mm
- This result uses 6 battens

Note: The use of 5 fasteners per sheet will carry the extra wind load, so a better option would be to fix the cladding with 5 fasteners per sheet in the corner areas, saving all the additional battens.

Monoclad® cladding

Use Monoclad® tables in chapter 7 (using 4 fasteners per sheet) using the 40mm 0.55 BMT roof batten as above.

Option 3. Monoclad® cladding - 0.42mm BMT material

- The maximum internal/end spans would be for N2, 2000/1600mm
- Refer to How to use the cladding tables section in chapter 7 to calculate the actual spans
- As roof run length is 4.76m, the calculated reduced end span combination will be 1830/1460
- This roof solution requires 4 battens
- An equal span solution would be spans at a maximum of 1600mm centres
- The calculated equal span then is 1580mm
- This roof solution requires 4 battens
- As highlighted in chapter 5, consideration needs to be made for the higher loads in corner areas

- The option to use N3 check for corner pressures doesn't work as the allowable spans are too low
- Either add an intermediate batten in the middle of each end span for 1.2m along the roof from the corners or, for the internal/end span combination, add one batten row, reducing the spans to 1300/1060
- This result uses 5 battens
- The equal span case needs an additional one batten to give spans of 1190mm
- This result uses 5 battens

f) Roof determination

These results could also be adjusted by using thicker battens or top hats. However, from the above design evaluation, the options are:

Roof Materials	Thickness	Number of battens		Comments
		Int/End	Equal	
Corrugated	0.42	6	7	Standard installation
	0.48	5	5	Requires 5 fasteners per sheet in corners
Monoclad	0.42	4	4	Requires additional mid-point batten for 1.2m in corner areas

- The final selection is at the designer's discretion. Both 0.42mm solutions require approximately the same number of fasteners, but Monoclad® requires slightly less battens
- For example purposes, we will select Monoclad® 0.42mm BMT using a reduced end span system with internal span of 1830, and end spans of 1460mm
- Add additional battens, 1.2m in length, at midspan of the end spans at all corners
- The Monoclad® tables give us the fastener as a M6 x 65 hex head Zip screw used at every rib

A garage is also being built alongside the house and will use Monoclad® roofing and suitable cladding to complement the house.

The roof plan area is 6m x 6m; the roof run plan dimension is 3m; and using table 18.2, the roof run length is 3100mm.

- Roof is 0.42mm Monoclad®; assume a top hat thickness of 1.00mm
- Use the Equal span table and Monoclad® table 7.26 to establish the maximum span of 1600mm
- The actual span is 1550mm; fasteners are M6 x 65 hex head Zip screws

4. Roof batten design

(Refer to chapter 12)

- When designing the roof sheeting a 0.55mm batten was used
- This needs to be designed to ensure that it can support the roof sheet
- Check what supports are under the roof batten. In this case we have timber trusses at 600mm centres
- Table 12.1 gives the maximum spacing of the batten
- For a 600mm span, using the 0.55mm batten in a N2 condition, the maximum batten spacing is 2250mm
- The Monoclad® spans are OK
- The fasteners required to attach the batten to the trusses are 2 x 12 Type 17 screws with at least 25mm of engagement

The garage alongside the house is using top hats to support the roof.

(Refer to chapter 11)

- The garage portal frames are at 3m centres, and a double span top hat is required to span over them
- The top hats options include TH64100 at 900mm centres (table 11.1), or TH96100 at 1600 centres (table 11.2)
- The connection details shown in tables 11.5 to 11.8 use a support thickness of 1.5mm, and give spacings of between 500mm and 750mm depending on the size and number of fasteners
- However, a better solution is to change to single span top hats, using a 100mm non-structural overlap and double the fastener requirement at the central support
- The TH64100 top hats can now be spaced at 800mm, and the TH96100 at 1100mm, or alternatively the lighter TH64120 could be spaced at 1050mm

- The fastener options are now:
 - 2x12 (table 11.5) gives 1250mm spacing
 - 4x12 (table 11.6) gives 1650mm spacing
 - 2x14 (table 11.7) gives 1500mm spacing
 - 4x14 (table 11.8) gives 1750mm spacing
- These higher values can be used in the design
- The simple single span solution using TH64120 at 1000mm centres using 2x12 hex head SD screws (also giving the 1000mm spacing result) to connect to the portal gives a good result
- Re-checking the roof sheeting, Monoclad® sheeting is OK at 1000mm equal spans

Note I: The roof run length is 3100mm. However, we can utilise the overhang capability of the Monoclad® roof sheet (up to a maximum of 150mm per end, refer to table 7.21 maximum overhang to allow the use of the three 1000mm roof spans.

5. Wall cladding design

(Refer to chapter 7)

- The house has a timber frame with studs at 600mm centres
- Under Architectural wall claddings, table 7.131 provides the spanning capacity of one of the available wall profiles
- Using C-Clad 280, the wall spans can be up to 1900mm
- To ensure the cladding is firmly attached to the studs, fix at every stud
- Performance is adequate, and also complies with the recommended span to cater for human impact given on page 52
- The table gives the fastener as 10x25mm wafer head Type 17 screws used at every stud

For the garage walls:

- The same TH64120 top hats can be used on the garage walls
- Wall girt maximum spacing will be 1050mm
- Under K-Panel®, table 7.100 gives the wall cladding performance
- 0.35mm K-Panel® will span 1350mm in equal spans so OK

6. Rainwater solution

(Refer to chapter 9)

- Because the house is traditional in design, it will require a Quad gutter or a profile similar in appearance
- Check the gutter drainage and select a gutter that suits from table 9.2
- In Brisbane, the Stramit Queenslander Quad® drains 34sqm, and Quad 150 drains 38sqm
- Stramit Queenslander Quad® requires 4 downpipes; the Quad 150 will require 3 downpipes (roof area /drainage area)
- Check gutter overflow in table 9.3
- The roof run length was 4.76m
- Using Stramit Queenslander Quad®, the project allows the use of conventional gutter fixing provided slots are incorporated in the front of the gutter
- These will provide up to 0.5 litres/second/metre of gutter and complies with the NCC
- Table 9.1 states that the gutter must be supported by brackets at a maximum of 1200mm centres
- This table also recommends the use of 100mm round downpipes to maintain the smooth look
- Table 9.13 confirms the Stramit® metal fascia can be installed with brackets at every second truss

7. Suspended concrete slab design

(Refer to chapter 13)

The house has an attached outside deck which is the full width of the house (8m) and is 3m wide.

- Balcony areas require a live load of 2kPa, so refer to Table 13.1 and use a load of 3kPa
- The solution is to use a 120mm slab on 0.75mm Condeck HP® using 25mPa concrete
- Please note there may be distortion in the Condeck HP® trays, but this is visual only and performance is not affected
- To achieve this, one row of temporary (or permanent) props are required to support the deck until the concrete has cured
- A single layer of F62 reinforcing mesh should also be used in the top of the slab to help prevent surface cracking during curing

8. Purlin design

(Refer to chapter 10)

Above the deck is a simple C section structure supporting Stramit Sunset® Patio roofing. The Sunset® is spanning 900mm and the purlins span 4000mm in a double unlapped span.

- Using table 10.1, a C10015 can be spaced at 1000mm centres for the 4m double span
- One row of bridging and standard M12 bolts complete the design

9. Floor design

(Refer to chapter 14)

- Design the main floor area of the house using principles outlined in Chapter 14
- The main floor bearers will always be parallel to the roof ridge line
- Estimate the floor joist length from the distance between the side walls
- As a rule, joists cannot exceed 6m spans, so in this case the 8m wall to wall distance will require a centre run of back-to-back bearers
- Therefore, the floor joist length is 4m
- Next, determine the required distance between the piers along the bearer (the bearer span)
- To allow for easy access below the building, and keep piers to a minimum, we are using a 3m bearer span
- We will have 5 piers per bearer run, for a total of 15
- For the best advantage, we use the bearers over at least two spans (continuous)
- Refer to table 14.2 for the initial joist sizing
- The solution is J23512 joists and B23519, or B23524, bearers
- To design the external bearers under the side walls we need to determine:
 - the roof material, in this case, metal roof cladding
 - the Roof Load Width (RLW), which in this case is the 4m joist plus the 600mm roof overhang
- In table 14.6, using a RLW of 5 and a joist span of 4m, the required bearer is a B18224
- As all joists and bearers need to have the same depth, this needs to be changed to a B23524
- All external bearers require FCB3 brackets screwed with 4 fasteners at each pier

10. Roller doors selection

(Refer to chapter 15)

Both the house and the garage have roller doors that are part of the external envelope of the structures.

- Both structures have openings approximately 3m wide
- In table 15.2, the Taurean® Pr1me Series roller door using Windlocks for a N2 wind load classification is found to span to over 5m; performance is therefore OK
- The roller door tracks need to be secured every 2.2m
- Ensure the abutment forces given in table 15.3 are allowed for in the structure design

Notes:

Notes:



18. Helpful information

Delivery requirements and conditions

STRAMIT'S DELIVERY SERVICE IS TAILORED ACROSS THE COUNTRY TO SUIT LOCAL CONDITIONS AND COMPLY WITH COUNCIL REQUIREMENTS

Delivery times

Stramit's delivery service varies across Australia, so please refer to the *Product and Service Guide* for your area to ensure you take into account our delivery schedule when placing your order.

Specific delivery times

Specific delivery times can be arranged when placing your order. Simply request an 'on site time' and your delivery time and day will be confirmed. Special delivery times outside normal working hours will incur additional charges, which will be provided when you place your order.

Site delivery instructions

We want to make sure we can safely and efficiently unload your delivery when we arrive on site. Completing the *Site Delivery Instruction Form* ensures we have all the information we need to plan for a smooth delivery and unload.

Unloading

Our deliveries are undertaken in accordance with local council or site requirements. Our driver is responsible for unloading the delivery if it can be:

- handled by the driver alone, or
- craned off to the ground level using a truck-mounted crane.

Our customers are responsible for unloading the delivery if the products are:

- more than 13.5m long, or
- exceed the truck-mounted crane reach and loading.

Major projects

Major project work deliveries are negotiated separately. Contact your account manager or local Stramit office for more information.

Customer pick-ups

To arrange a pick-up, please contact your local Stramit office at least one day before the proposed pick-up to organise a loading time. The same applies if you organise for a carrier to do the pick-up on your behalf.

Long length deliveries

Specific times of travel for the delivery of long-length products do apply and will vary according to the time of year. Long length dimensions are defined differently across regions so please refer to your local *Product and Service Guide*.

Escorts

In cases of particularly long-length deliveries, you will be required to arrange escorts, which we can help you with. Please note that it can take a minimum of 28 days to organise a police escort permit.

Design software

BUILDING MADE EASY WITH OUR ONLINE TOOLS

Our design software makes it easy to design and build with Stramit® steel building products.

Stramit® Ex-facta™ software version 1.5

- Design software for Exacta® purlins with Stramit® bridging
- Makes design for irregular configurations and complex loadings easy
- Displays section efficiencies within each span
- Critical and over-designed sections seen at a glance
- Exclusive to Stramit® products and suitable for most Windows® operating systems

Stramit Condeck HP® slab designer software version 3.0

- Includes slab design with point loads
- Makes easy design of continuous slabs with negative reinforcing
- Calculates slab design to suit the required fire rating
- Includes design for stacked loads on formwork
- Suitable for concrete on steel framed buildings

Stramit Patio Spanner™ software version 1.1

- Quick selection of patio roofing spans
- Prepared specifically and exclusively for the design of patio roofing using Sunset®, Monoclad®, Stramit Longspan®, Speed Deck Ultra® and Stramit® Corrugated
- Suitable for most Windows® operating systems

Go to stramit.com.au/resources to register for a copy of our software, or contact us to request copies.

Our technical services team

TAKE ADVANTAGE OF OUR TECHNICAL KNOW-HOW

Our technical services consultants are your trusted advisors when it comes to developing the right solution for your project.

You can count on their product knowledge, technical expertise and practical experience to create real value: design efficiencies, reduced building costs and quick and easy installation.

When you work with our consultants, you can expect:

- Specification support where we'll work alongside you during the design stage to help you select the right products and resolve design challenges as they come up
- Technical support to answer your queries and provide specialist advice
- Field engineering where we'll visit your job site to assess design challenges and provide Stramit-engineered solutions, as well as investigate any product performance issues
- Personalised training in Stramit's design tools and software, and
- CPD seminars to support your professional development

Contact our technical services consultants to find out more about how they can support you at techsupport@stramit.com.au.

Material warranties

REST EASY KNOWING STRAMIT'S GOT YOU COVERED

Stramit manufactures steel building products from high quality materials to ensure reliability and long life.

Our performance-backed guarantee is covered by warranties in the unlikely event faulty materials affect the performance of our steel building products.

To obtain an estimate of the warranty period for your specific ZINCALUME® steel or COLORBOND® steel application, view sample warranties, determine eligibility criterion, or apply for your warranty online, visit the BlueScope Steel website*.

For ZAM® and MagnaFlow® warranties, please contact your local Stramit office as these are offered to projects and determined by the exposure conditions.

Taurean Door System's Roller and Sectional Door warranty covers domestic installations only, and includes a 12-month warranty on steel cracking, lock seam failure of the door curtain and all other door items. Excluded from the warranty is salt corrosion or any damage to the door curtain from any environmental conditions or issues.

Go to stramit.com.au to find out more about your performance warranty.

**BlueScope Warranties are available for BlueScope steel products depending on product selected and end use. Warranties are subject to application and eligibility criteria. For full terms and conditions and to determine the eligibility of your product for the warranty visit bluescopesteel.com.au/warranties.*

Loading advice

YOUR SAFETY IS OUR PRIORITY WHEN IT COMES TO TAKING DELIVERY OF YOUR STRAMIT® STEEL BUILDING PRODUCTS

Overhang limits

We have a simple rule we apply to loading deliveries: if it obstructs your driver's view then it's not happening.

We also recommend a 450mm square bright red flag attached on loads where the overhang is not seen easily. The flag is mandatory for overhangs 1200mm long or more.

THE DRIVER'S VISION MUST NOT BE OBSTRUCTED

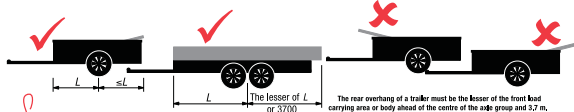
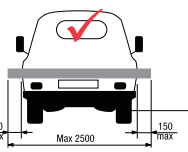
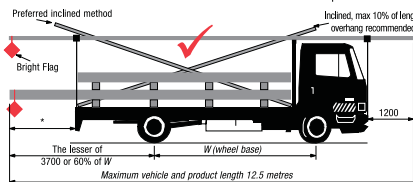
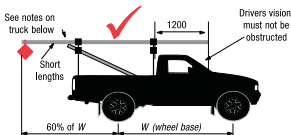
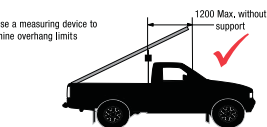
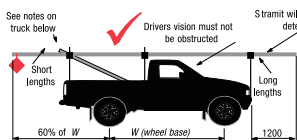
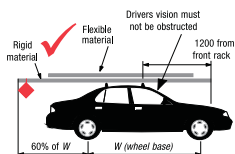

A 450MM SQUARE BRIGHT RED FLAG IS REQUIRED ON ANY OVERHANG THAT CANNOT BE EASILY SEEN (MANDATORY BEYOND 1200mm)

Secure your load

We don't want you to lose your materials in transit so take the time to secure your load. If we think your vehicle can't handle the load, then we won't load it. It's as simple as that.

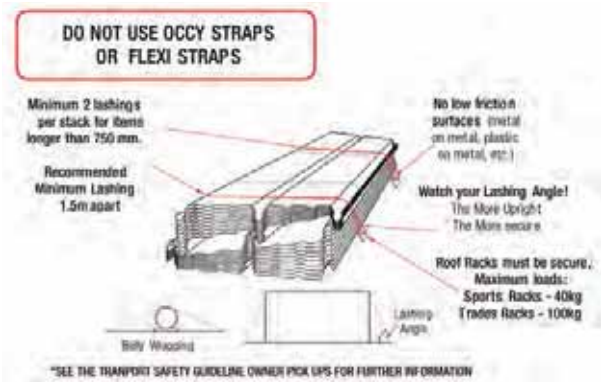

Table 18.1 Lashing requirements

Lashing angle to horizontal	25mm hand tightened webbing	25mm ratchet webbing	35mm ratchet webbing	8mm synthetic rope with single hitch
60 to 90°	52kg per strap	170kg	430kg	87kg per rope
45 to 60°	46kg per strap	140kg	350kg	71kg per rope
30 to 45°	30kg per strap	100kg	250kg	50kg per rope
15 to 30°	15kg per strap	52kg	130kg	26kg per rope

Key assumptions

1. All lashings are fully tensioned. If not, then more lashings may be required.
2. No low friction surfaces e.g. steel on steel, plastic on plastic, plastic on steel, etc.
3. A minimum static coefficient of friction of $\mu = 0.40$ is achieved under all products and between layer of a load. (e.g. rubber or timber against steel or plastic).
4. Round loads require belly wrapping and extra restraints.

Crane to roof alternative

For projects in Brisbane, Sydney and Melbourne or locations within 100 kilometres of the metros, consider the crane to roof alternative. Benefits include:

- Crane and truck in one - product and crane arriving at the same time so there's no need to coordinate multiple services
- Time savings - one coordinated product and crane load with the unit ready to lift within 20 minutes
- Affordability - you don't pay for separate crane and product deliveries and you pay for what you use
- Safe and reliable - fully trained crane operators use wireless technology to best position product into location, and
- Proven - it's proven successful in multiple locations across Australia and New Zealand

If you're in the vicinity of the locations we operate this service and would like to learn more, simply contact your local Stramit office 48 hours beforehand to secure it for your next project.

Your account manager will also be able to provide you with further information, including a quote.

Service promise

STRAMIT CUSTOMERS KNOW WHAT TO EXPECT EVERY TIME THEY WORK WITH US

Our customers are at the heart of everything we do so we think it's important to spell out the service experience they can expect every time they work with us.

Stramit's *Declaration of Done*[®] is our set of promises to our customers. And we don't make promises lightly.

We measure ourselves against what we say we'll do and share the results with our customers so we can work together to make business even better for them. It's our way of making sure we don't let our customers down where it counts most - and that's what sets us apart from the rest.

Find out more about service promise terms and conditions on our website at stramit.com.au.

Our promise to you

 <p>ON-TIME DELIVERY</p> <p>We'll deliver in full, on-time and to specification or we'll credit you 5% of the order confirmation value. Give us 2 days' lead time without making a change and we'll double it to 10%.</p>	 <p>GREAT QUALITY PRODUCTS</p> <p>Great quality products every time, or we'll replace them at no cost to you.</p>	 <p>BEST STOCK AVAILABILITY</p> <p>With our most popular items always in stock, we have what you need, when you need it.</p>	 <p>AUSTRALIA WIDE COVERAGE</p> <p>With a national footprint and local teams covering every State and Territory, we'll work together to get your job done.</p>
 <p>PERSONAL SERVICE</p> <p>You'll be supported by an experienced sales team backed by a network of technical experts.</p>	 <p>RESPONSIVE SUPPORT</p> <p>You'll speak to us within 6 rings and we'll always keep you informed.</p>	 <p>FAST ORDER CONFIRMATION</p> <p>Accurate same day order confirmation, allowing an extra day for structural products, or we'll credit you \$50.</p>	 <p>ACCURATE INVOICING</p> <p>Your invoice will be accurate or we'll credit you the difference plus \$50 within 5 days.</p>

Trade customers only. Terms and conditions apply. Visit stramit.com.au for details.

Site conditions checklist

YOUR SITE CONDITIONS MATTER

We want to know as much as we can about your site conditions so we can deliver your building products safely and efficiently.

Help us avoid delays by providing the following information about your site conditions when you place your order.

	YES	NO
1. Is the area designated for unloading within the safe zone? (see below)		
2. Is the location clear of steep slopes, trenches, muddy and uneven ground so the crane can be used safely?		

If you've answered no to at least one of the above, our customer service and transport teams will work with you to identify an alternative delivery and unloading solution.

State-legislated safe zones distances for overhead lines and cables (up to 132kV)

State	No-Go Zone	Spotter Required	Safe Zone
NSW	0–1.8m	1.8–3.0m	3.0m or more
VIC	0–3.0m	3.0–6.4m	6.4m or more
QLD	0–3.0m	3.0m or more	
SA	0–3.0m	3.0–6.4m	6.4m or more
TAS	0–3.0m	3.0–6.4m	6.4m or more
WA	0–6.0m	6.0m or more	

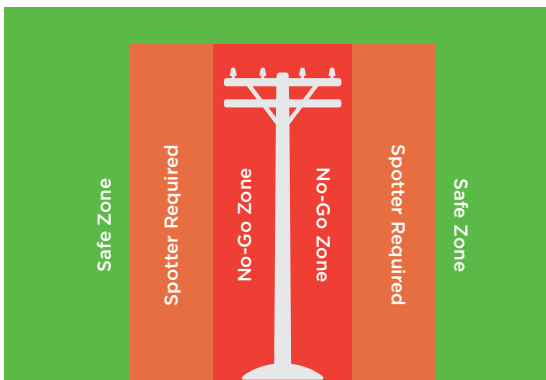

Flammability

FIRE RESISTANCE IS AN IMPORTANT TOPIC FOR EVERYONE IN OUR BUILDING INDUSTRY, INCLUDING PRODUCT MANUFACTURERS, ARCHITECTS, BUILDERS, ENGINEERS AND INSTALLERS

The National Construction Code (NCC) sets out technical provisions for the design, construction and performance of buildings throughout Australia, which include criteria for the assessment of building elements under fire conditions.

Part C1 of Volume One of the NCC 2019 states the provisions that need to be met for fire resistance and stability when proposing a Deemed to Satisfy solution. As stated in Part C1.9, building elements in certain types of fire resisting construction, for example external or common walls, load bearing internal walls, etc., must have all components that are non-combustible. Stramit® wall sheeting used in this type of construction must meet this requirement. Part C1.9(e) gives a list of materials that may be used where non-combustible components are required. One option is metal sheeting with a combustible surface finish less than 1mm in thickness, with a Spread of Flame Index not exceeding 0.

Similarly, in Volume Two of the NCC 2019, Part 3.7 sets out the requirements for Fire Safety, and Part 3.7.1 states the Fire properties for materials and construction. The Acceptable Construction Practice includes a section 3.7.1.1 on General concessions – non-combustible materials. One of the options mentioned here as non-combustible is metal sheeting with a combustible surface finish less than 1mm in thickness, with a Spread of Flame Index not exceeding 0.

Stramit® roofing, cladding, rainwater and structural building products are manufactured from steel produced by BlueScope or Pacific Coil Coaters (through Selection Steel). Both organisations have had independent tests on their materials carried out by CSIRO or AWTA. The testing was conducted in accordance with the Australian Standard AS 1530.3 Simultaneous Determination of Ignitability, Flame Propagation, Heat Release and Smoke Release. All materials had a surface finish less than 1mm in thickness and a Spread of Flame Index of 0. More detail is given in table 18.2.

Table 18.2 Technical summary

Steel source	Base Metal Thickness (mm)	Finish	Certificate Number	Ignitability Index (0-20)	Spread of Flame Index (0-10)	Heat Evolved Index (0-10)	Smoke Developed Index (0-10)
BlueScope	0.35	COLORBOND® steel	FNE11605	0	0	0	2
BlueScope	0.70	COLORBOND® Metallic steel	FNE11604	0	0	0	2
BlueScope	0.42	ZINCALUME® steel	FNE11602	0	0	0	2
BlueScope	0.55	SUPERDURA™ Stainless steel	FNE11606	0	0	0	1
BlueScope	0.42	Galvanised	FNE11600	0	0	0	2
Pacific Coil Coaters	0.42	MagnaFlow®	19-002186	0	0	0	3

Stramit® products made from these steel sources and with the tested finishes would be considered non-combustible according to NCC 2019 Volume One Part C1.9(e) and Volume Two Part 3.7.1.1.

It is important to note that Stramit® sheeting is only one component used in construction of these building elements, and other components must also meet the necessary requirements to satisfy the criteria.

For information on performance of residences in a bushfire situation, please refer to the bulletin based on the NASH Bushfire Standard on the BlueScope website.

For further information about our products including their fire resistance, please contact our technical services team at techsupport@stramit.com.au.

Glossary

accessories

Ridge, gable and hip capping, flashings, brackets and small add-on components, and fasteners.

acoustic blanket

Glass fibre blanket for sound insulation.

anti-capillary feature

A designed shape in the rolled profile that creates a gap wider than 1 mm at the side lap of installed sheets that prevents capillary action drawing rainwater into the side lap.

apron flashing

Horizontal drainage flashing, the lower edge of which is lapped over the roof covering, such as at the top end of a skillion roof or on the lower side of a chimney penetration.

astragal

A strap or hook for securing downpipes to walls.

barge

Sloping board fixed to a gable to conceal the roof construction, fixed parallel to the roof slope. Often the same material as fascia.

batten

Small structural section to which roofing or ceiling sheets, tiles and slates are fixed. Can be metal or timber.

BCA

Building Code of Australia. A uniform set of technical requirements and standards for the design and construction of buildings and structures throughout Australia. Now called the National Construction Code (NCC).

beam

A structural member that supports a load primarily by its internal resistance to bending. Main structural beams can also be called girders.

bearer

Sub-floor structural member that supports the joists.

BMT

Base metal thickness. Dimension of the underlying metal, excluding any coating.

bridging

Member used between purlins and girts to limit rotation and lateral deflection.

building blanket

Glass fibre (or other material) in blanket form usually for thermal insulation.

cantilever

Portion of a beam or structural slab that projects beyond its last support.

capillary action

Natural process in which water is drawn between two surfaces that are close together.

capping

Protective covering, usually between adjacent building surfaces, e.g. hip capping or ridge capping.

ceiling

Lining surface covering the underside of a floor or roof.

chord

The long members at the top and bottom of a truss.

cladding

An external cover to a building or structure.

cladding system

Roof or wall cladding, accessories and fasteners. A cladding system is defined by a single profile, sheet thickness, material grade and specification, fastener type and size, fastener spacing, and washer configuration. It can have various spans or span types.

COLORBOND® steel

COLORBOND® steel is a pre-painted steel product manufactured BlueScope that is tested for Australian conditions and comes in a wide range of colours and finishes.

composite deck

Left-in-place metal formwork that acts as all or part of the slab reinforcement.

compression

Forces trying to shorten a member, sometimes leading to buckling, the opposite of tension.

concealed - fastened

A roof or wall cladding fixed by means of hidden, or secret, fixing clips or brackets.

cover

The width of roof or wall cladding that remains exposed when it is installed.

crank curving

A method of creating a small radius on roof sheeting through a series of parallel rib deformations.

creep

1. The phenomenon of increasing deformation under constant load.
2. An increase in sheet cover during installation, often caused by overtightening of the fasteners.

crest fixed

Roof (or occasionally wall) cladding attached by means of a screw through the top (crest) of a rib.

cross sectional area

For eave gutter profiles, the area beneath a line not less than 10mm below the overflow provision of the gutter or with internal brackets less any allowance for the effects of the brackets as determined by the manufacturer. Sometimes called Effective Cross Sectional Area (ECSA).

cyclonic regions

Regions C and D as defined in AS/NZS 1170.2. For cladding this area requires different testing methods and hence, load tables.

damp proof course

Continuous layer of waterproof material built into a wall or pier to prevent upward or downward movement of water.

datum

The defined point from which surveys or measurements are taken.

deck/decking

1. Secret-fixed roof sheeting, usually on a low-pitched roof
2. Composite formwork sheeting

deflection

The sag or movement of any building component or assembly under a load, often just self-weight.

de-indexing

The releasing of the interlock between preformed sheets.

dovetail

A joint or sheeting rib that has an interlocking shape resembling a dove's tail.

downpipe

A pipe to carry roof water from gutters or roof catchments to drains or storage tanks.

eave

The lower edge of a pitched roof or edge of a flat roof that overhangs the wall. Eaves provide shade and direct rainwater clear of the walls below.

eave gutter

Internal (concealed) or external roof gutter attached to an eaves overhang.

ECSA

See cross sectional area.

end lap

Distance by which the upper sheet, tile or other roofing material overlaps the top end of the one immediately below it to provide resistance to weather.

expansion joint

A vertical or horizontal movement-control joint which permits axial movement in long runs of gutter, roof sheet or flashing due to thermal expansion or contraction with changes in temperature, or creep.

fall

The slope (or pitch) of the roof or gutter, usually expressed in degrees, or as a ratio of vertical height to horizontal distance. (e.g. 1 in 20).

fascia

A wide, horizontal board fixed to the ends of rafters or truss top chords, usually supporting guttering. Often made in metal for domestic construction.

fastener

The screw, pop rivet or bolt that fixes components together.

fastener spacing

The maximum distance between fasteners, measured along the centre-line of the supporting member.

FER

Fire Emergency Reinforcement used in a suspended concrete slab to carry the evacuation loads during a fire.

Fire Rating

Usually means Fire Resistance Rating (FRR) and is given as three numbers, e.g. 120/120/90. These are the required periods of resistance in minutes to structural adequacy/integrity against flame and smoke/insulation against heat. An FRR of 120/120/120 is commonly referred to as a two-hour fire rating.

fixing

Joining one component to another, also the devices such as screws and bolts used to fix cladding and supports to a building.

flange

The upper or lower horizontal part of a rolled structural shape.

flashing

A strip or sleeve of waterproof material that provides a barrier to water movement, or diverts water, that would otherwise enter a building. Types include apron, soaker, transverse, hip or valley flashing.

footing

The ground preparation, usually concrete filled, for a post, stump, pier, column or wall.

foot traffic

In the context of metal roofing this refers to foot loading from the fixers and subsequent occasional maintenance. It does not mean suitable for routine walking.

formwork

A structure, either temporary or permanent, provided to contain fresh (green) concrete and support it in the required shape and size until it can self-support the loads upon it.

gable

Portion of a wall above the level of the eaves that encloses the end of the space under a pitched roof.

gable end

End wall of a building with a gable.

galvanised

Steel coated with a protective layer, made by dipping it in molten zinc.

girt

A horizontal rail in a steel-framed building, usually a C or Z section, supporting wall cladding.

gutter

A channel or section for collecting and carrying away rainwater, normally from a roof.

hex head

Short for hexagon-headed screw, often on a self-drilling and tapping screw. Easier to drive than wafer headed screws.

high tensile

Commonly used to describe high strength steel. 'Hi-Ten' is the BlueScope brand/trademark for their steel.

hip

At the top of the inclined meeting line of two slopes in a pitched roof.

Hilti pin

Proprietary brand of metal fastening pin that is explosively fired into the receiving material, such as steel.

insulated panel

An insulated laminated roofing panel that is manufactured from different materials, with metal sheets on the outside and generally, a foam-based core, permanently bonded together so they act as a single structural element.

joist

One of a series of parallel beams, usually horizontal, spaced at regular intervals and directly supporting a floor or ceiling. Often supported by bearers.

knurled

A rough surface finish produced by mechanical processing, usually to provide a slip-reducing surface.

kPa

kilopascal - a common metric measuring unit for pressure.

load

A force or action that acts on a structure or a structural member. A load can be a live load (e.g. rain, wind, foot traffic or other moving or dynamic loads from usage) or a dead load (e.g. stationary or constant loads from walls, air conditioning units or component mass).

Limit State

The condition for which a system is designed, beyond which it ceases to fulfil its function and becomes unusable. The most commonly used are Strength (or Ultimate) Limit State and Serviceability Limit State. Others include Stability Limit State.

linearity

The straightness of a component or a line.

MagnaFlow®

PCC's brand/trademark for their pre-painted ZAM® steel sheet.

mansard

A roof built with two slopes, the lower part rising steeply from the eaves, the upper portion of the flatter slope rising to a central ridge.

moment

The turning effect of a force about a given point.

NCC

The National Construction Code which is a uniform set of technical requirements and standards for the design and construction of buildings and structures throughout Australia.

nogging

Also known as a noggin. A short strut fixed between studs or joists to provide lateral stiffening and sometimes as intermediate fixing points for the covering material.

non-cyclonic regions

Regions A and B as defined by AS/NZS 1170 part 2.

notch

A small piece cut away from a component to provide clearance against another component or to fulfil a function such as drainage.

NRC

Noise Reduction Coefficient – the index of the sound absorbing efficiency of acoustic materials with a maximum value of 1.0.

oil canning

Minor elastic distortion, in the form of waviness, in a pre-formed sheet of metal. Often if pushed with a finger, the metal may pop back and forth with change in pressure, like the bottom of an old-fashioned oil can.

over tightening

Where the screws on a pierced fixed roof are driven too far, creating distortion about the screw head and often, increased roof noise.

PA door

Personal access door. A door that is sized to admit a person rather than, for example, a vehicle.

pan

The flat or curved portion between the ribs in a metal sheet, also known as a trough or a tray.

pan-fixed

Used to indicate that wall (or possibly roof) cladding is fixed through the pan or trough of the profile.

patina

A coating caused by oxidation on the surface of some metals.

penetration

A projection through the roof (e.g. vent pipe, lift well, air conditioning, roof light).

pier

A vertical structural member that transmits to its base the compressive forces applied to it. Usually used in residential construction.

pierce fastened profile

A metal cladding fixed by screws through the exposed metal sheet.

pile

A structural member that transmits loads to the underlying soil and provides a foundation for a structure.

pitch

1. The inclination of a roof, rafter, etc, measured in degrees from the horizontal.
2. The distance between ribs on a roof or wall profile.
3. The distance between supports such as trusses.

plate

A horizontal structural member, supported by a wall, bearers or joists, in turn supporting and distributing the load from floors, walls, roofs and ceilings.

podger bar

A pointed end tool used by fabricators to position purlins into place. Often includes a purlin bolt spanner at one end.

ponding

Retention of rainwater, caused by deflection of a flat or slightly inclined roof.

positive reinforcement

Reinforcing bar used mostly near the centre of span of a concrete slab to resist what is known as a 'positive moment'.

post

A simple form of vertical column or pier used to support some part of a structure.

preformed sheet

A metal roofing sheet preformed to increase its resistance to vertical loads. It may have longitudinal ribs of corrugated type or of pan type, in which the distance between the ribs is greater than the width of the ribs or be formed in other ways to represent tiles or other shapes.

prop/propping frame

Temporary support fitted beneath a beam or formwork to support loads during construction.

purlin

A beam parallel to the eaves that gives internal support to the roofing.

R-Value

The thermal resistance ($m^2.K/W$) of a component calculated by dividing its thickness by its thermal conductivity.

rainwater goods

Gutters, downpipes, rainheads, sumps, spreaders, soakers, nozzles and eaves, box and valley.

rib

A longitudinal upstand produced by roll forming, bending, folding or crimping.

reinforcement/reo

Rods, bars or mesh, usually of steel, embedded in concrete for the purpose of resisting tensile or shear stresses.

ridge

The intersection at the top of two slopes in a pitched roof, which forms the apex (top) of the roof.

ridge capping

Covering over the ridge that provides a continuous cover and weather seal between the two slopes.

roof run length

Used for roof drainage calculations. It is the sum of the lengths of each part of roof pan or trough that will direct rainwater to the lower edge of a roof.

roofing wire

Usually means roof safety mesh.

sarking membrane

Pliable, water-resistant membrane for use beneath the external roof or wall covering to collect and discharge any water that may penetrate, or water vapour that may condense on it. Also may offer thermal reflectance.

safety mesh

Steel wire mesh designed to prevent anyone from falling during roof construction.

scribe

Cut a piece of material to fit the profile of another to which it is to be fitted.

section

One of a variety of structural cross sections used as structural members.

secret-fixed

The fixing of cladding material using secret (hidden) brackets, clips, etc., in such a way that the method of fixing is not visible when it is completed.

serviceability

The functional and aesthetic requirements of a component, assembly or structure.

Serviceability Limit State

States that correspond to conditions beyond which specified service criteria for a structure or structural element are no longer met.

shear stud

A solid steel pin with a thick head that is welded to steel beams to enable them to act in unison with concrete in a beam or slab. Sometimes welded directly through composite decking (such as Condeck HP®).

shielding

A factor used in wind load calculations indicating the size and number of similar sized obstructions that surround a structure. Shielding can reduce wind loads.

shoe

A fitting at the foot of a downpipe to discharge rainwater clear of a building.

side lap

The distance by which a sheet of roofing material overlaps the side of the one immediately beside it in order to provide weatherproofing.

side overflow device

An overflow device fitted to a box gutter to discharge all roof water clear of a building due to total or partial blockage of outlets, downpipes or storm water drains.

skillion

A monoslope (single-pitched) roof without a ridge.

slab

A flat, relatively thin but rigid piece of material, usually of rectangular cross section. A solid slab is one containing predominantly one material, e.g. concrete. A composite slab is a concrete slab that incorporates profiled steel sheeting as a permanent soffit formwork that acts as slab reinforcement.

soaker gutter

A flashing type gutter on the upper side of a chimney or similar roof penetration.

soffit

The exposed horizontal or sloping under-surface of an eave.

span

The distance between points capable of giving support.

span types

Single, double or multiple spans within a cladding or purlin run.

spreader

1. A device fitted to the foot of a downpipe to evenly distribute rainwater onto a roof at a lower level in the direction of flow.
2. A bar or fabricated beam used to support packs of cladding at multiple points.

spring curving

A curve in roof or wall cladding produced from manual bending of straight sheet during installation due to its inherent flexibility.

stillage

A frame or assembly for storing materials or components.

Strength Limit State

State associated with collapse or with other similar forms of structural failure.

stud

One of a series of vertical members in a wall.

sump

An internal collector of water from a gutter system for discharge to a connecting downpipe.

SUPERDURA™ Stainless steel

SUPERDURA™ Stainless steel range for Roofing and Walling is especially designed by BlueScope for Very Severe Coastal & Industrial Environments.

supporting member

The member to which the cladding is attached, e.g. purlins, battens, girts.

suspended slabs

Above ground concrete slabs supported by walls or beams.

swarf

Metallic filings and debris removed from a material during cutting, drilling or machining.

TCT

Total Coated Thickness. The thickness of the material measured over the coating surface. Due to the wide variety in coatings, no longer used in material specifications.

tea-staining

A brown marking sometimes found on stainless steel, particularly in salty environments.

Tek screw

ITW Buildex brand/trademark for a self-drilling, self-tapping screw.

tension

Pulling or stretching force, the opposite of compression.

terrain category

A design factor used in Australian Standards Wind Loading Code to account for the effect of the ground roughness conditions (trees, houses, etc.) for a few kilometres in the direction from which the wind is blowing.

thermal expansion

Changes in product dimension (e.g. length) that occur as temperature changes.

top hat

A structural section, similar to a batten, shaped roughly like an old-style top hat in cross section.

topography

A factor used in the determination of wind load. Structures built on the top two thirds of a hill may have increased wind loads.

trafficable

A roof that is suitable only for light foot traffic such as that imposed by skilled roofers during installation and maintenance.

translucent sheeting

Preformed clear or coated sheeting (e.g. fibreglass, polycarbonate or webglass) that allows certain percentage of light into the project through the product.

truss

One of a series of triangulated plane frames used to support a roof.

unclipping

The releasing of preformed sheets from their fixing clips and fastenings.

valley

The resulting V shaped area at the bottom of the meeting line of two slopes in a pitched roof

vapour barrier

A layer of material or component intended to restrict the transmission of water vapour.

void

Air spaces within the bulk of a material or within an assembly.

web

Usually the major element of a structural member.

wind load

Live load due to wind, usually in the form of pressure.

ZAM[®]

Nisshin Steel's brand/trademark for steel coated with an alloy of zinc, aluminium and magnesium.

ZINCALUME[®] steel

ZINCALUME[®] steel is the BlueScope trade name for steel coated with an alloy of aluminum, zinc and magnesium.

Timber poles used in structures

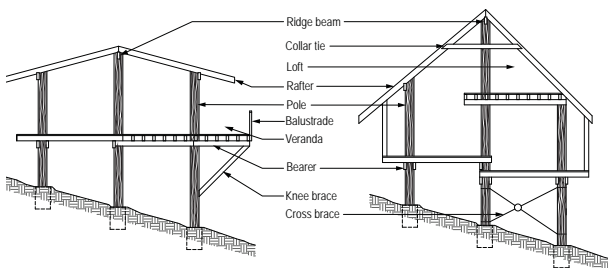

Brick and brick veneer construction

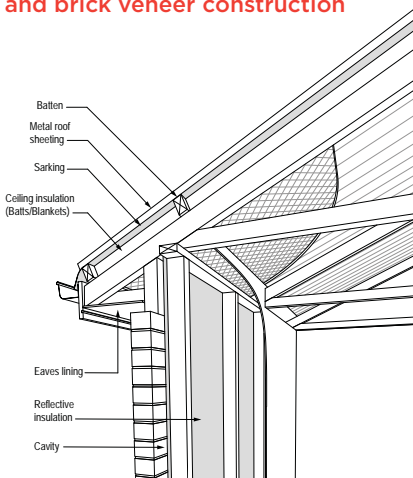

Framing members - gable roof construction

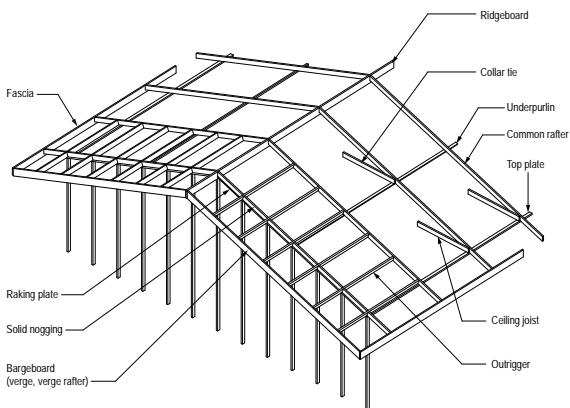

Timber frame construction

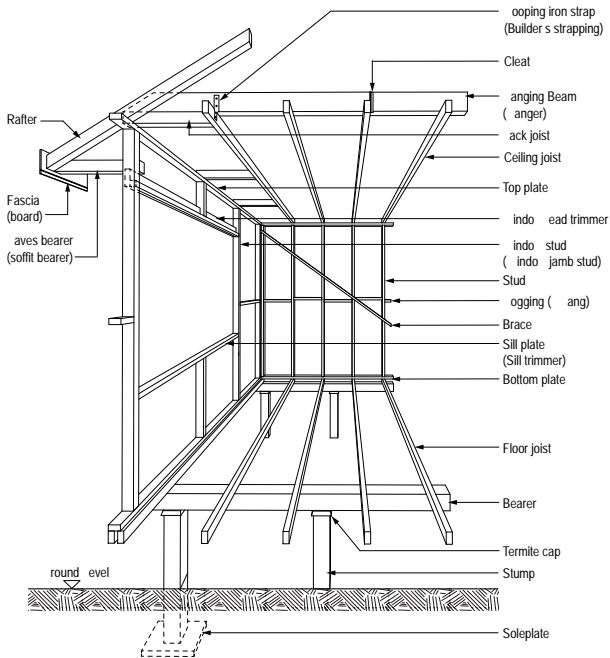

Framing members - hip and valley roof construction

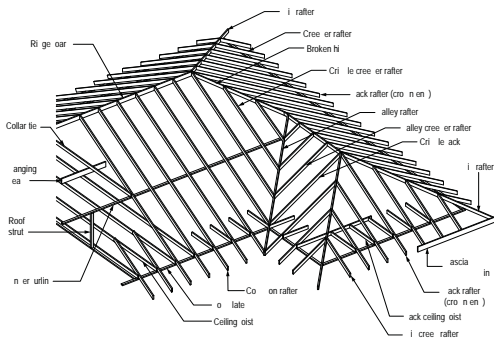

Skillion roof

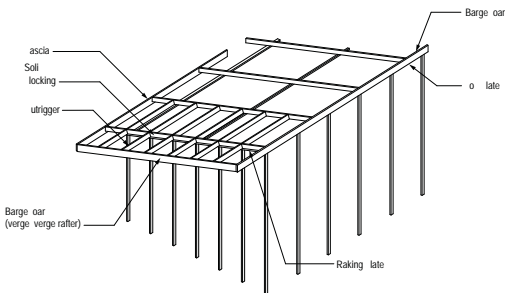

Hipped roof take-off estimate

SOMETIMES YOU NEED TO DO A QUICK CALCULATION TO SEE IF THE NUMBERS STACK UP. WE GET IT.

Our table of roof slope factors will help you do the maths when it comes to roof areas, sheet length and hip length. Remember, these methods are for quick estimating purposes only. Accurate measurements must be taken from the actual roof frame before ordering roofing and rainwater products.

As an example, take a typical hipped roof where all four roof sections have the same slope (30 degrees) and all hips are of equal length.

Typical hipped roof (roof slope = 30°)

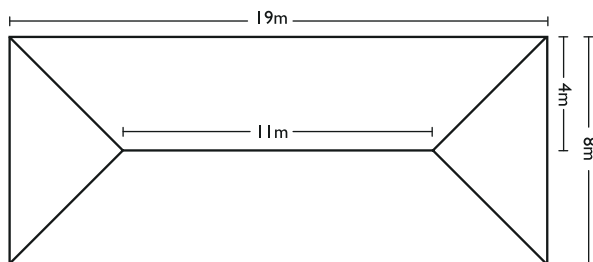

Refer to the Stramit® *Roof Take-offs Made Easy - Roof Quantity Estimate Guide* for further information.

Roof area

First determine the area of the roof plan by multiplying the length of the roof by the width. Before making the calculation, add gutter overhangs of 50mm. To find the area of your hipped roof, simply multiply your plan area by the Roof Slope Factor for the roof area. The same method is used for gable roofs. If we apply our example, the equation is as follows:

$$19.1 \times 8.1 = 154.7 \times 1.155 = 178.7\text{m}^2$$

Roughly 179m² of sheeting will be needed to cover the roof. On complex roof shapes, extra may be needed to allow for wastage.

Sheet length

On the roof plan, measure the distance from the line of the ridge to the outside of the fascia, which in the example we've provided is half the span or 4000mm. Multiply this measurement by the Sheet Length Roof Slope Factor to find the length of the sheet required to span from the ridge to the fascia. Note that all roof sheeting must extend at least 50mm beyond the fascia line to provide gutter overhang.

$$(4000 + 50) \times 1.155 = 4678\text{mm}$$

Hip capping

To find the length of ridge capping required to cover one hip, measure the distance from the ridge line to the fascia on the roof plan (here 4000mm) and the gutter overhang and multiply by the Hip Length Roof Slope Factor for 30 degrees. Multiply by 4.

$$(4000 + 50) \times 1.528 = 24.8\text{m}$$

Ridge capping

For hipped roofs where all sides have the same slope, the length of the top ridge is equal to the length of the roof plan minus the width, regardless of slope. Add 5% to all cappings to allow for laps.

$$(19 - 8) = 11 + 5\%$$

Roof slope factors

These roof slope factors can be used for roof takeoffs using the procedure on page 372.

Table 18.3

Roof slope (degrees)	1	2	3	4	5	6	
Roof area/sheet length	1.000	1.001	1.001	1.002	1.004	1.006	
Hip length	1.414	1.415	1.415	1.416	1.417	1.418	

Table 18.4

Roof slope (degrees)	16	17	18	19	20	21	
Roof area/sheet length	1.040	1.046	1.051	1.058	1.064	1.071	
Hip length	1.443	1.447	1.451	1.456	1.460	1.465	

Table 18.5

Roof slope (degrees)	31	32	33	34	35	36	
Roof area/sheet length	1.167	1.179	1.192	1.206	1.221	1.236	
Hip length	1.537	1.546	1.556	1.567	1.578	1.590	

Table 18.6

Roof slope (degrees)	46	47	48	49	50	51	
Roof area/sheet length	1.440	1.466	1.494	1.524	1.556	1.589	
Hip length	1.753	1.775	1.798	1.823	1.849	1.877	

	7	8	9	10	11	12	13	14	15
	1.008	1.010	1.012	1.015	1.019	1.022	1.026	1.031	1.035
	1.420	1.421	1.423	1.425	1.428	1.430	1.433	1.436	1.439

	22	23	24	25	26	27	28	29	30
	1.079	1.086	1.095	1.103	1.113	1.122	1.133	1.143	1.155
	1.471	1.477	1.483	1.489	1.496	1.503	1.511	1.519	1.528

	37	38	39	40	41	42	43	44	45
	1.252	1.269	1.287	1.305	1.325	1.346	1.367	1.390	1.414
	1.602	1.616	1.630	1.644	1.660	1.677	1.694	1.712	1.732

	52	53	54	55	56	57	58	59	60
	1.624	1.662	1.701	1.743	1.788	1.836	1.887	1.942	2.000
	1.907	1.939	1.973	2.010	2.049	2.091	2.136	2.184	2.236

Helpful tables

Table 18.7

Roof run length calculator using the roof plan dimension as the base.

Roof angle (deg)	Roof plan dimension (m)																		
	1	1.5	2	2.5	3	3.5	4	4.5	5	5.5	6	6.5	7	7.5	8	8.5	9	9.5	10
1	1.000	1.500	2.000	2.500	3.000	3.501	4.001	4.501	5.001	5.501	6.001	6.501	7.001	7.501	8.001	8.501	9.001	9.501	10.002
2	1.001	1.501	2.001	2.502	3.002	3.502	4.002	4.503	5.003	5.503	6.004	6.504	7.004	7.505	8.005	8.505	9.005	9.506	10.006
3	1.001	1.502	2.003	2.503	3.004	3.505	4.005	4.506	5.007	5.508	6.008	6.509	7.010	7.510	8.011	8.512	9.012	9.513	10.014
4	1.002	1.504	2.005	2.506	3.007	3.509	4.010	4.511	5.012	5.513	6.015	6.516	7.017	7.518	8.020	8.521	9.022	9.523	10.024
5	1.004	1.506	2.008	2.510	3.011	3.513	4.015	4.517	5.019	5.521	6.023	6.525	7.027	7.529	8.031	8.532	9.034	9.536	10.038
6	1.006	1.508	2.011	2.514	3.017	3.519	4.022	4.525	5.028	5.530	6.033	6.536	7.039	7.541	8.044	8.547	9.050	9.552	10.055
7	1.008	1.511	2.015	2.519	3.023	3.526	4.030	4.534	5.038	5.541	6.045	6.549	7.053	7.556	8.060	8.564	9.068	9.571	10.075
8	1.010	1.515	2.020	2.525	3.029	3.534	4.039	4.544	5.049	5.554	6.059	6.564	7.069	7.574	8.079	8.584	9.088	9.593	10.098
9	1.012	1.519	2.025	2.531	3.037	3.544	4.050	4.556	5.062	5.569	6.075	6.581	7.087	7.593	8.100	8.606	9.112	9.618	10.125
10	1.015	1.523	2.031	2.539	3.046	3.554	4.062	4.569	5.077	5.585	6.093	6.600	7.108	7.616	8.123	8.631	9.139	9.647	10.154
15	1.035	1.553	2.071	2.588	3.106	3.623	4.141	4.659	5.176	5.694	6.212	6.729	7.247	7.765	8.282	8.800	9.317	9.835	10.353
20	1.064	1.596	2.128	2.660	3.193	3.725	4.257	4.789	5.321	5.853	6.385	6.917	7.449	7.981	8.513	9.046	9.578	10.110	10.642
22	1.079	1.618	2.157	2.696	3.236	3.775	4.314	4.853	5.393	5.932	6.471	7.010	7.550	8.089	8.628	9.168	9.707	10.246	10.785
25	1.103	1.655	2.207	2.758	3.310	3.862	4.414	4.965	5.517	6.069	6.620	7.172	7.724	8.275	8.827	9.379	9.930	10.482	11.034

Simply look up the roof angle, and the roof plan length, to determine the roof slope length, usually add 50mm to get the roof sheet length

Table 18.8

Hip or valley length calculator using the same method as table 18.6. The roof plan dimension is the same as in table 18.6.

Roof angle (deg)	Roof plan dimension (m)																		
	1	1.5	2	2.5	3	3.5	4	4.5	5	5.5	6	6.5	7	7.5	8	8.5	9	9.5	10
1	1.414	2.121	2.829	3.536	4.243	4.950	5.657	6.364	7.072	7.779	8.486	9.193	9.900	10.607	11.315	12.022	12.729	13.436	14.143
2	1.415	2.122	2.829	3.537	4.244	4.951	5.659	6.366	7.073	7.781	8.488	9.195	9.903	10.610	11.317	12.024	12.732	13.439	14.146
3	1.415	2.123	2.830	3.538	4.246	4.953	5.661	6.368	7.076	7.784	8.491	9.199	9.906	10.614	11.321	12.029	12.737	13.444	14.152
4	1.416	2.124	2.832	3.540	4.248	4.956	5.664	6.372	7.080	7.788	8.496	9.204	9.912	10.620	11.328	12.036	12.743	13.451	14.159
5	1.417	2.125	2.834	3.542	4.251	4.959	5.668	6.376	7.085	7.793	8.502	9.210	9.918	10.627	11.335	12.044	12.752	13.461	14.169
6	1.418	2.127	2.836	3.545	4.254	4.963	5.672	6.382	7.091	7.800	8.509	9.218	9.927	10.636	11.345	12.054	12.763	13.472	14.181
7	1.420	2.129	2.839	3.549	4.259	4.968	5.678	6.388	7.098	7.807	8.517	9.227	9.937	10.647	11.356	12.066	12.776	13.486	14.195
8	1.421	2.132	2.842	3.553	4.264	4.974	5.685	6.395	7.106	7.816	8.527	9.238	9.948	10.659	11.369	12.080	12.791	13.501	14.212
9	1.423	2.135	2.846	3.558	4.269	4.981	5.692	6.404	7.115	7.827	8.538	9.250	9.961	10.673	11.384	12.096	12.807	13.519	14.231
10	1.425	2.138	2.850	3.563	4.275	4.988	5.701	6.413	7.126	7.838	8.551	9.264	9.976	10.689	11.401	12.114	12.826	13.539	14.252
15	1.439	2.159	2.879	3.598	4.318	5.038	5.757	6.477	7.197	7.917	8.636	9.356	10.076	10.795	11.515	12.235	12.954	13.674	14.394
20	1.460	2.190	2.921	3.651	4.381	5.111	5.841	6.571	7.301	8.032	8.762	9.492	10.222	10.952	11.682	12.413	13.143	13.873	14.603
22	1.471	2.206	2.942	3.677	4.412	5.148	5.883	6.619	7.354	8.089	8.825	9.560	10.296	11.031	11.766	12.502	13.237	13.973	14.708
25	1.489	2.234	2.978	3.723	4.467	5.212	5.956	6.701	7.446	8.190	8.935	9.679	10.424	11.168	11.913	12.657	13.402	14.147	14.891

Table 18.8 Hip or Valley run length (m) from plan dimensions

Table 18.9

Based on the square metres of a particular Stramit cladding profile, determine the total mass of the material.

Quantity (m ²)	Corrugated		Monoclad®		Stramit® Longspan®		Capacity Plus™660		Speed Deck Ultra®		Stramit Speed Deck® 500		Mini Corry®		Stramit® Minitrb®		Monopanel®		C-Clad 280		Premier 300™		Sunset®	
	0.42	0.48	0.60	0.35	0.42	0.48	0.42	0.48	0.42	0.48	0.42	0.48	0.60	0.42	0.48	0.42	0.48	0.48	0.55	0.55	0.55	0.55	0.42	0.42
1	5	5	7	4	5	5	5	6	5	6	5	6	7	5	5	4	5	5	6	6	6	6	6	6
2	9	10	13	8	9	10	10	11	10	11	10	11	14	9	10	8	10	10	12	12	12	12	12	12
3	14	15	19	11	14	15	15	17	15	17	15	17	21	13	14	12	14	14	17	17	17	17	17	18
4	18	20	25	15	18	20	19	22	19	22	20	22	27	17	19	15	19	19	23	23	23	23	23	24
5	22	25	31	18	22	25	24	27	24	27	24	28	34	21	23	19	23	23	29	29	29	29	29	29
6	27	30	37	22	27	30	29	33	29	33	29	33	41	25	28	23	28	28	34	34	34	34	34	35
7	31	35	43	26	31	35	34	38	34	38	34	39	48	29	32	26	33	33	40	40	40	40	40	41
8	35	40	49	29	35	40	38	43	38	43	39	44	54	33	37	30	37	37	46	46	46	46	46	47
9	40	45	55	33	40	45	43	49	43	49	44	49	61	37	42	34	42	42	51	51	51	51	51	52
10	44	50	61	36	44	50	48	54	48	54	48	55	68	41	46	37	46	46	57	57	57	57	57	58
20	87	99	122	72	87	99	95	108	95	108	96	109	135	81	92	74	92	92	114	114	114	114	114	116
30	131	148	183	108	131	148	143	162	143	162	144	164	202	121	137	111	137	137	170	170	170	170	170	173
40	174	198	244	144	174	198	190	215	190	215	192	218	269	161	183	148	183	183	227	227	227	227	227	231
50	218	247	305	180	218	247	237	269	237	269	240	272	336	201	228	184	228	228	283	283	283	283	283	288
100	435	493	609	359	435	493	474	537	474	537	480	544	672	402	456	368	456	456	566	566	566	566	566	576

Table 18.10

Based on the quantity of a Qld rainwater product, get the total mass.

Table 18.10 Queensland and Northern Territory rainwater product mass (kg / total length shown)

Quantity (lm)	Fascia	Queenslander Quad®	Quad 125	Quad 150	Quad 175	M Pattern	S Pattern	Half Round 150	Half Round 200	Flatback 150
1	1	2	1	2	2	2	2	2	2	2
2	2	3	2	3	4	3	3	3	3	3
3	3	4	3	4	6	4	5	4	5	4
4	4	5	4	5	7	6	6	5	6	5
5	5	6	5	6	9	7	7	6	7	6
6	6	7	6	7	11	8	9	7	9	7
7	7	8	7	8	12	9	10	8	10	8
8	8	9	8	9	14	11	11	9	11	9
9	9	10	9	10	16	12	13	10	13	10
10	10	11	10	11	17	13	14	11	14	11
20	20	22	19	21	34	26	27	21	27	21
30	30	33	29	32	51	39	41	32	41	32
40	40	44	38	42	68	52	54	42	54	42
50	49	54	47	53	85	64	67	52	67	52
100	98	108	94	105	169	128	134	104	134	104

Table 18.11

Based on the quantity of a NSW rainwater product, get the total mass.

Table 18.11 New South Wales and ACT rainwater product mass
(kg/total length shown)

Quantity (lm)	Fascia	Hi Front Quad	Quad 115	Quad 125	Triline SB	Triline HB	Half Round 150	Half Round 200	Flatback 150
1	1	1	1	1	2	2	2	2	2
2	2	2	2	2	3	3	3	3	3
3	3	3	3	3	5	4	4	5	4
4	4	4	4	4	6	6	5	6	5
5	5	5	5	5	7	7	6	7	6
6	6	6	6	6	9	8	7	9	7
7	7	7	7	7	10	9	8	10	8
8	8	8	8	8	11	11	9	11	9
9	9	9	8	9	13	12	10	13	10
10	10	10	9	10	14	13	11	14	11
20	20	20	18	19	27	26	21	27	21
30	30	30	27	29	41	39	32	41	32
40	40	40	36	38	54	52	42	54	42
50	49	49	44	48	67	64	52	67	52
100	98	98	88	95	134	128	104	134	104

Table 18.12

Based on the quantity of a VIC rainwater product, get the total mass.

Table 18.12 Victoria, Tasmania and South Australia rainwater product mass (kg/total length shown)

Quantity (lm)	Fascia	Quad 115	Easiflow	Fascia Gutter	O-Gee™
1	1	1	2	2	2
2	2	2	3	3	3
3	3	3	5	5	4
4	4	4	6	6	5
5	5	5	7	7	6
6	6	6	9	9	8
7	7	7	10	10	9
8	8	8	11	11	10
9	9	9	13	13	11
10	10	10	14	14	12
20	20	20	27	27	24
30	30	30	41	41	36
40	40	40	54	54	48
50	49	49	68	67	60
100	98	98	135	134	119

Table 18.13

Based on the quantity of a WA rainwater product, get the total mass.

Table 18.13 Western Australia rainwater product mass (kg/total length shown)

Quantity (lm)	Strongline® Fascia	Trad-Line™	Easiline® Patio	Easiline® Domestic
1	2	1	2	2
2	4	2	3	3
3	5	3	4	4
4	7	4	5	5
5	8	5	6	6
6	10	6	8	8
7	11	7	9	9
8	13	8	10	10
9	14	9	11	11
10	16	10	12	12
20	31	20	24	24
30	46	29	36	36
40	61	39	48	48
50	76	48	60	60
100	151	96	120	120

Table 18.14

Rainwater in litres collected from a roof plan area based on the amount of rain.

Table 18.14 Water collection (litres)

Rainfall (mm)	Roof plan area (m ²)									
	10	20	30	40	50	60	70	80	90	100
1	0	0	0	0	0	0	0	0	0	0
2	10	20	30	40	50	60	70	80	90	100
3	20	40	60	80	100	120	140	160	180	200
4	30	60	90	120	150	180	210	240	270	300
5	40	80	120	160	200	240	280	320	360	400
6	50	100	150	200	250	300	350	400	450	500
7	60	120	180	240	300	360	420	480	540	600
8	70	140	210	280	350	420	490	560	630	700
9	80	160	240	320	400	480	560	640	720	800
10	90	180	270	360	450	540	630	720	810	900
20	190	380	570	760	950	1140	1330	1520	1710	1900
30	290	580	870	1160	1450	1740	2030	2320	2610	2900
40	390	780	1170	1560	1950	2340	2730	3120	3510	3900
50	490	980	1470	1960	2450	2940	3430	3920	4410	4900

Table 18.15 Trigonometric tables

Angle(x) degrees	Radians	Sin(x)	Cos(x)	Tan(x)	Angle(x) degrees	Radians	Sin(x)	Cos(x)	Tan(x)
1	0.0175	0.0175	0.9998	0.0175	46	0.8029	0.7193	0.6947	1.0355
2	0.0349	0.0349	0.9994	0.0349	47	0.8203	0.7314	0.6820	1.0724
3	0.0524	0.0523	0.9986	0.0524	48	0.8378	0.7431	0.6691	1.1106
4	0.0698	0.0698	0.9976	0.0699	49	0.8552	0.7547	0.6561	1.1504
5	0.0873	0.0872	0.9962	0.0875	50	0.8727	0.7660	0.6428	1.1918
6	0.1047	0.1045	0.9945	0.1051	51	0.8901	0.7771	0.6293	1.2349
7	0.1222	0.1219	0.9925	0.1228	52	0.9076	0.7880	0.6157	1.2799
8	0.1396	0.1392	0.9903	0.1405	53	0.9250	0.7986	0.6018	1.3270
9	0.1571	0.1564	0.9877	0.1584	54	0.9425	0.8090	0.5878	1.3764
10	0.1745	0.1736	0.9848	0.1763	55	0.9599	0.8192	0.5736	1.4281
11	0.1920	0.1908	0.9816	0.1944	56	0.9774	0.8290	0.5592	1.4826
12	0.2094	0.2079	0.9781	0.2126	57	0.9948	0.8387	0.5446	1.5399
13	0.2269	0.2250	0.9744	0.2309	58	1.0123	0.8480	0.5299	1.6003
14	0.2443	0.2419	0.9703	0.2493	59	1.0297	0.8572	0.5150	1.6643
15	0.2618	0.2588	0.9659	0.2679	60	1.0472	0.8660	0.5000	1.7321
16	0.2793	0.2756	0.9613	0.2867	61	1.0647	0.8746	0.4848	1.8040
17	0.2967	0.2924	0.9563	0.3057	62	1.0821	0.8829	0.4695	1.8807
18	0.3142	0.3090	0.9511	0.3249	63	1.0996	0.8910	0.4540	1.9626
19	0.3316	0.3256	0.9455	0.3443	64	1.1170	0.8988	0.4384	2.0503
20	0.3491	0.3420	0.9397	0.3640	65	1.1345	0.9063	0.4226	2.1445
21	0.3665	0.3584	0.9336	0.3839	66	1.1519	0.9135	0.4067	2.2460
22	0.3840	0.3746	0.9272	0.4040	67	1.1694	0.9205	0.3907	2.3559
23	0.4014	0.3907	0.9205	0.4245	68	1.1868	0.9272	0.3746	2.4751
24	0.4189	0.4067	0.9135	0.4452	69	1.2043	0.9336	0.3584	2.6051
25	0.4363	0.4226	0.9063	0.4663	70	1.2217	0.9397	0.3420	2.7475
26	0.4538	0.4384	0.8988	0.4877	71	1.2392	0.9455	0.3256	2.9042
27	0.4712	0.4540	0.8910	0.5095	72	1.2566	0.9511	0.3090	3.0777
28	0.4887	0.4695	0.8829	0.5317	73	1.2741	0.9563	0.2924	3.2709
29	0.5061	0.4848	0.8746	0.5543	74	1.2915	0.9613	0.2756	3.4874
30	0.5236	0.5000	0.8660	0.5774	75	1.3090	0.9659	0.2588	3.7321
31	0.5411	0.5150	0.8572	0.6009	76	1.3265	0.9703	0.2419	4.0108
32	0.5585	0.5299	0.8480	0.6249	77	1.3439	0.9744	0.2250	4.3315
33	0.5760	0.5446	0.8387	0.6494	78	1.3614	0.9781	0.2079	4.7046
34	0.5934	0.5592	0.8290	0.6745	79	1.3788	0.9816	0.1908	5.1446
35	0.6109	0.5736	0.8192	0.7002	80	1.3963	0.9848	0.1736	5.6713
36	0.6283	0.5878	0.8090	0.7265	81	1.4137	0.9877	0.1564	6.3138
37	0.6458	0.6018	0.7986	0.7536	82	1.4312	0.9903	0.1392	7.1154
38	0.6632	0.6157	0.7880	0.7813	83	1.4486	0.9925	0.1219	8.1443
39	0.6807	0.6293	0.7771	0.8098	84	1.4661	0.9945	0.1045	9.5144
40	0.6981	0.6428	0.7660	0.8391	85	1.4835	0.9962	0.0872	11.4301
41	0.7156	0.6561	0.7547	0.8693	86	1.5010	0.9976	0.0698	14.3007
42	0.7330	0.6691	0.7431	0.9004	87	1.5184	0.9986	0.0523	19.0811
43	0.7505	0.6820	0.7314	0.9325	88	1.5359	0.9994	0.0349	28.6363
44	0.7679	0.6947	0.7193	0.9657	89	1.5533	0.9998	0.0175	57.2900
45	0.7854	0.7071	0.7071	1.0000	90	1.5708	1.0000	0.0000	infinity

Table 18.16 Square cube root table

Number	Squares	Cubes	Square Root	Cube Root	Number	Squares	Cubes	Square Root	Cube Root
1	1	1	1.0000	1.0000	26	676	17576	5.0990	2.9622
2	4	8	1.4142	1.2599	27	729	19683	5.1962	2.9997
3	9	27	1.7321	1.4422	28	784	21952	5.2915	3.0363
4	16	64	2.0000	1.5873	29	841	24389	5.3852	3.0720
5	25	125	2.2361	1.7099	30	900	27000	5.4772	3.1069
6	36	216	2.4495	1.8170	31	961	29791	5.5678	3.1410
7	49	343	2.6458	1.9128	32	1024	32768	5.6569	3.1744
8	64	512	2.8284	1.9999	33	1089	35937	5.7446	3.2072
9	81	729	3.0000	2.0799	34	1156	39304	5.8310	3.2392
10	100	1000	3.1623	2.1543	35	1225	42875	5.9161	3.2707
11	121	1331	3.3166	2.2238	36	1296	46656	6.0000	3.3015
12	144	1728	3.4641	2.2892	37	1369	50653	6.0828	3.3318
13	169	2197	3.6056	2.3511	38	1444	54872	6.1644	3.3616
14	196	2744	3.7417	2.4099	39	1521	59319	6.2450	3.3908
15	225	3375	3.8730	2.4660	40	1600	64000	6.3246	3.4195
16	256	4096	4.0000	2.5196	41	1681	68921	6.4031	3.4478
17	289	4913	4.1231	2.5710	42	1764	74088	6.4807	3.4756
18	324	5832	4.2426	2.6205	43	1849	79507	6.5574	3.5030
19	361	6859	4.3589	2.6681	44	1936	85184	6.6332	3.5299
20	400	8000	4.4721	2.7141	45	2025	91125	6.7082	3.5564
21	441	9261	4.5826	2.7586	46	2116	97336	6.7823	3.5826
22	484	10648	4.6904	2.8018	47	2209	103823	6.8557	3.6084
23	529	12167	4.7958	2.8436	48	2304	110592	6.9282	3.6338
24	576	13824	4.8990	2.8842	49	2401	117649	7.0000	3.6588
25	625	15625	5.0000	2.9237	50	2500	125000	7.0711	3.6836

Table 18.16 Square cube root table continued

Number	Squares	Cubes	Square Root	Cube Root	Number	Squares	Cubes	Square Root	Cube Root
51	2601	132651	7.1414	3.7079	76	5776	438976	8.7178	4.2352
52	2704	140608	7.2111	3.7320	77	5929	456533	8.7750	4.2537
53	2809	148877	7.2801	3.7558	78	6084	474552	8.8318	4.2720
54	2916	157464	7.3485	3.7793	79	6241	493039	8.8882	4.2902
55	3025	166375	7.4162	3.8024	80	6400	512000	8.9443	4.3082
56	3136	175616	7.4833	3.8253	81	6561	531441	9.0000	4.3261
57	3249	185193	7.5498	3.8480	82	6724	551368	9.0554	4.3438
58	3364	195112	7.6158	3.8704	83	6889	571787	9.1104	4.3614
59	3481	205379	7.6811	3.8925	84	7056	592704	9.1652	4.3789
60	3600	216000	7.7460	3.9143	85	7225	614125	9.2195	4.3962
61	3721	226981	7.8102	3.9360	86	7396	636056	9.2736	4.4133
62	3844	238328	7.8740	3.9573	87	7569	658503	9.3274	4.4304
63	3969	250047	7.9373	3.9785	88	7744	681472	9.3808	4.4473
64	4096	262144	8.0000	3.9994	89	7921	704969	9.4340	4.4641
65	4225	274625	8.0623	4.0202	90	8100	729000	9.4868	4.4807
66	4356	287496	8.1240	4.0407	91	8281	753571	9.5394	4.4973
67	4489	300763	8.1854	4.0610	92	8464	778688	9.5917	4.5137
68	4624	314432	8.2462	4.0811	93	8649	804357	9.6437	4.5300
69	4761	328509	8.3066	4.1010	94	8836	830584	9.6954	4.5461
70	4900	343000	8.3666	4.1207	95	9025	857375	9.7468	4.5622
71	5041	357911	8.4261	4.1402	96	9216	884736	9.7980	4.5782
72	5184	373248	8.4853	4.1596	97	9409	912673	9.8489	4.5940
73	5329	389017	8.5440	4.1787	98	9604	941192	9.8995	4.6097
74	5476	405224	8.6023	4.1977	99	9801	970299	9.9499	4.6254
75	5625	421875	8.6603	4.2166	100	10000	1000000	10.0000	4.6409

Notes:

Notes:

Notes:

